

The logo consists of three nested, red, L-shaped geometric forms that create a sense of depth and perspective, resembling a stylized 'M' or a series of steps. The forms are centered in the upper half of the page.

MagiCAD Create

Release Notes

MagiCAD Create 2023.01 – Release notes

New features

No new major features were added.

Fixes and improvements

- Fixed mixing unit connection infos and material mappings.
- Fixed duplicate material properties in radiators.
- Fixed sprinklers' allowed installation directions.

MagiCAD Create 2022.05 – Release notes

New features

Venturi valve has been added to MagiCAD Create.

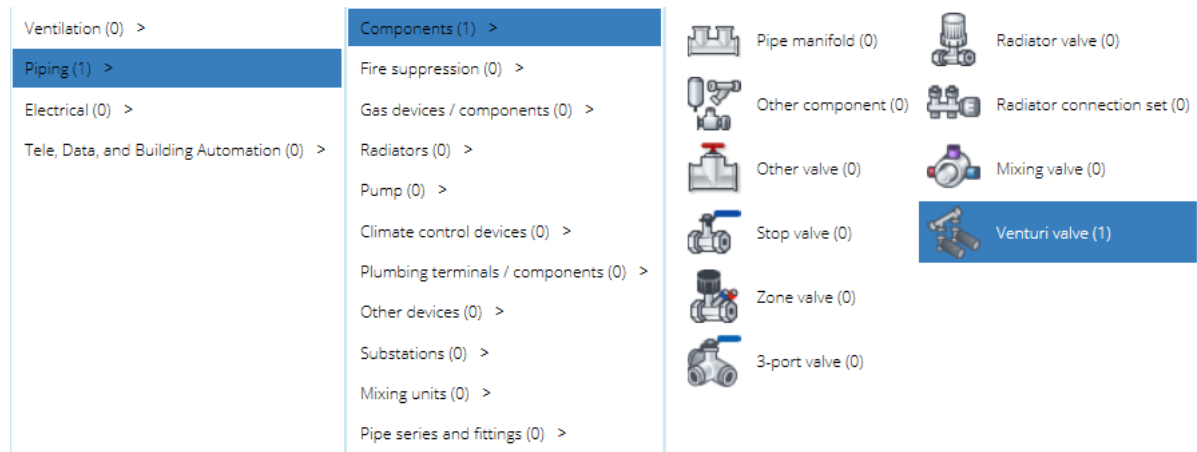

Fixes and improvements

- Improved the way behaviours are set. It is now possible to detect whether connection ports are aligned on the same line.
- Updating Qmodel should always update family versionId to all affected products.
- Only Qmodel change should now be allowed for “not editable” products.
- Various fixes for sizing mode change
 - Voltage value is not lost in the process
 - Qmodel parameters are correctly passed from family to the variants.
- When merging products from another DB. Products with same ID were not recognized as same products if they had different name.
- Various fixes for exclude application values.

MagiCAD Create 2022.02.1 – Release notes

Fixes and improvements

- Electrical connection was saved to connectionPort attribute with various products
- MCC crashed when trying to save PumpType other than fixed to empty PumpTemplate
- TextBoxes for electrical data would not allow decimals due to instant validation
- German, Spanish and French languages would crash when trying to open product due to error in translations.
- Adding special exclude applications should now work properly.
- MCC would not remember level of detail selected when switching between products and CAT models where not drawn correctly

MagiCAD Create 2022.02 – Release notes

Fixes and improvements



- Fixes for selecting multiple products in product list.
- Added warnings and validations for setting electrical data
- Minimum Magicad version is now visible for the whole database.
- MCC can be launched directly from qbd -file.
- Fix for radiator technical data disappearing when bringing to Create
- Fixed “Use these dimensions in product -preview” can now only be set to one variant, and value wont be copied.
- Fix for PumpType not saving
- Rfa file name can now be set for Cable tray fittings
- Fix for Codestruct did not update when ProductCode was changed
- Advanced data is always opened for Admin users
- Fix for Diameter setting was not working properly for 3th party products.
- Added Equivalent length for pipe joints

New features

Material colors can now be edited in MCC

- Copy will set current variant materials to all variants.
- Reset will get original materials from Qmodel.
- Materials can be pasted from Clip Board in RGB ex. 233,45,120 by selecting row and pasting with ctrl+v

Material parameters

Name	Id	Red	Green	Blue	Trans	Shine	
White	1	255	255	255	0	50	
Matt black	2	255	128	0	0	0	
Grey	3	192	192	192	0	50	

Reset

Copy

MagiCAD Create 2021.10.1 – Release notes

Fixes and improvements

- Fixed Angle Pipe component behaviour

MagiCAD Create 2021.10 – Release notes

New features

Angle pipe components for MagiCAD for AutoCAD

Added support for pipe components for MagiCAD for AutoCAD.

Fixes and improvements

- Improvements to other pipe components.

MagiCAD Create 2021.6 – Release notes

New features

Define duct bend length class by r/d or rin

Duct bend length class can now be defined by r/d or rin for rectangle ducts and by r/d for round ducts.

Length class

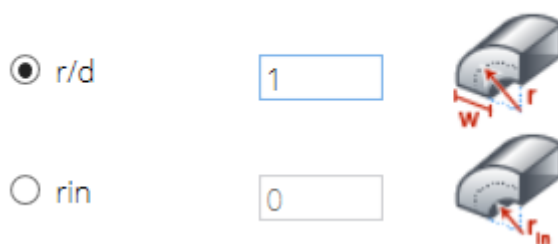

r/d:

- Short bend: greater than or equal to 0,5 and less than 0,8.
- Medium bend: greater than 0,8 and less than 1,25.
- Long bend: greater than or equal to 1,25.

rin:

- Distance in mm.

Effective area for radiators

Effective area can now be defined for radiators by first check the check box “use effective areas” and then filling the data in the effective area tab. New effective areas are added by adding new sizes in the 3D tab.

3D Technical data (optional) **Effective area**

Dimensions

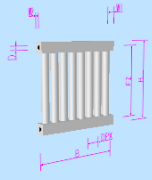

MAGIP_

Dimensions [mm] and parameters

Description	Label	Value
depth	W1	40
pipe connection position	W2	20
pipe diameter	D	15
section diameters	RM	30
x location bottom connection	PX	62
gap between bottom pipe	DPX	50

Use effective area

Heights and lengths [mm]

Preview of codes and sizes [mm]

Code	Length (B)	Height (H)
testpatteri2-0100-0100	100	100
testpatteri2-0100-0200	200	100
testpatteri2-0111-0111	111	111
testpatteri2-0222-0222	222	222

Duct connection type rework

The connection type selections for duct series and fittings have been updated.

Integrated radiator valves can now be created

When creating a new radiator valves, MagiCAD Create now asks to select the device type, if the “use templates for new products” option is unchecked in the settings menu.

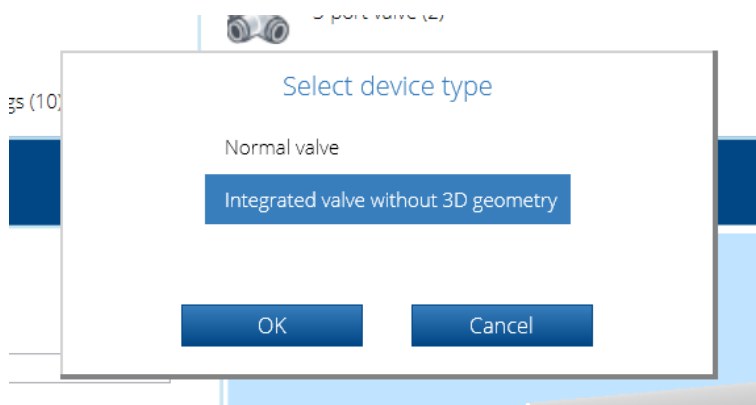

Settings

Check for updates automatically

Check for updates

Manufacturer

Website

Manufacturer name abbreviation

Database password

Use templates with new products

Online product database locations

Europe ▾

Default language

English ▾

User interface language

English ▾

OK

Cancel

Fixes and improvements

- Fixed two problems related to installation direction.
- Fixed problem with other duct components that have additional non-ventilation connections.
- Fixed problem with decimal values in distribution boxes.
- Various smaller fixes.

MagiCAD Create 2021.2.1 – Release notes

Fixes and improvements

- Import/export fixes

MagiCAD Create 2021.2 – Release notes

New features

Mixing valve

Mixing valve has been added to MagiCAD Create.

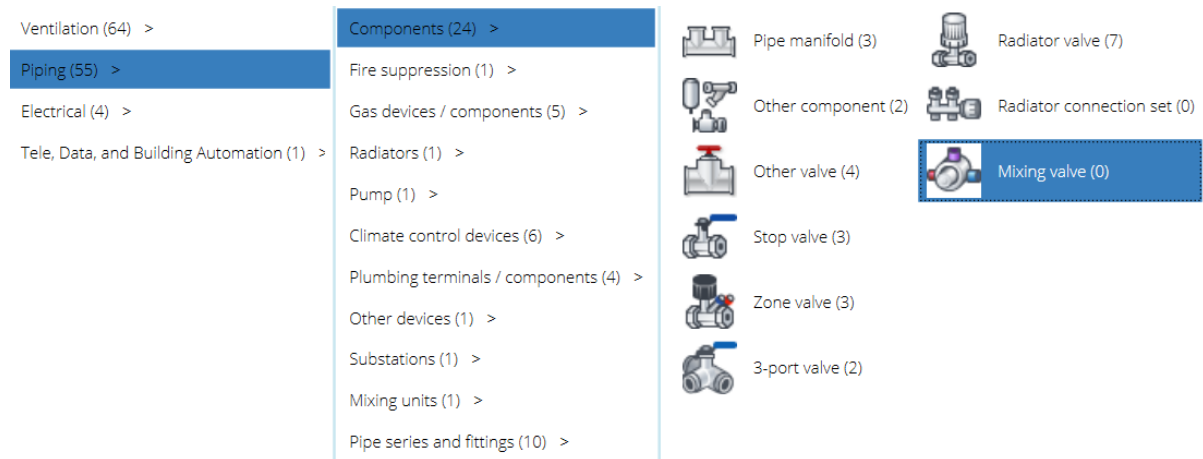

Radiator connection set

Radiator connection set has been added to MagiCAD Create.

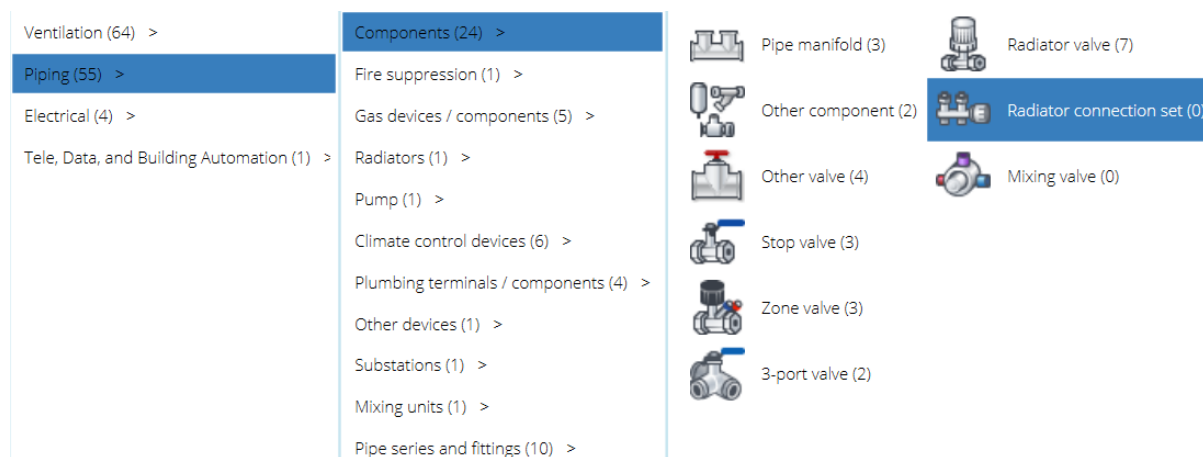

Spanish language

MagiCAD Create now supports Spanish language.

FIPS support

MagiCAD Create now supports Windows FIPS mode.

Fixes and improvements

- The maximum amount of duct sizes has been increased from 932 to 5000.
- Fixed a problem, which caused changes to data sometimes go undetected which resulted in the save button not activating.
- Fixed a problem with decimal values in electrical product sizes.
- Import/export fixes
- Various smaller fixes

MagiCAD Create 2020.10 – Release notes

New features

New pump types

New pump types have been added with different curves. The new types are called “Stepless” and “Stepped”. The old pumps are now known as “Fixed Pumps”. The type can be selected from product basic data:

Basic data

Code

L_32 ...-100 VS - fixed (old and new)

Description (English)

INLINE-pumps with integrated VS-frequency converter,

Pump type

- Fixed
- Stepless
- Stepped
- Advanced

An example of stepped pump curve. At least two points per rpm and at least two different rpms are needed:

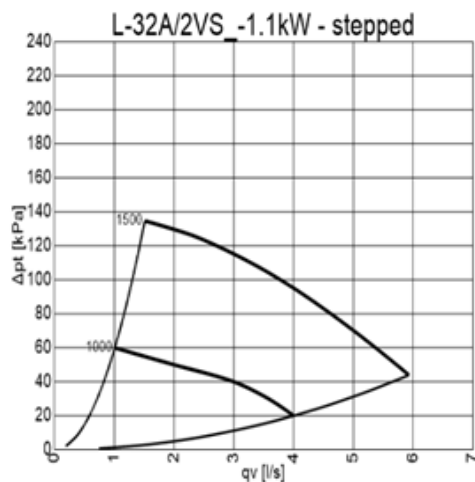

Diagram limits

min qv l/s min Δpt kPa
 max qv l/s max Δpt kPa

qv [l/s]	Δpt [kPa]	Rpm
1	60	1000
2	50	1000
3	40	1000
4	20	1000
1	140	1500
1.3	136.9	1500
2.3	126.2	1500
3.2	111.6	1500
4	95.1	1500
5	70.2	1500
6	42	1500

Add

Delete

Clear

Operational area limits

min qv l/s min Δpt kPa
 max qv l/s max Δpt kPa

Pressure independent radiator valve

New type of radiator valve has been added. Pressure independent radiator valve allows creation of radiator valves with similar data as the pressure independent zone valve. The type can be selected from product basic data:

Basic data

Code

PIRVP

Description (English)

Pressure independent radiator valve product

Valve type

- Normal radiator valve
- Pressure independent radiator valve
 - Interpolation allowed

Advanced

Fixes and improvements



- Drainage pipe segment UI fixes
- Import/export fixes
- Various smaller fixes

MagiCAD Create 2020.5 – Release notes

New features

Gas valve

Gas valve has been added to MagiCAD Create.

Ventilation (55) >	Components (19) >	 Gas component (2)
Piping (47) >	Fire suppression (1) >	 Gas device (3)
Electrical (3) >	Gas devices / components (5) >	 Gas valve (0)
Tele, Data, and Building Automation (1) >	Radiators (1) >	
	Pump (0) >	
	Climate control devices (5) >	
	Plumbing terminals / components (4) >	
	Other devices (1) >	
	Substations (1) >	
	Mixing units (1) >	
	Pipe series and fittings (9) >	

Back box

Back box has been added to MagiCAD Create.

Ventilation (55) >	Electrical (3) >	 Back box (0)
Piping (47) >	Cable Tray Series and Fittings (0) >	
Electrical (3) >	Conduit Series and Fittings (0) >	
Tele, Data, and Building Automation (1) >	Other cable route products (0) >	

Custom values for sprinkler nominal release temperature

Sprinkler nominal release temperature can now be set with either the old preset values or completely custom values.

3D Technical data (optional)

Technical data

Nominal release temperature	<input type="text" value="99"/>	°C Use custom value <input checked="" type="checkbox"/>
Response class	<input type="text" value="QR"/>	
k-factor	<input type="text" value="80"/>	

Fixes and improvements

- Added support for new types of substations
- Shape attribute should now be updated correctly with drainage devices
- Connection port sizes attribute should no longer be created when not needed
- Fixed a problem that caused Lp10(A) calculations to give wrong values with small octave band values.
- Various smaller fixes

MagiCAD Create 2020.2 – Release notes

New features

3-Port Valve

3-port valve has been added to MagiCAD Create.

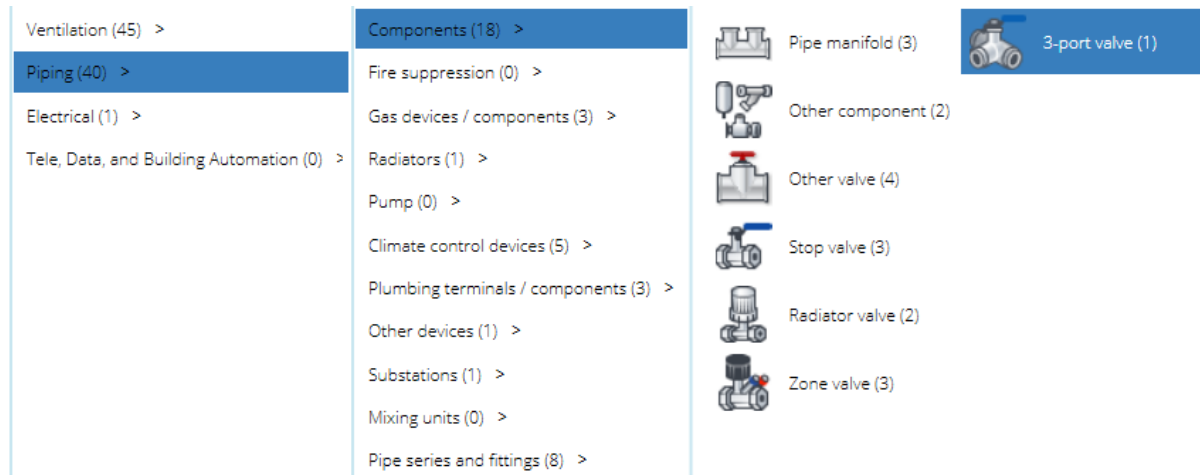

New warning and validation for electrical products

Voltage now shows a warning if it is not set. Saving is still possible.

Active power W

Power supply

Phase 1~ 2~ 3~

Voltage V 

cos Φ

If active power is set, then voltage must be also set. In this case saving is not possible until voltage is set and is not 0.

Active power W

Power supply

Phase 1~ 2~ 3~

Voltage V

cos Φ Value cannot be 0.

Fixes and improvements

- Export/import should now handle electrical connectors correctly for fancoils.
- Unticking the “variants share the same data” check box on some products caused pressure and sound data rows to double. This has now been fixed.
- Fixed ordering of variant list in Single Product Mode.
- Fixed problem with Chinese characters sometimes not appearing correctly.
- Drainage components with 90 degree angle should now set correct behaviour attribute values.

MagiCAD Create 2019.12 – Release notes

New features

- Added new inputs for pipe series:
 - Thermal conductivity
 - Flexible pipe

Pipe sizes

Size	Din	Dout

Material code

Roughness for piping

Roughness for fresh water

Hazen-Williams factor

Thermal conductivity W/mK

Flexible pipe

Data for flexible sprinkler pipes

Fixes and improvements

- Fixed a problem that caused copying variants of certain product classes to crash the program.
- Fixed a problem that caused the program to crash when editing filter.
- Connection ID for qpdElectConnDimData attribute is now correctly updated.
- The number of variants shown on product card is now automatically updated when creating, deleting or copying variants.
- Several export/import fixes and improvements
- Negative values are no longer accepted in the count of vanes.

MagiCAD Create 2019.9 – Release notes

New features

Single Product Mode now supports third party RFAs.

New product classes

Pipe tap and drainage N-branch have been added.

MagiCAD Create 2019.5 – Release notes

New features

Level of Detail (LOD) support

MagiCAD Create now support different detail modes for models. The program will show the highest available detail mode. Current detail mode is shown in the upper left corner of the the model.

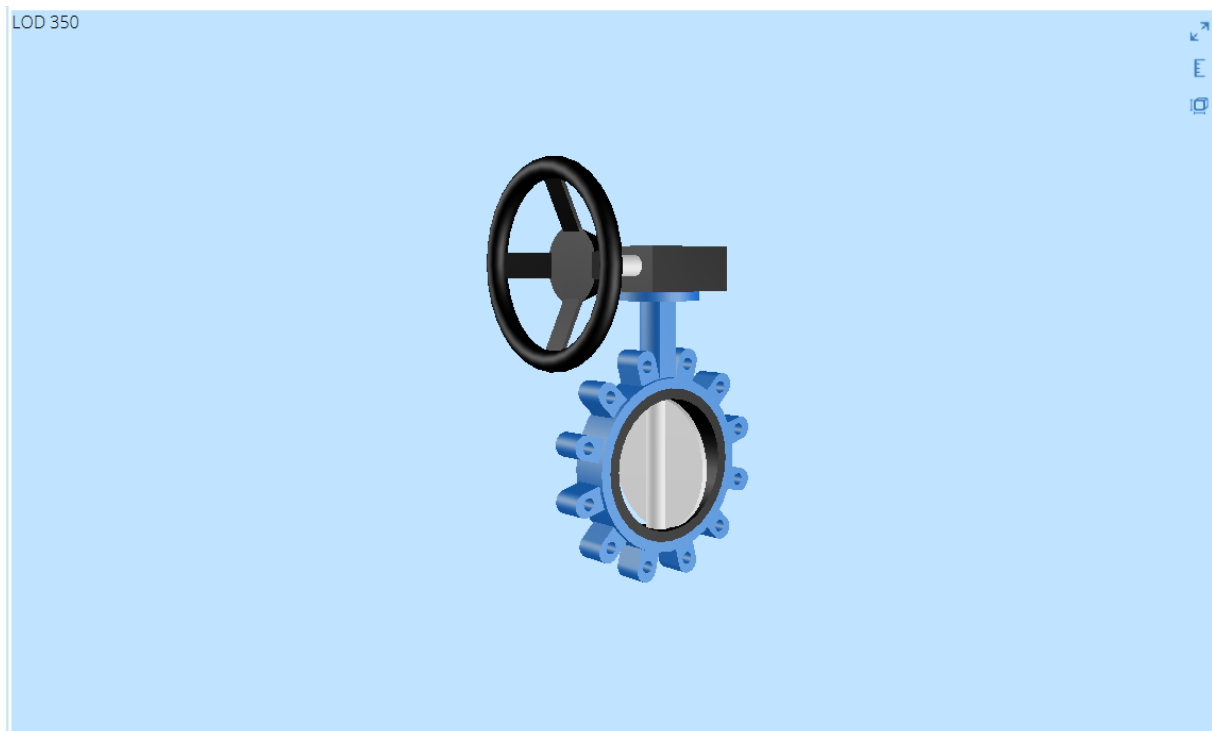

Constant Pressure Valve

New subtype of zone valve, constant pressure valve has been added:

Product MagiCAD for Revit 2020 ->
ConstantPressureValve MagiCAD for AutoCAD 2020 ->

Basic data

Code

Description (English)

Valve type

- Balancing valve
- Automatic balancing valve
- Constant pressure valve
- Pressure independent valve
- Interpolation allowed

Advanced

Inlet pressure

Max inlet pressure kPa

Outlet pressure

Min outlet pressure kPa

Max outlet pressure kPa

Factory pressure (default value) kPa

Flow

Min flow l/s

Max flow l/s

Pressure limits

Min pressure difference (between inlet/outlet) kPa

Max pressure ratio

Ducts Series and Fittings

Ducts series and fittings have been added:

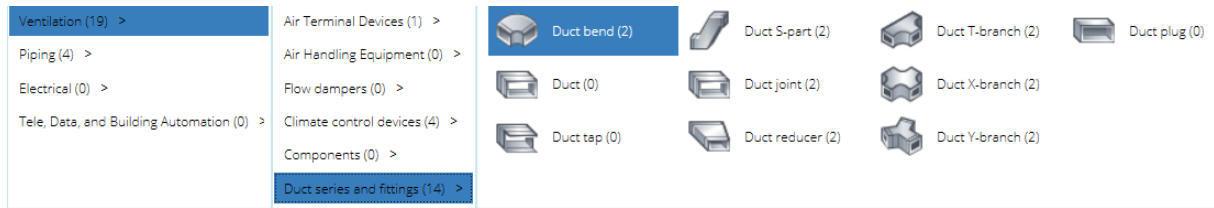

Cable Tray Series and Fittings

Cable tray series and fittings have been added:

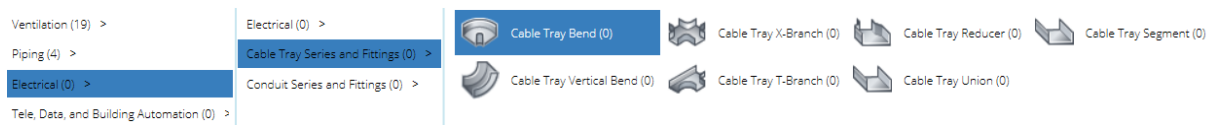

Conduit Series and Fittings

Conduit series and fittings have been added:

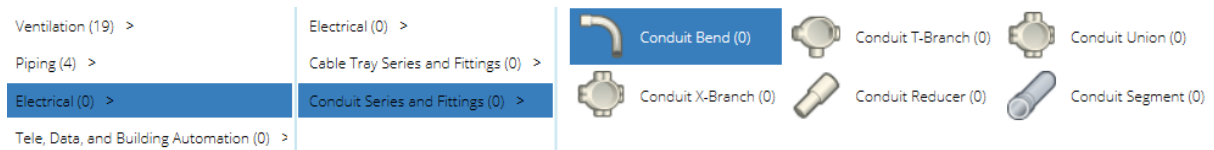

Single Product Mode

MagiCAD Create can now be launched from MagiCAD to edit single products.

MagiCAD Create 2019.3 – Release notes

New features

Duplicate database with new new ID values

The whole database can be copied so that new ID values are created for every product and variant. The Database duplication can be started from the main menu:

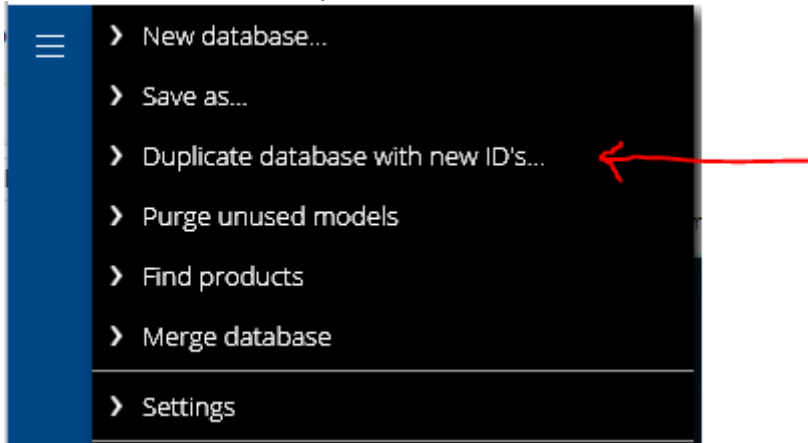

Zeta values have been added to Pipe fittings







Technical data

Equivalent lengths

DN1 [mm]	DN2 [mm]	Leqv branch [m]	Leqv run [m]
10	5	30	10

Add
Delete
Clear

Zeta values

DN (r)						
10	4	5	4.5	5.6	5.5	5.2

Add
Delete
Clear

The 'Export products to spreadsheet' feature extended

Local product codes and Variant descriptions can be exported now:

Export to spreadsheet

Product data

- Basic
- Descriptions
- Local product codes
 - China
 - Croatia
 - Czech Republic
 - Denmark
 - Estonia
 - Finland
 - France
 - Germany
 - Great Britain
 - Hungary
 - Iceland
 - Italy
 - Japan
- Web sites

Variant/Technical data

- Basic
- Descriptions
 - Arabic
 - Bosnian
 - Bulgarian
 - Chinese
 - Croatian
 - Czech
 - Danish
 - Dutch
 - English
 - English(US)
 - Estonian
 - Finnish
 - Flemish
- Diagram limits

AL	AM	AN	AO
Local product codes			
Finland	France	Germany	Great Britain

AQ	AR	AS	AT	AU	AV	AW
Product code						
	nsions and parameters	Weight	Manufacturer	Short product description. Max. 60 characters.		
				Danish	Dutch	English (mandatory)
circ-exh-grille-250						
	D=2					

IP-Class has been added to the basic export data in Electrical products:

C	D	E	F	G	H	I	J	K	L
Product data					Variant/Technical data				
3D geometry	Restricted to countries		IP Class		Product code	Dimensions and parameters	Weight	Manufacturer article number	IP Class
MAGIE_INTER-COMB-		Change	IP67		125A Switched-Interlocked	L=180;W=134;H=510;			

The exponent value for the pressure drop equation has been added also to the **Fan Coil Unit** and **Other device** product classes:

3D
Technical data (optional)
Power (opt.)

Heating

AIR-BARRIER-HORIZ-1000

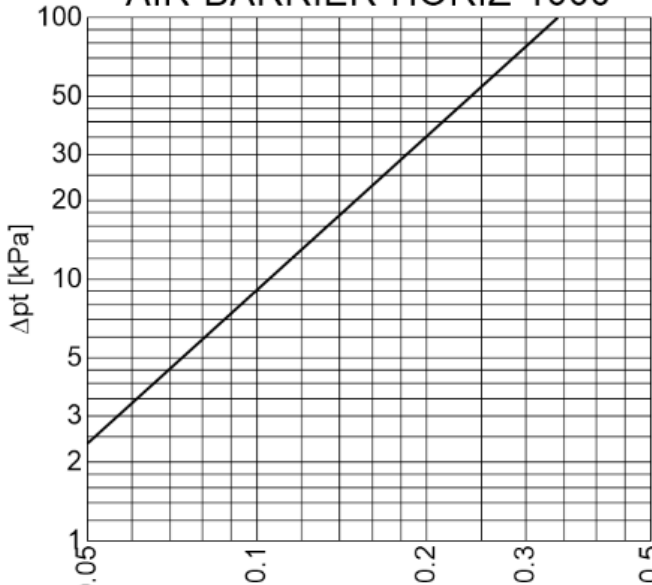

min qv l/s min Δpt kPa

max qv l/s max Δpt kPa

qv [l/s]	Δpt [kPa]
<input type="text" value="0.12"/>	<input type="text" value="13"/>

Clear

Pressure drop equation

$\Delta p = k \cdot q_v^e$ Exponent e:

MagiCAD Create 2019.1 – Release notes

Database groups improved

In this release, several database groups can be selected and the selected groups can be deleted in the **Database groups** dialog.

Also, the current operations in the **Database groups** dialog can be cancelled:

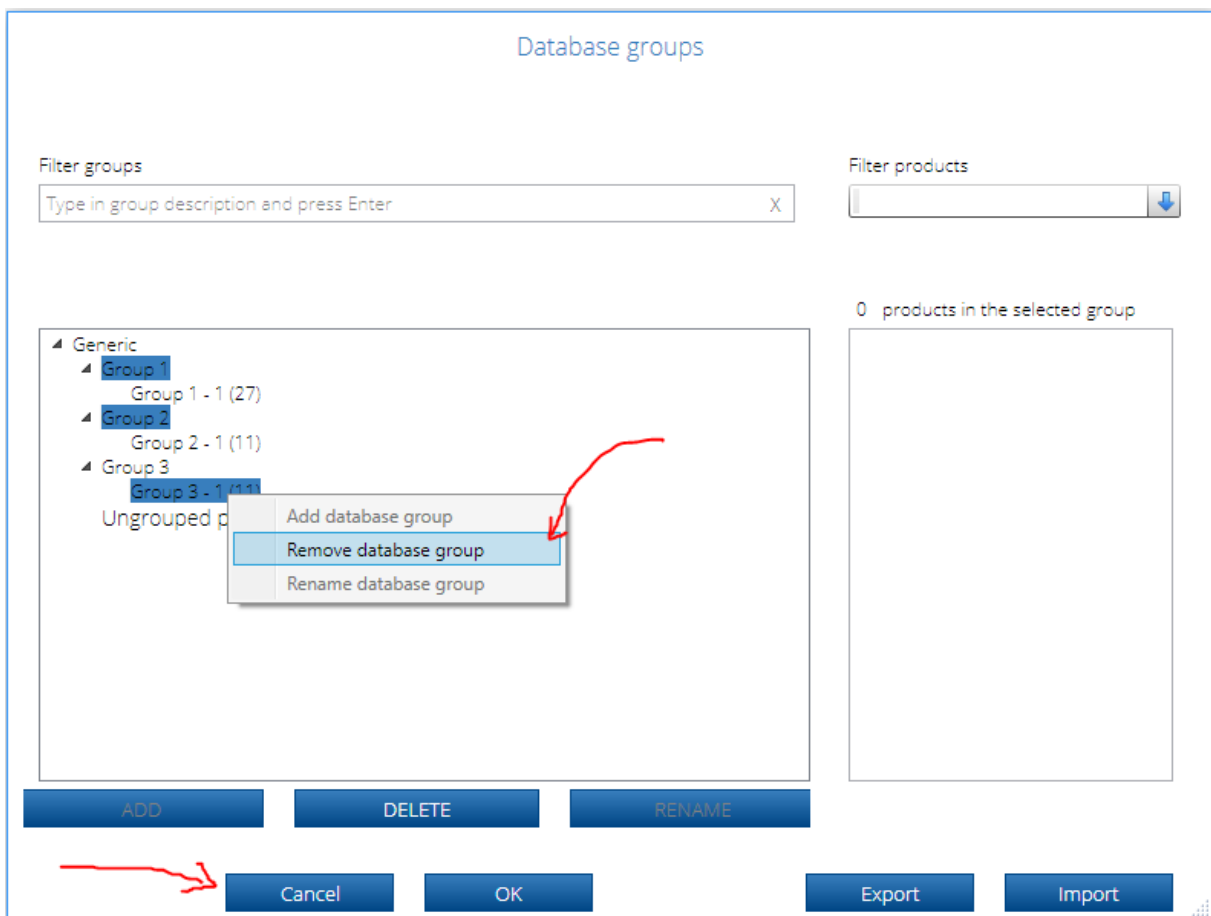

Validation improvements

Single curve is not acceptable in adjustable ventilation products.

Import products from spreadsheet - corrections

Fan speed changes are now handled correctly when importing **Air Handling Equipment** products.

Diagram limits are now exported correctly for **Air Handling Equipment** products.

Product selection improvements

The last, partially visible product at the end of the product list can now be selected as easily as all other products in the product list.

After the copy, the copied product is now always selected and visible at the product list.

MagiCAD Create 2018.10 – Release notes

New features

The modelling of Distribution box

The modelling of the Distribution box product type has been added.

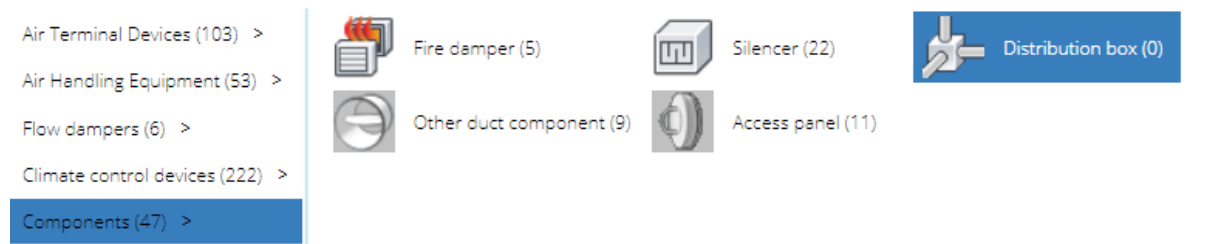

The 'Find product' feature extended

The products can now be found in the whole database, discipline, product category or product type. The **Find products** dialog can be opened from the Main menu:

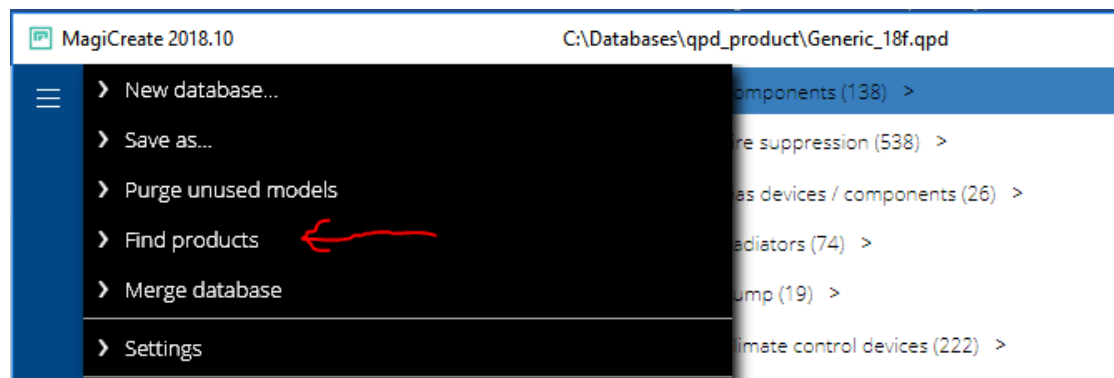

Or the product can be found by selecting Find products in the context menu at the selected level:

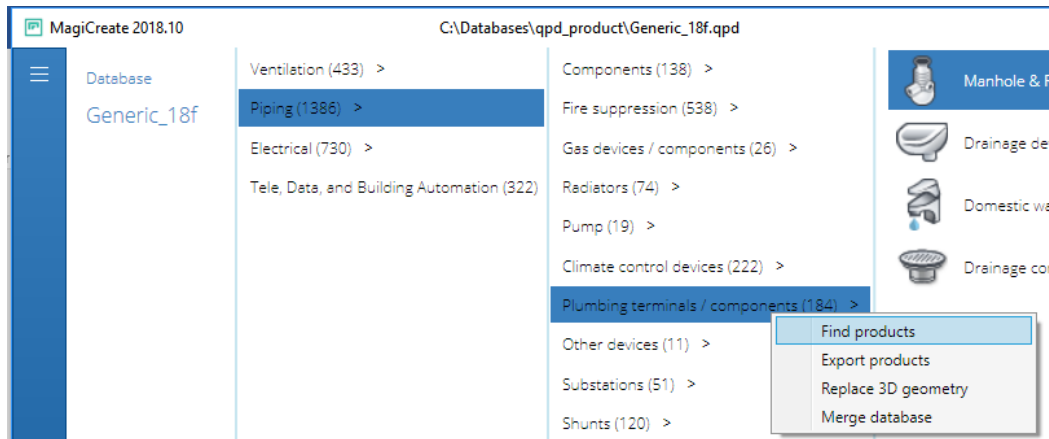

All products at the selected level (Discipline, product category or product type) are on the list of the **FindProducts** dialog:

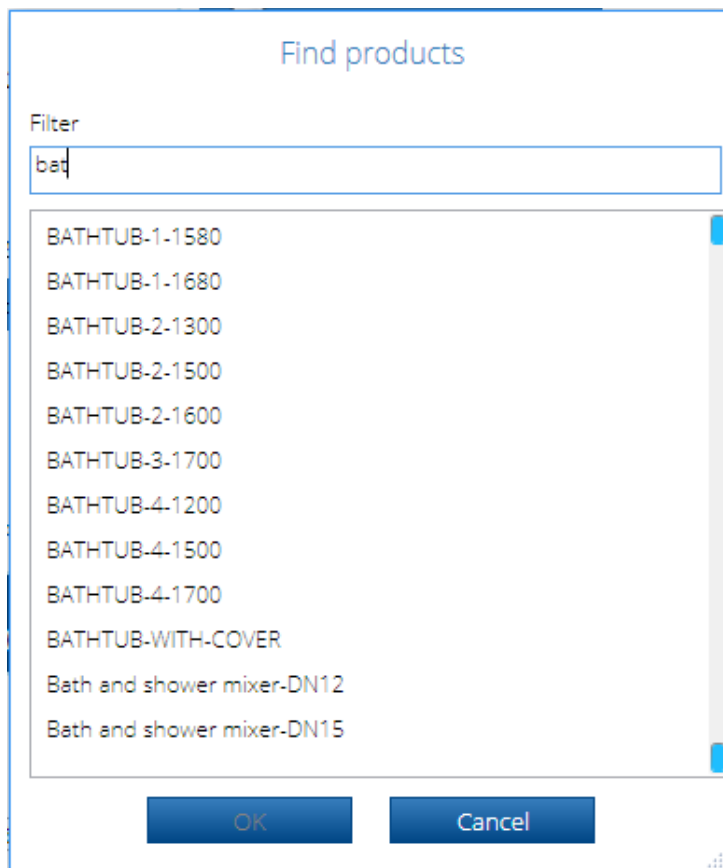

The **Find products** dialog can also be opened simply by pressing **CTRL+F**

Variant count visible in all products with several variants

The number of variants in the product can be seen on the product list.

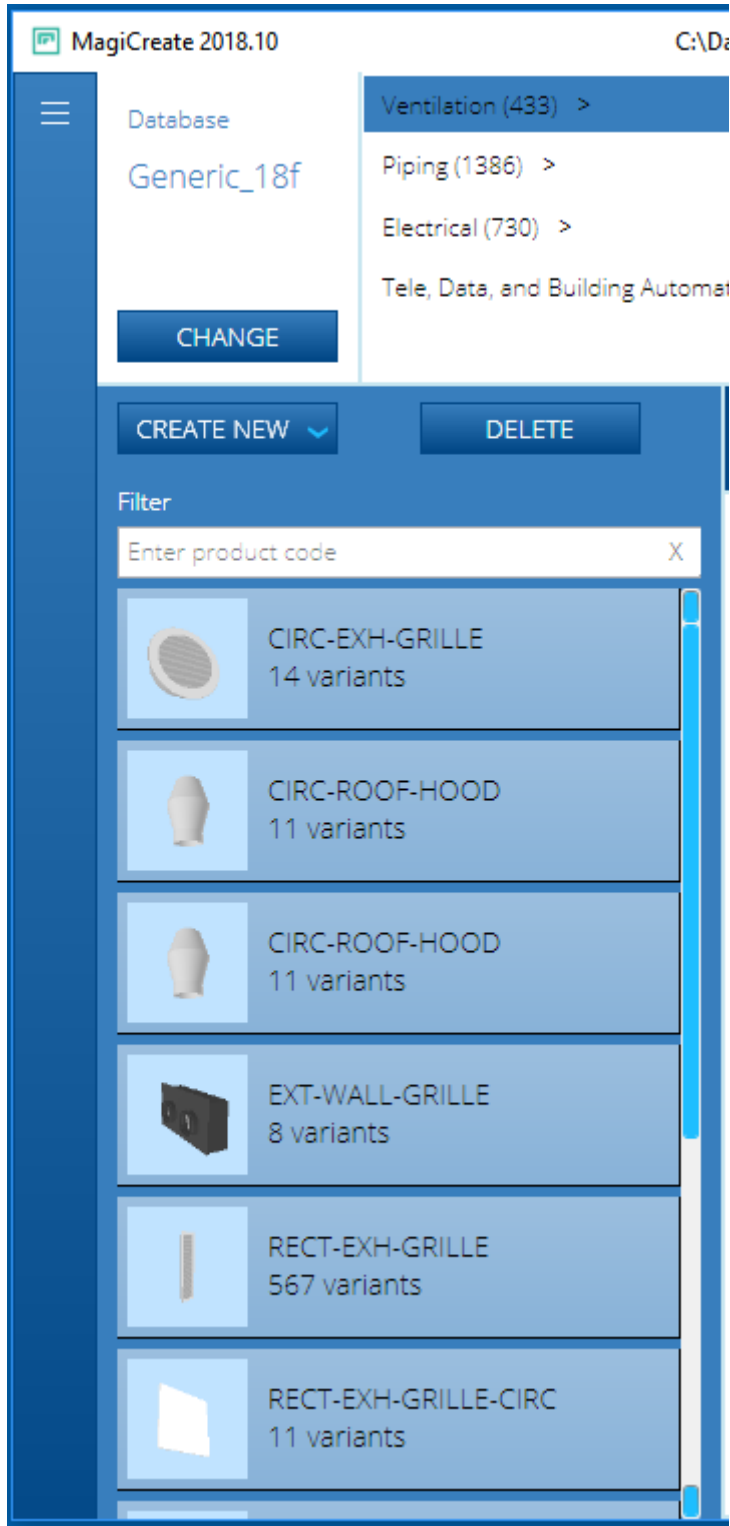

The 'Merge database' feature extended

The merge feature can be used for merging also distinct products.

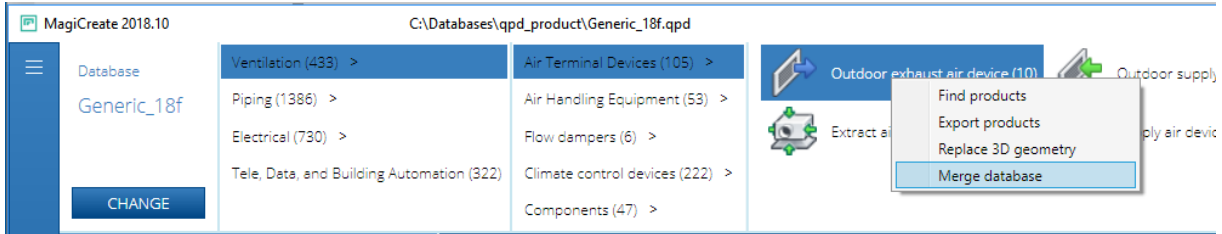

When selecting **Merge database** on the context menu, the selection dialog will open with a whole list of the products at the selected level. All products on the list can be selected, or if needed, only the ones that need to be merged.

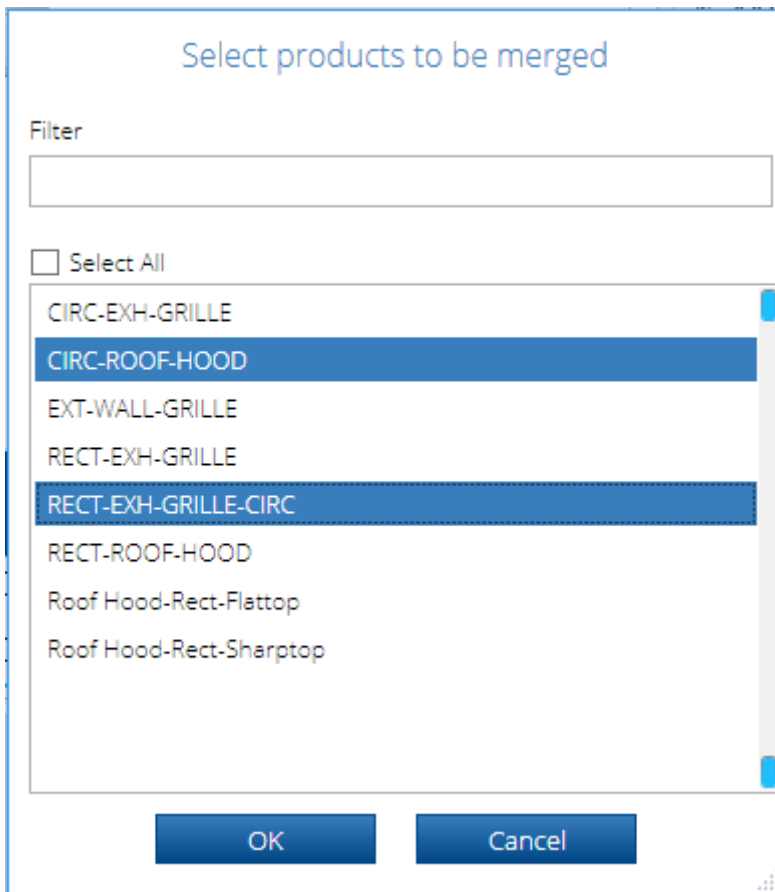

The 'Export products to spreadsheet' feature extended

Pressure data can be exported now also from the **Zone valve** product type.

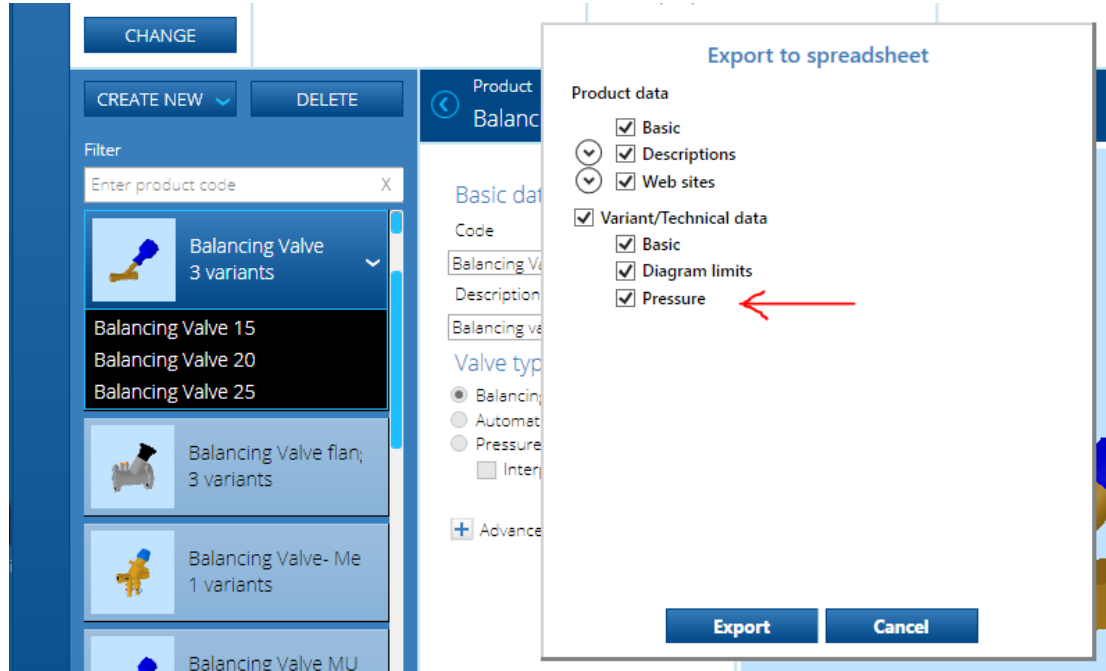

New excel sheet columns in the **Balancing valve** type:

Variant/Technical data			
Pressure data with volume control			
Adjustment	Flow	Pressure drop	Kv
2	0.014305	1	0.515
2.5	0.019	1	0.684

New excel sheet in the **Automatic Balancing valve** type:

Variant/Technical data				
Kvs values			Differential pressure range	
Flow	Pressure drop	Kv	PressureMin	PressureMax
0.027777	1	1	1	100

MagiCAD Create 2018.6 – Release notes

New features

Modelling of Pipe series and fittings

The modelling of Pipe series and fittings product category has been considerably extended in this release. Plenty of pipe fitting product types have been added.

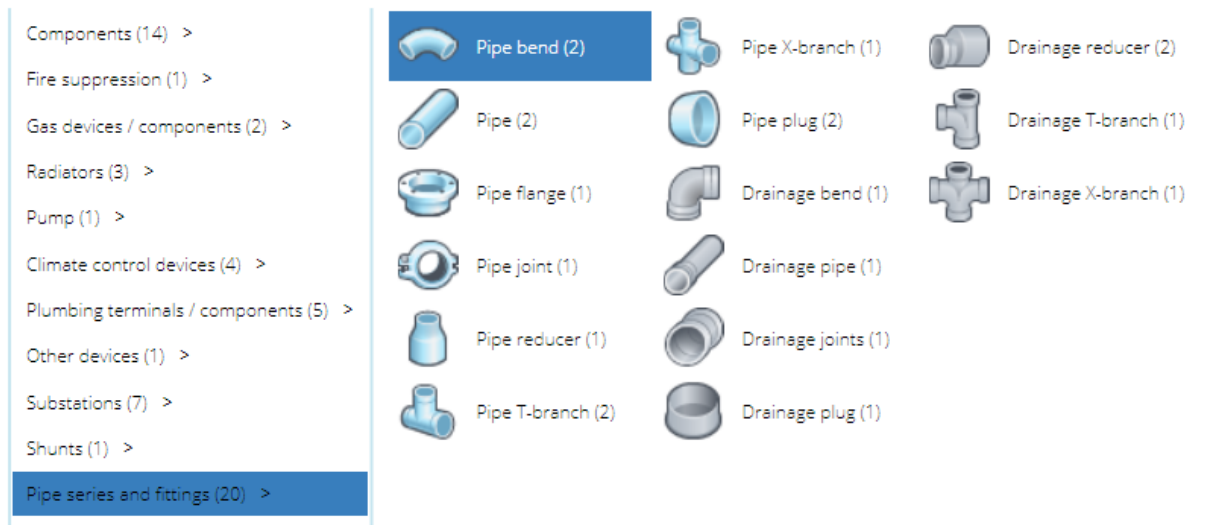

The 'Export products to spreadsheet' feature extended

Pressure data including Kv value can be exported from **Other component**, **Other valve** and **Stop valve** product types.

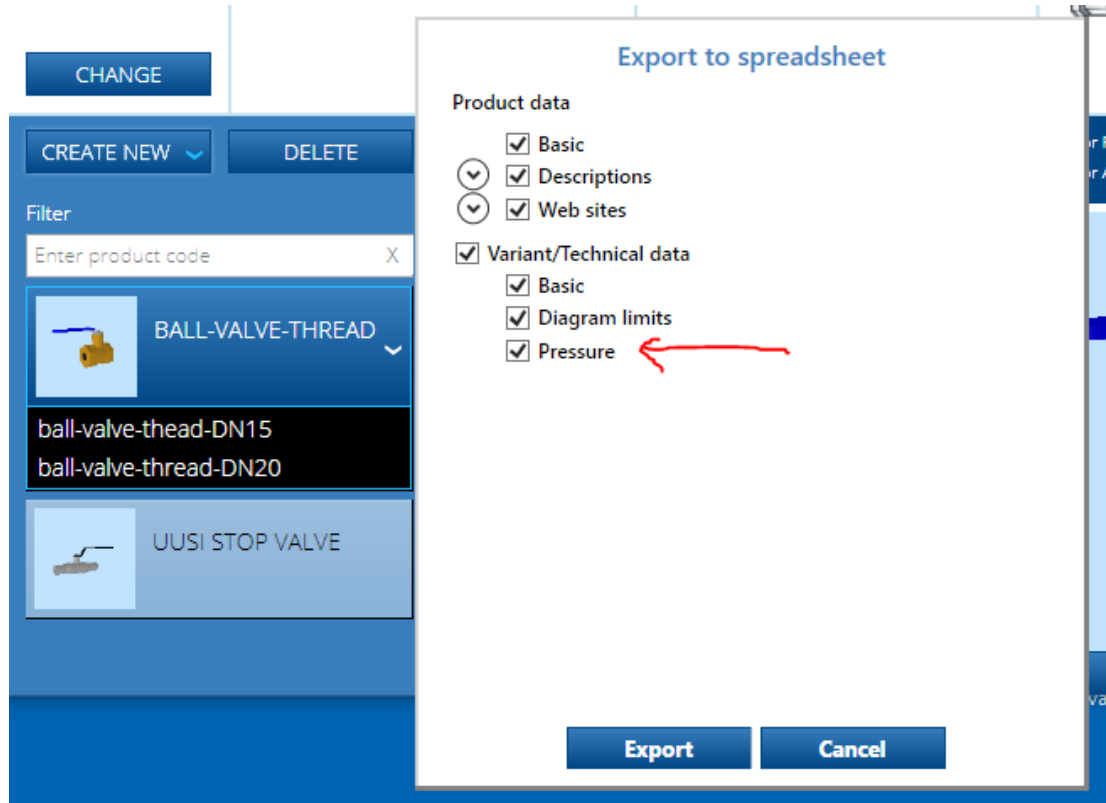

Variant/Technical data							
Manufacturer article number	Diagram limits (heating)				Pressure data without volume control		
	QvMin	QvMax	DpMin	DpMax	Flow	Pressure drop	Kv
	1	6	1	100	0.555555	1	20
	5	20	1	100	1.666667	1	60

Support for equivalent lengths for sprinkler pipes

Equivalent length values can be added for every pipe size:

MagiCAD for Revit 2014.4 ->
 MagiCAD for AutoCAD not supported

Technical data

Pipe sizes

Size	Din	Dout
40	40	45
50	50	55

Add
Delete
Clear

Material code

Roughness for piping

Roughness for fresh water

Hazen-Williams factor

Data for flexible sprinkler pipes

Equivalent length, DN Size: 50

Pipe length [mm]	Equivalent length [mm]
200	230
300	350

Add
Delete
Clear

Product copy from one product class to another extended

In **Other component**, **Other valve**, **Stop valve**, **Radiator valve** and **Zone valve**, it is now possible to copy products from one product class to another. Included variants and Power data can be selected, as well as the target class:

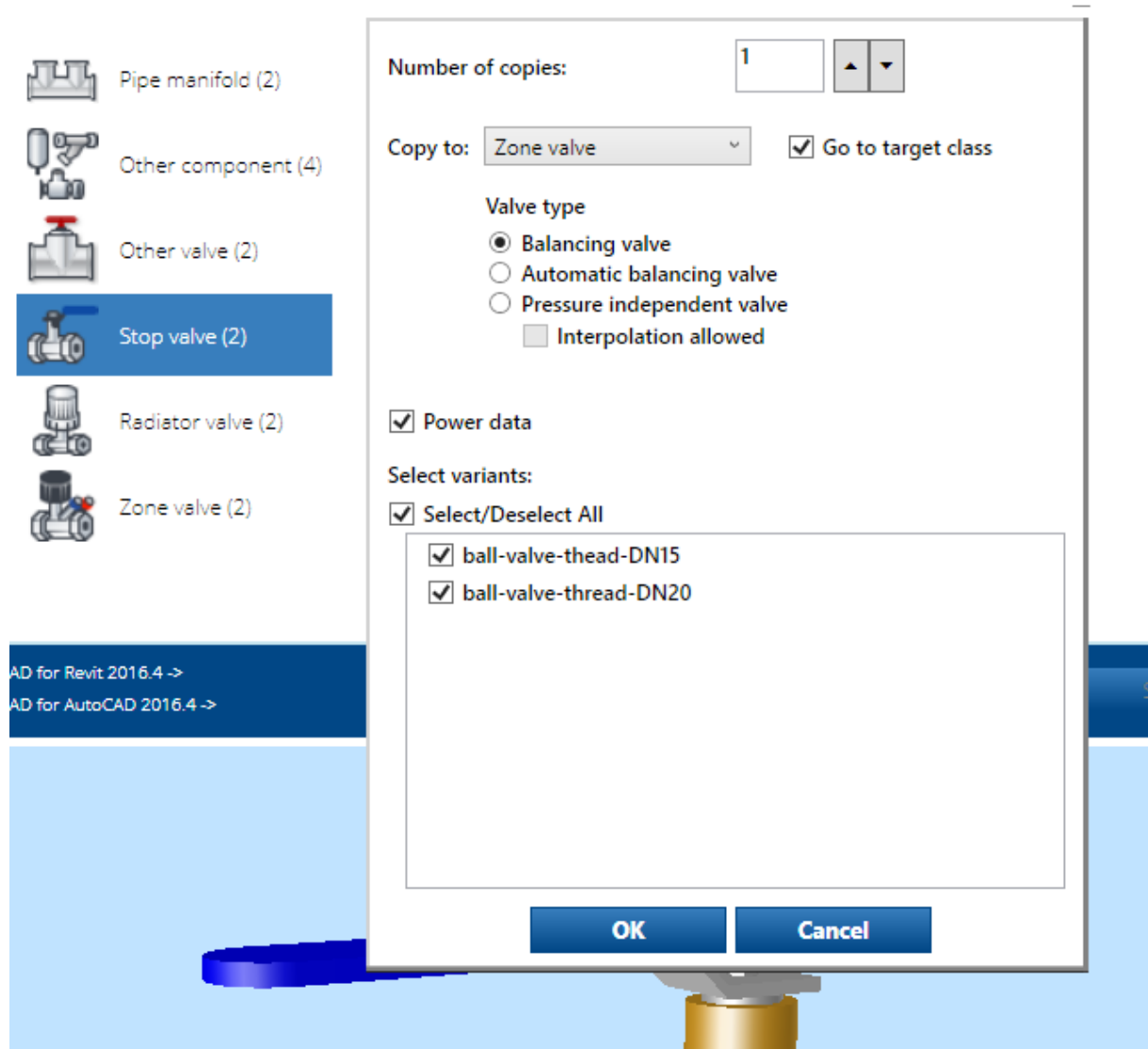

Power tab has been added to several product types

The power tab can be found now also in **Stop valve, Radiator valve, Zone valve, Other valve, Domestic Water device, Other Component, Gas device, Gas component, Manifold.**

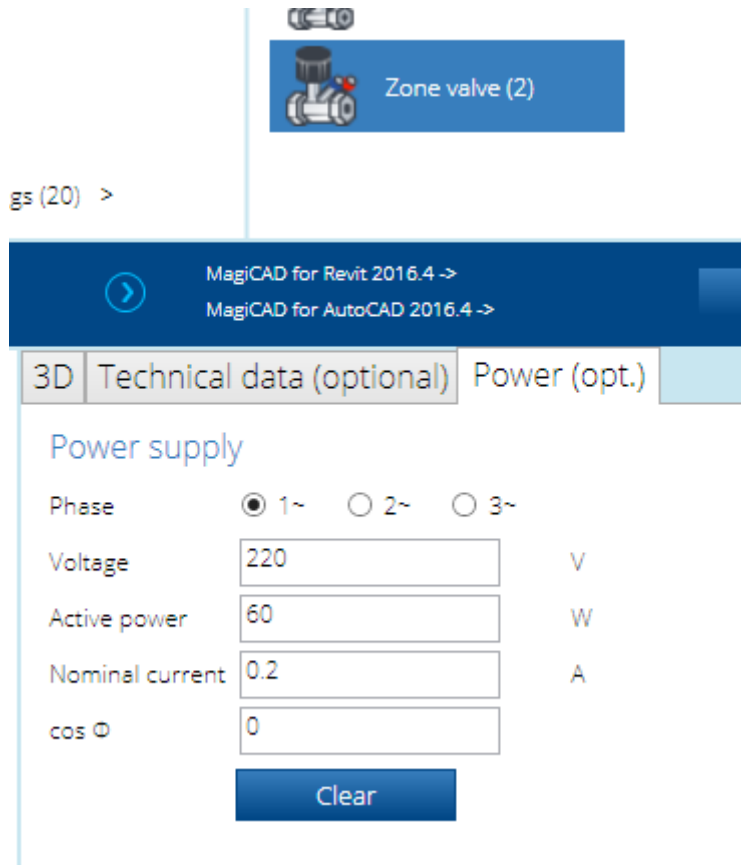

MagiCAD Create 2018.3 – Release notes

New features

Luminous flux

In this release, **Luminous flux** has been added to the **Luminaire** product type:

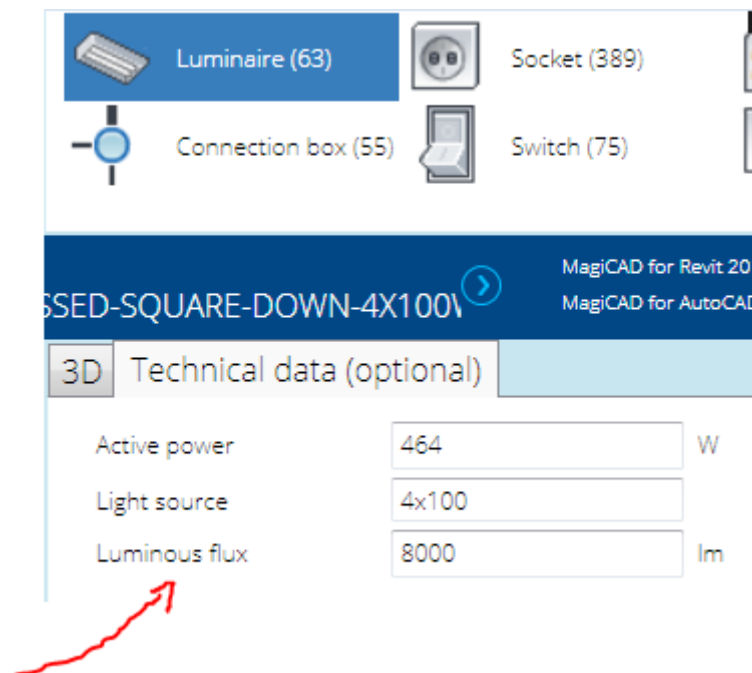

Support for Air Terminal Devices with more than 1 duct connections

The amount of duct connections can be changed:

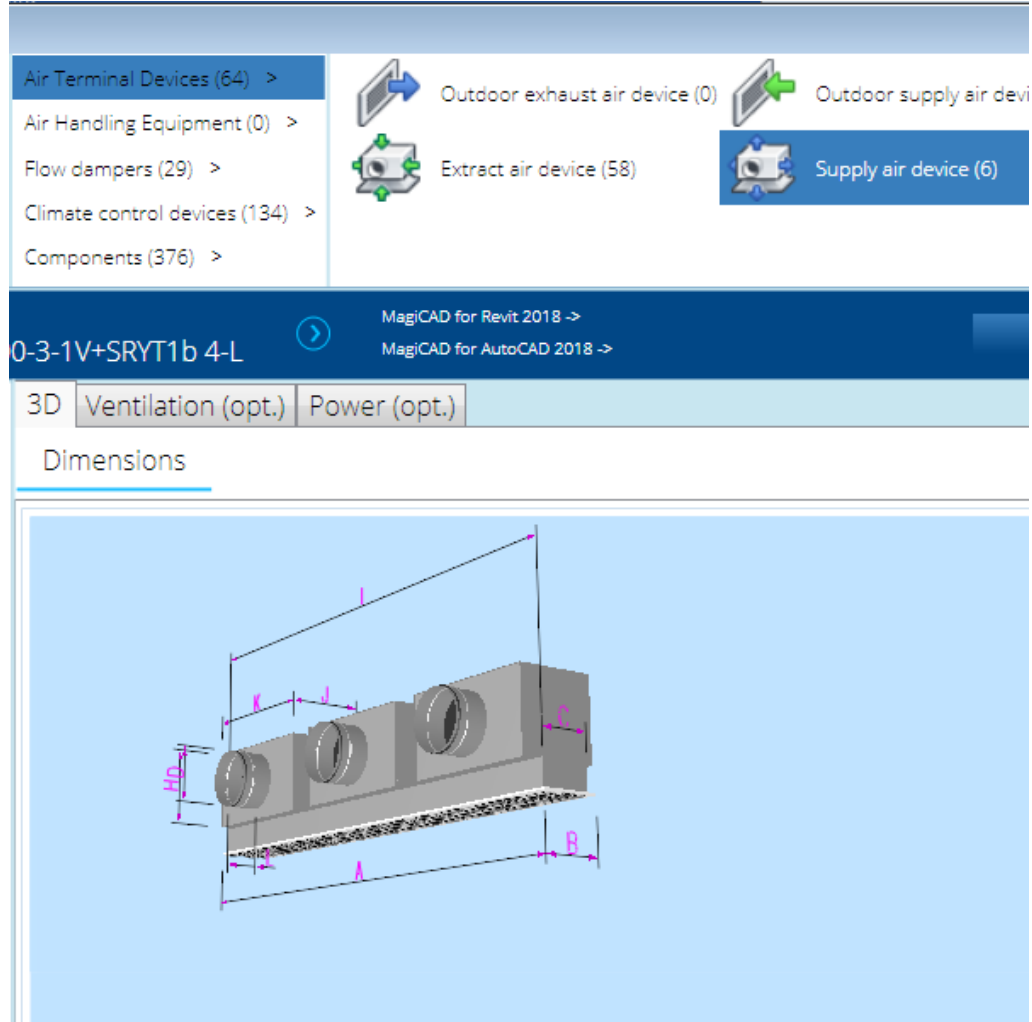

0-3-1V+SRYT1b 4-L

3D Ventilation (opt.) Power (opt.)

Dimensions

Dimensions [mm] and parameters

Description	Label	Value
Diffuser length	A	1797
Diffuser width	B	200
Duct diameter	D	200
	H	276
	J	270
	L	115
distance between conn.box	M	600
distance to 1 box	N	280
number of boxes	NB	3

Support for Climate beam with more than 1 duct connections

The amount of duct connections can be changed:

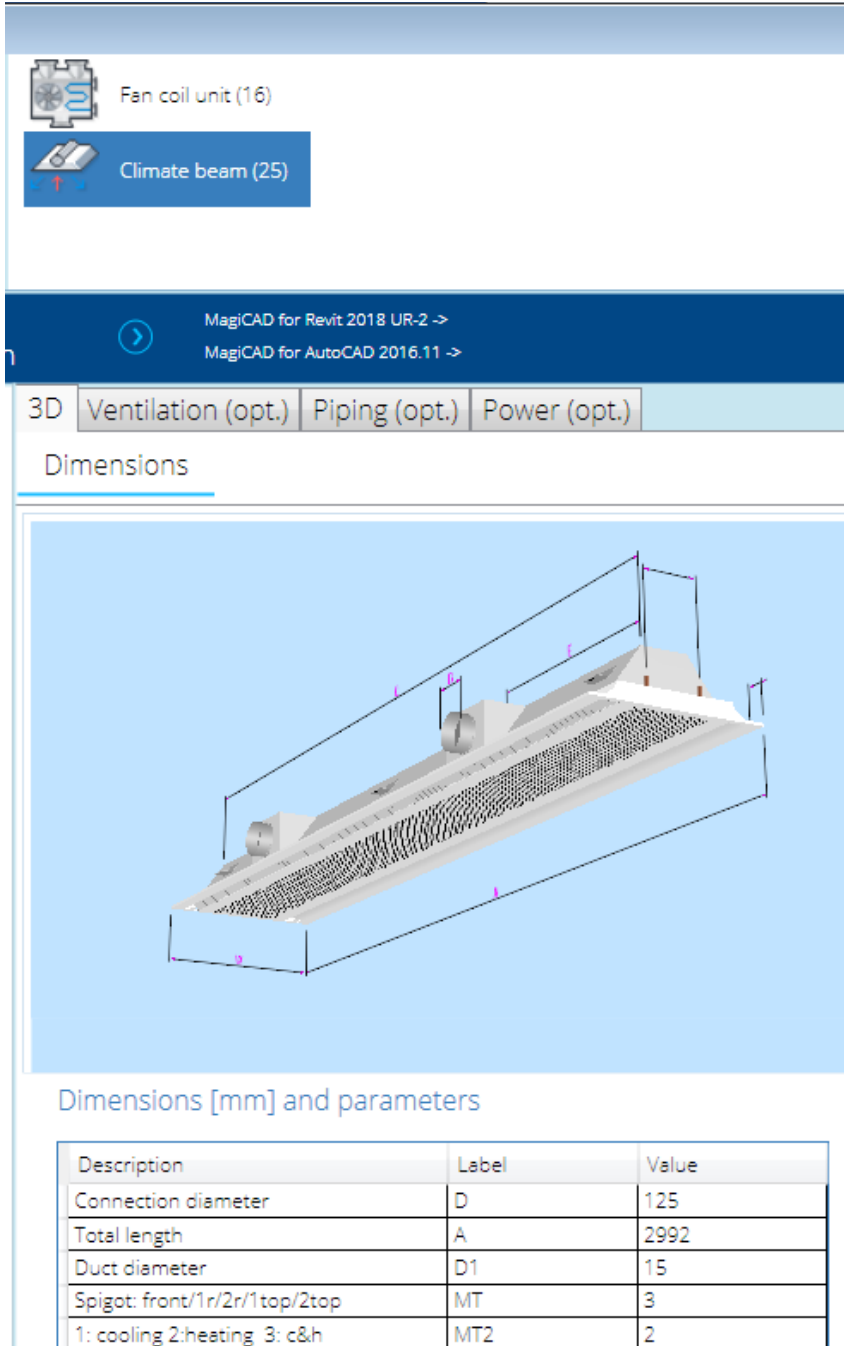

The screenshot shows the MagiCAD software interface. The ribbon is set to '3D' and 'Ventilation (opt.)'. The 'Climate beam (25)' tool is selected. Below the ribbon, the 'Dimensions' section is active, showing a 3D model of a climate beam with dimensions. Below the 3D model, the 'Dimensions [mm] and parameters' table is displayed.

Description	Label	Value
Connection diameter	D	125
Total length	A	2992
Duct diameter	D1	15
Spigot: front/1r/2r/1top/2top	MT	3
1: cooling 2:heating 3: c&h	MT2	2

MagiCAD Create 2017.12 – Release notes

New features

Modelling of Access panel

The modelling of Access panel has been added in this release.

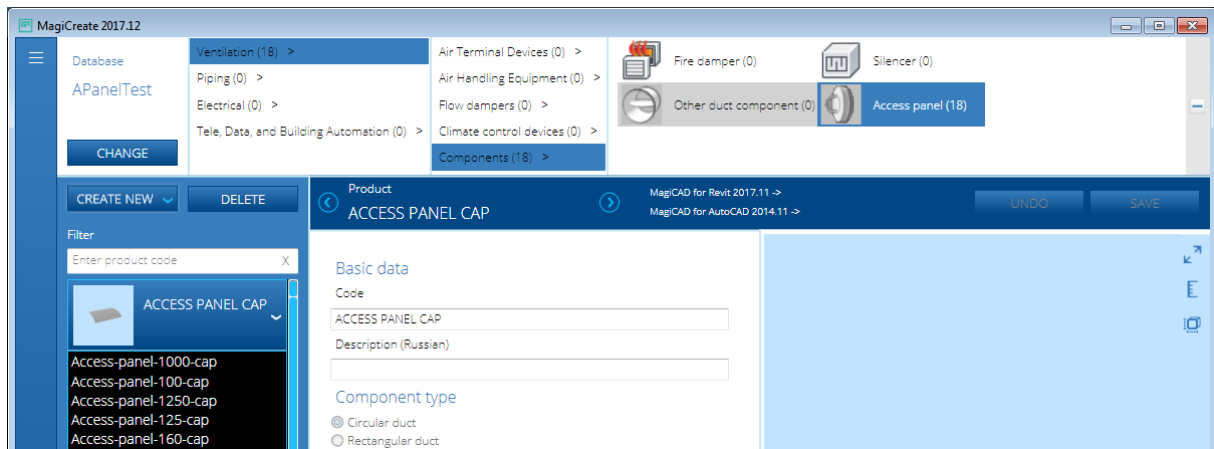

The 'Export products to spreadsheet' feature extended

Basic technical data can be exported from all **Piping** products.

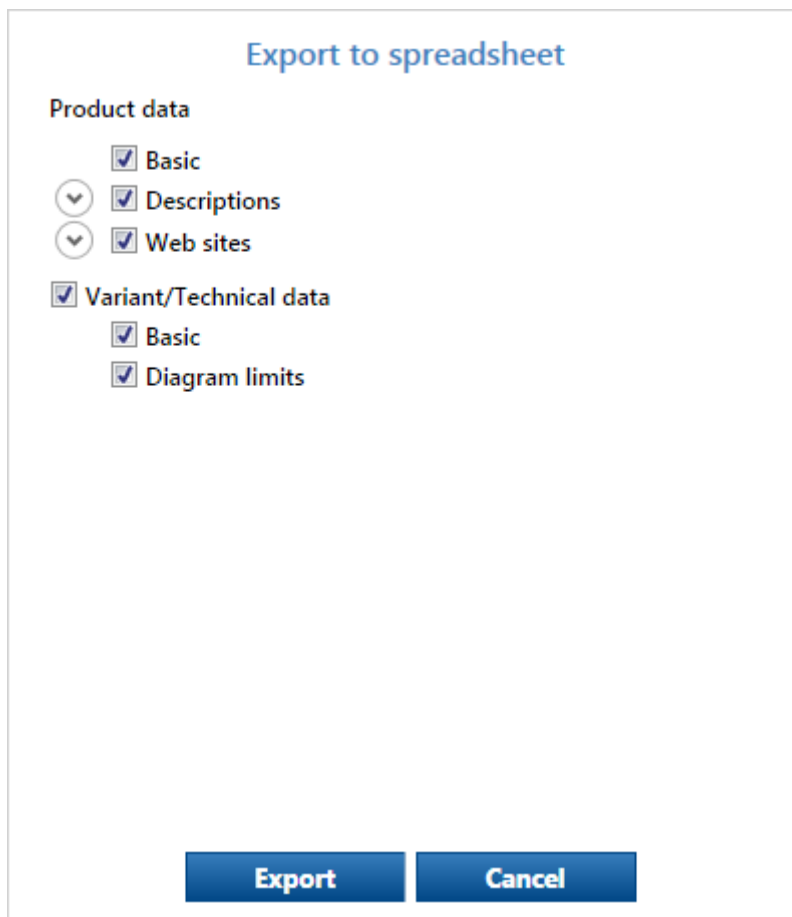
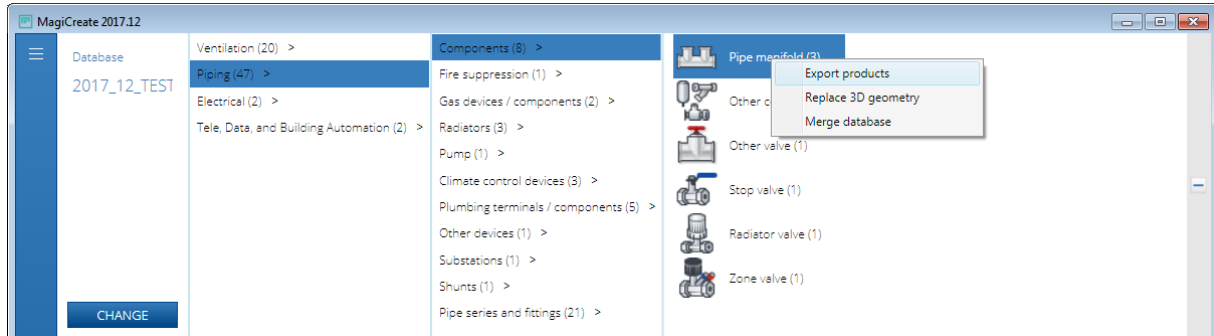

Export Database groups to spreadsheet

The database groups can be exported to spreadsheet, and the localized group headers can be edited there and imported back to the database.

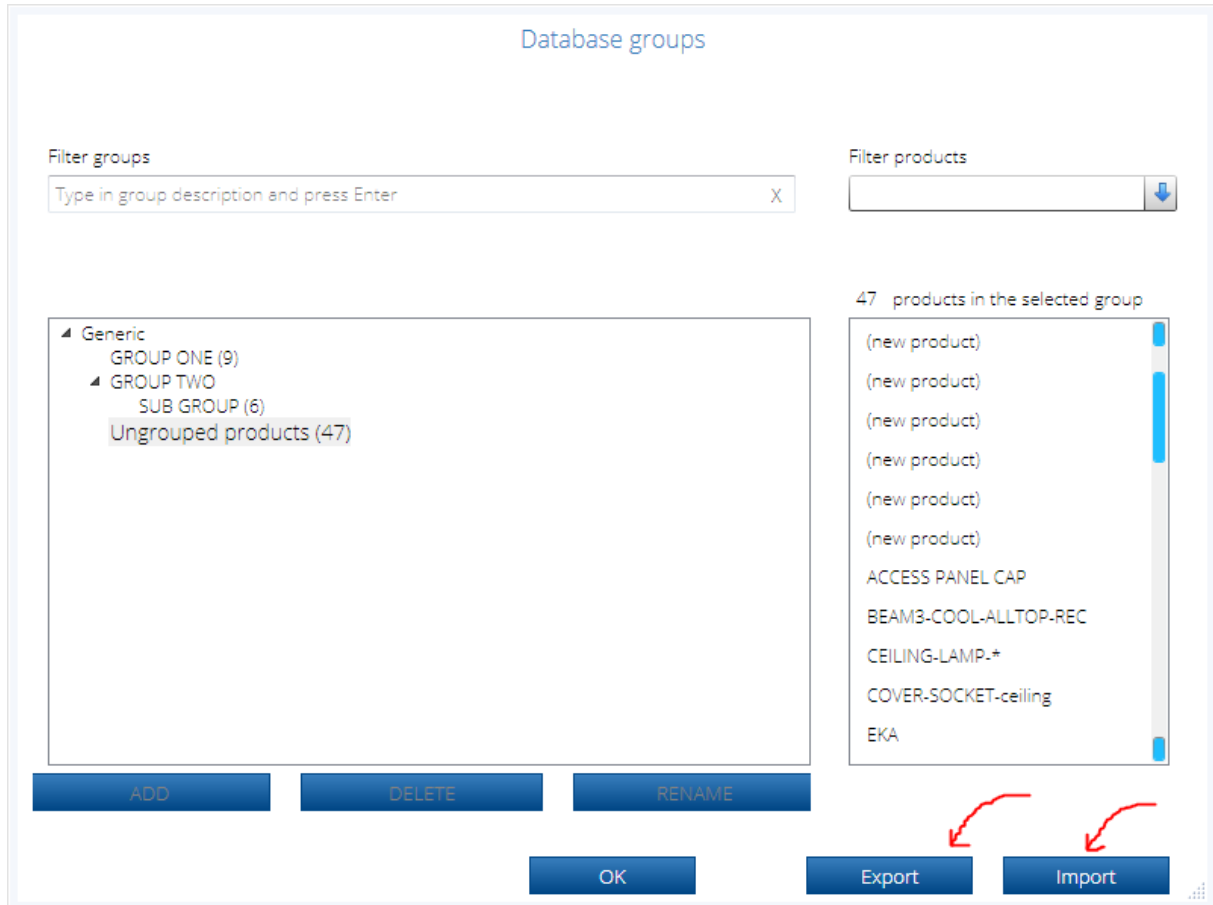

MagiCAD Create 2017.10 – Release notes

New features

‘Export products to spreadsheet’ feature extended

The technical data can be exported from all **Electrical** products as well as all products from **Tele, Data, and Building Automation**.

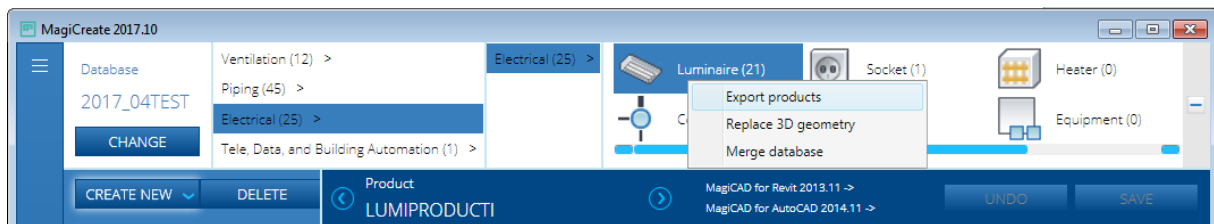

Extended Descriptions and Market area codes and websites

The amount of description languages has been added, as well as the possible Market areas:

Descriptions

Language	Description
Chinese	排气罩, 矩形连接
Swedish	Swedish desc
Russian	Russian desc
French	French desc
English	Exhaust air cowl, rectangular connection
English(US)	English description
Arabic	
Bosnian	
Bulgarian	
Croatian	
Czech	
Danish	
Dutch	
Estonian	
Finnish	
Flemish	
German	
Hungarian	
Icelandic	
Italian	
Japanese	

OK
Cancel

Market area codes and websites

Market area	Website	Code	Available
Russia	www.r.com	market area code for russian markets	<input type="checkbox"/>
Great Britain	www.gb.com	market area code for GB markets	<input type="checkbox"/>
Bosnia and Herzegovina			<input type="checkbox"/>
Bulgaria			<input type="checkbox"/>
China			<input type="checkbox"/>
Croatia			<input type="checkbox"/>
Czech Republic			<input type="checkbox"/>
Denmark			<input type="checkbox"/>
Estonia			<input type="checkbox"/>
Finland			<input type="checkbox"/>
France			<input type="checkbox"/>
Germany			<input type="checkbox"/>
Hungary			<input type="checkbox"/>
Iceland			<input type="checkbox"/>
Italy			<input type="checkbox"/>
Japan			<input type="checkbox"/>
Latvia			<input type="checkbox"/>
Lithuania			<input type="checkbox"/>
Norway			<input type="checkbox"/>
Poland			<input type="checkbox"/>
Portugal			<input type="checkbox"/>

OK
Cancel

Improved modelling of the Air Terminal Devices

The modelling of the **Air Terminal Devices** can now be started by defining the size range of the variants. The common technical data can be given for all sizes. This is a significantly helpful tool for creating quickly hundreds of rectangular grilles. After entering the data, the distinct variants can be created by pressing the **CREATE** button.

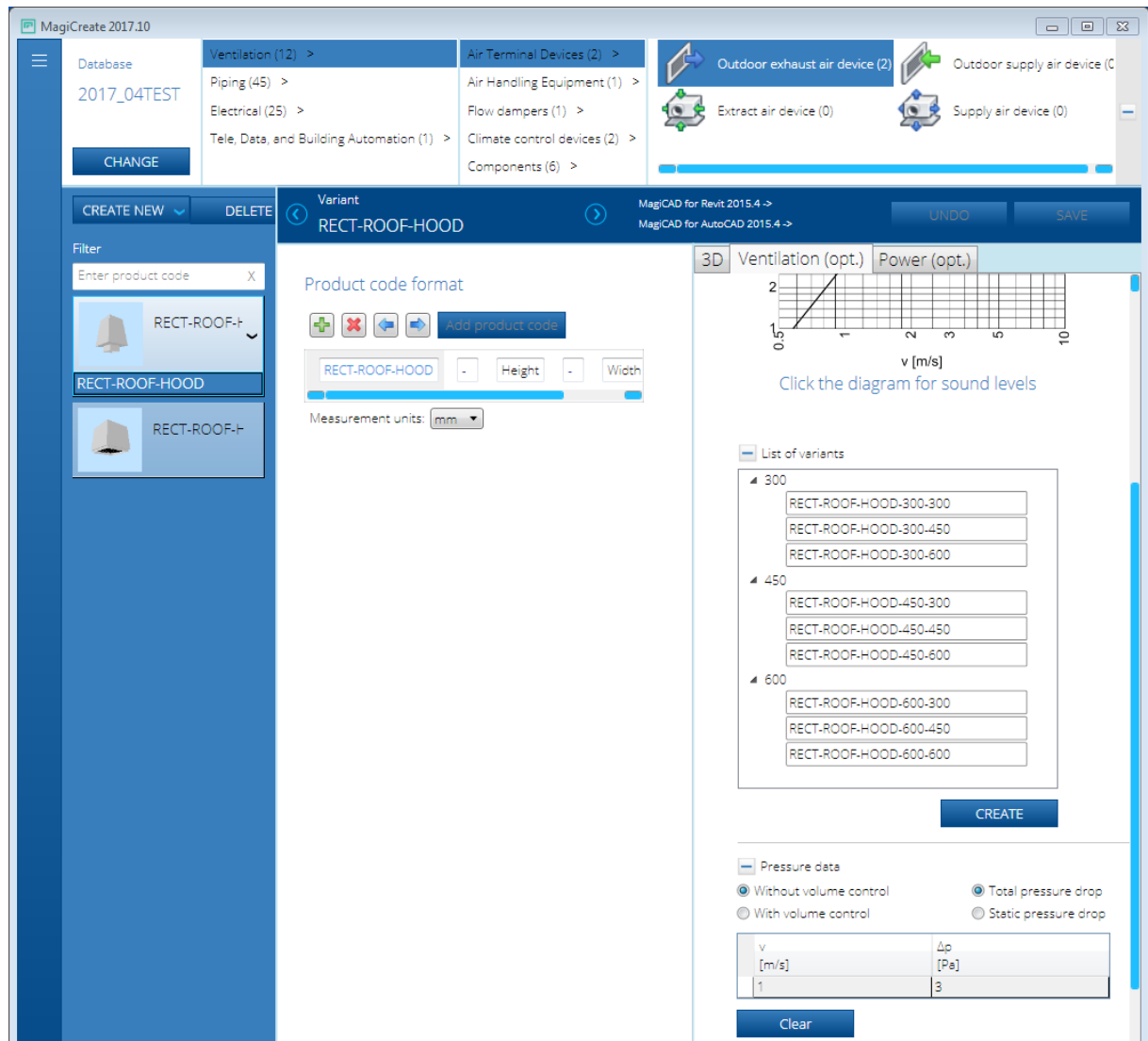

Manufacturer article number

In this release, **Manufacturer article number** has been added to every product type:

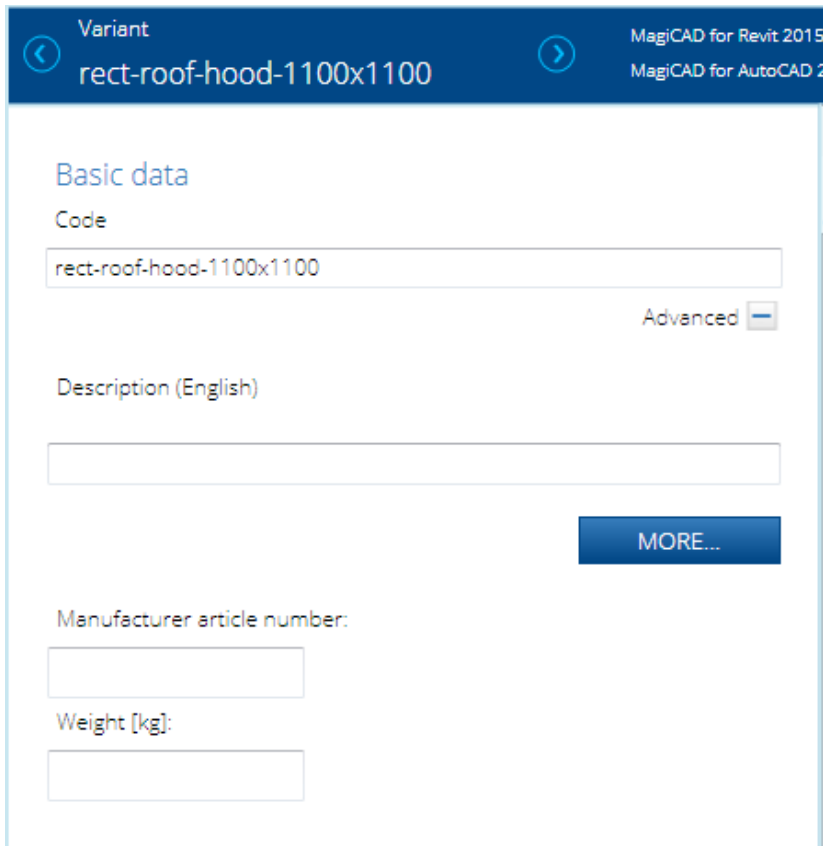

The screenshot displays the 'Basic data' section of a product variant in the MagiCAD software. The variant name is 'rect-roof-hood-1100x1100'. The 'Code' field contains the same text. The 'Description (English)' field is empty. A 'MORE...' button is visible. The 'Manufacturer article number' and 'Weight [kg]' fields are also empty.

Variant
rect-roof-hood-1100x1100

MagiCAD for Revit 2015
MagiCAD for AutoCAD 2015

Basic data

Code
rect-roof-hood-1100x1100

Advanced

Description (English)

MORE...

Manufacturer article number:

Weight [kg]:

MagiCAD Create 2017.6 – Release notes

New features

Database groups

In this release, database groups can be created and modified. The **Database groups** dialog can be started in the main menu:

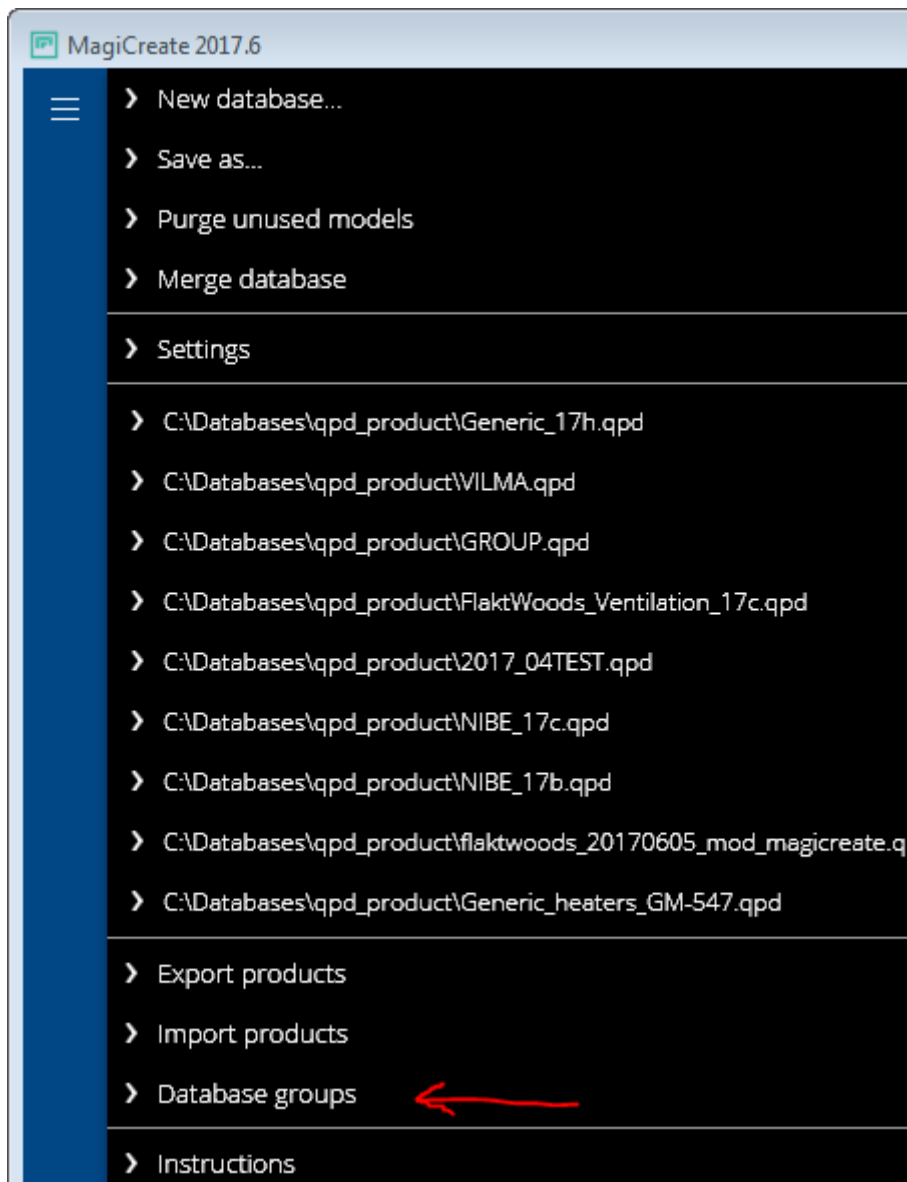

In the **Database groups** dialog, the groups can be added, deleted and renamed. The location in the group tree can be changed by dragging the group and dropping it in the new location. If the group is removed, the products in the group will be moved to the **Undefined** group.

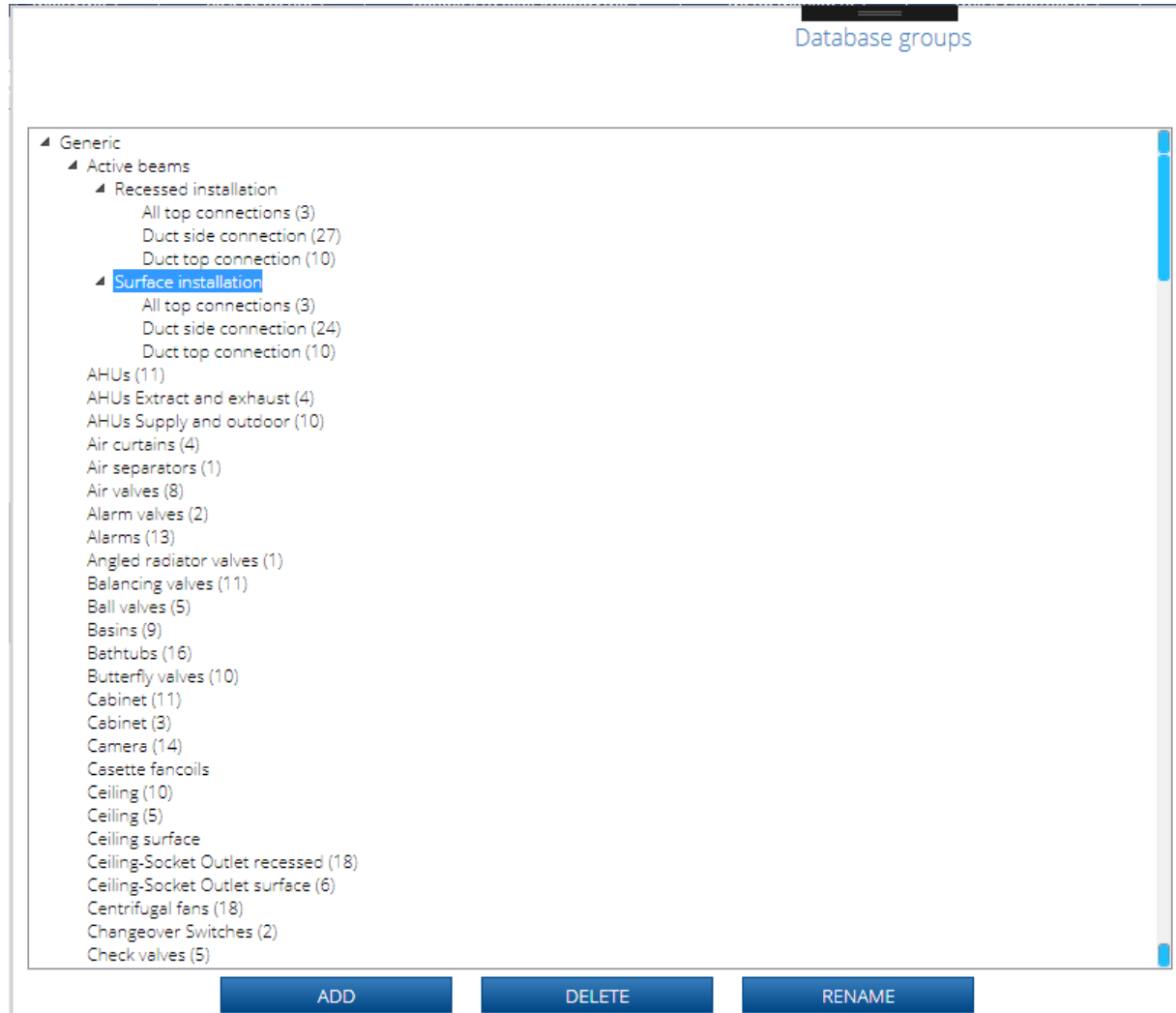

The selected products listed on the right can be dragged and dropped to any leaf (= lowest level) group.

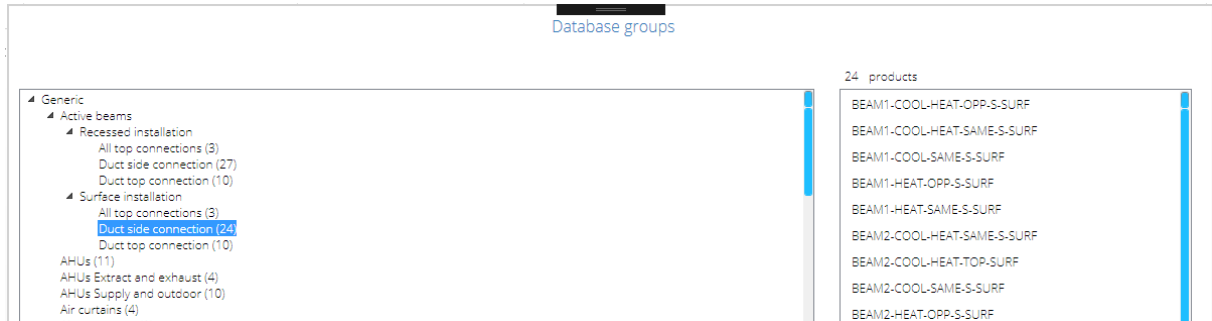

When starting **Database groups** in a new database, all existing products will automatically be connected to the **Undefined** group.

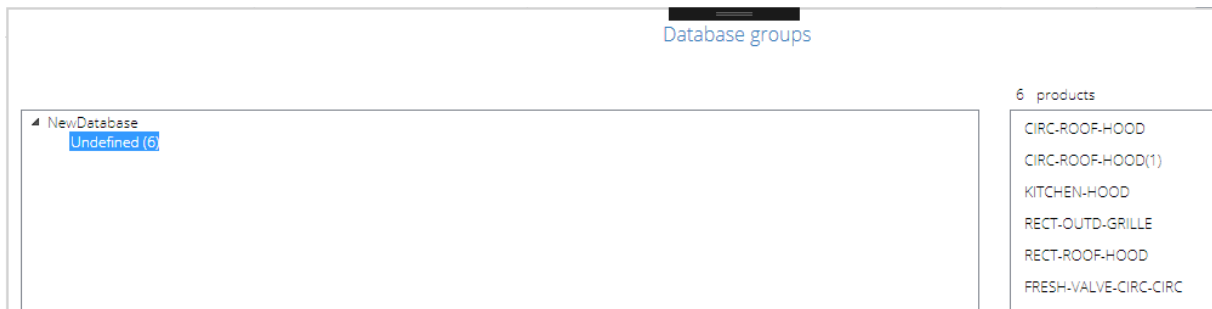

Manufacturer name abbreviation

The **Manufacturer name abbreviation** field is a new three letter field in the **Settings**:

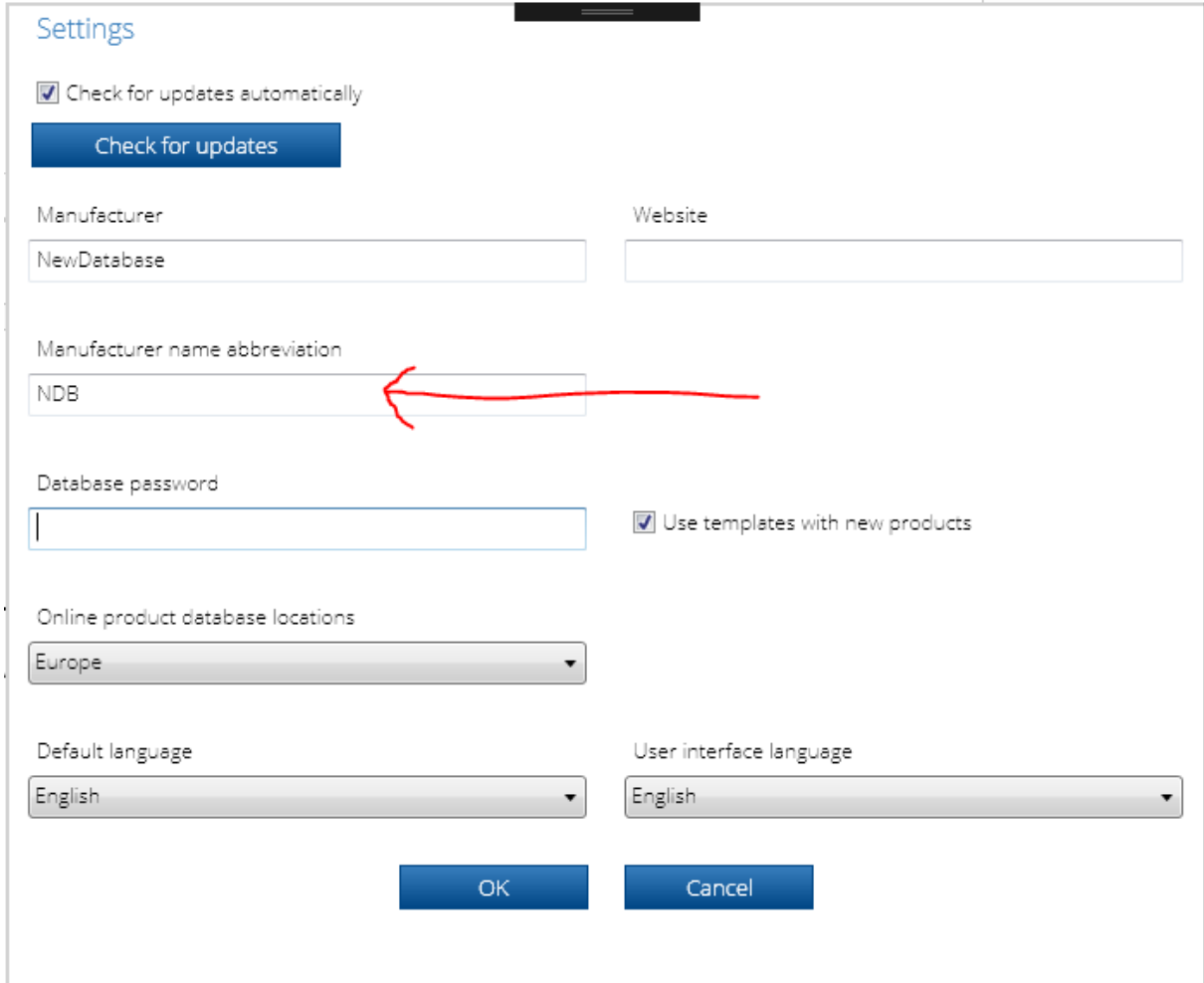

The screenshot shows the 'Settings' dialog box with the following fields and options:

- Check for updates automatically
- Check for updates (button)
- Manufacturer: NewDatabase
- Website: (empty)
- Manufacturer name abbreviation: NDB (highlighted with a red arrow)
- Database password: (empty)
- Use templates with new products
- Online product database locations: Europe
- Default language: English
- User interface language: English
- Buttons: OK, Cancel

The **Manufacturer name abbreviation** value in this field will be saved for every product in the database. It is not visible in MagiCAD Create.

The **3D** tab has been divided into two sub tabs.

Dimensions:

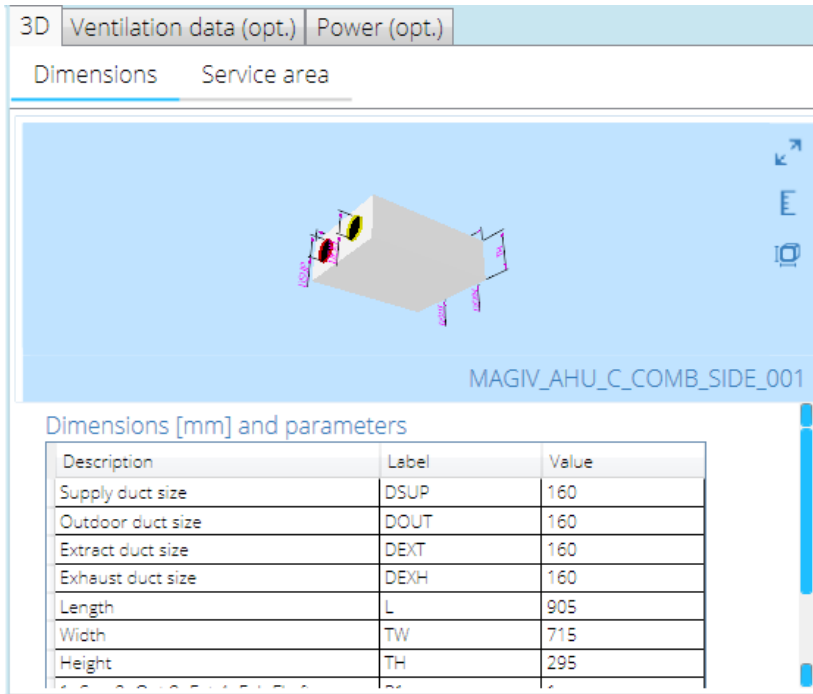

3D Ventilation data (opt.) Power (opt.)

Dimensions Service area

MAGIV_AHU_C_COMB_SIDE_001

Dimensions [mm] and parameters

Description	Label	Value
Supply duct size	DSUP	160
Outdoor duct size	DOUT	160
Extract duct size	DEXT	160
Exhaust duct size	DEXH	160
Length	L	905
Width	TW	715
Height	TH	295

Service area:

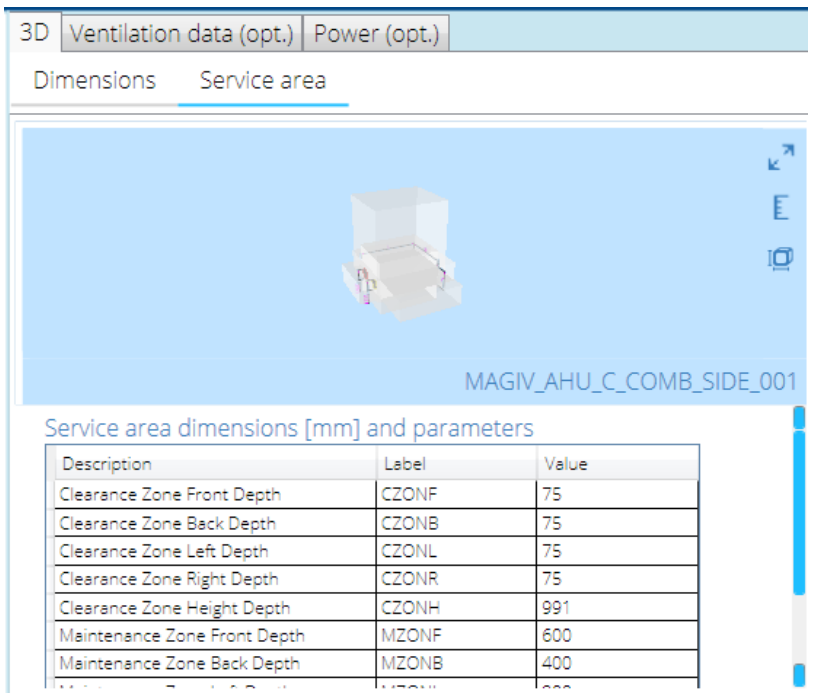

3D Ventilation data (opt.) Power (opt.)

Dimensions Service area

MAGIV_AHU_C_COMB_SIDE_001

Service area dimensions [mm] and parameters

Description	Label	Value
Clearance Zone Front Depth	CZONF	75
Clearance Zone Back Depth	CZONB	75
Clearance Zone Left Depth	CZONL	75
Clearance Zone Right Depth	CZONR	75
Clearance Zone Height Depth	CZONH	991
Maintenance Zone Front Depth	MZONF	600
Maintenance Zone Back Depth	MZONB	400

The **Service area** sub tab only exists with parameters starting with “**CZ**” or “**MZ**” in the 3D Geometry.

MagiCAD Create 2017.4 – Release notes

New features

‘Export products to spreadsheet’ feature extended

In this release, the technical data can be exported from all Ventilation products, also from Fans / Air handling units, Fan coils, and Climate beams.

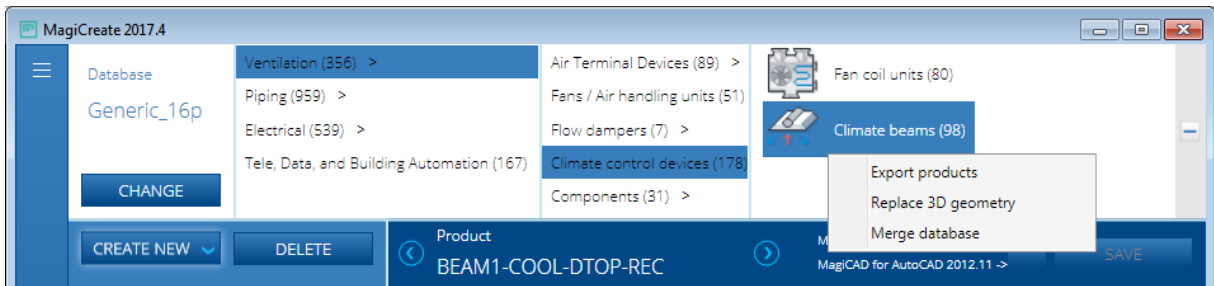

Modelling of Pipe series and fittings

The modelling of Pipe series and fittings is also possible in this release.

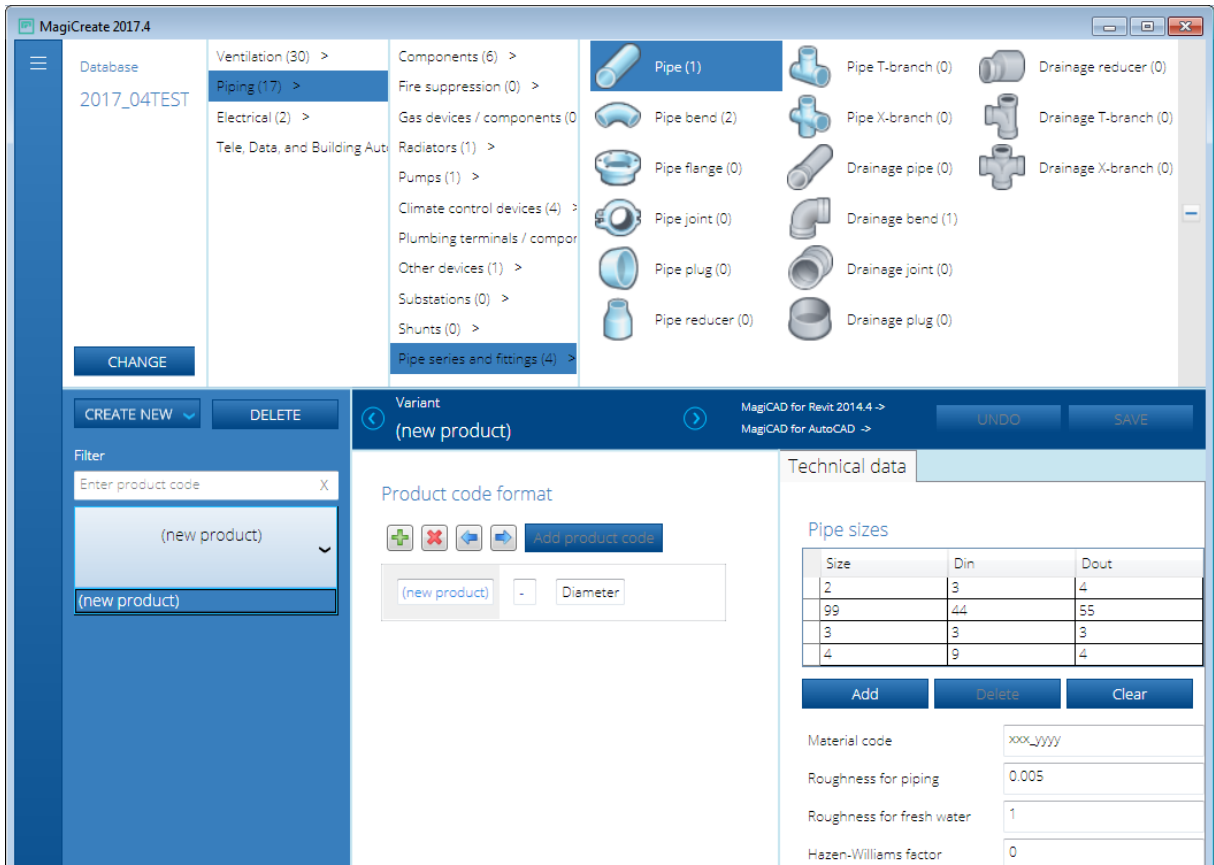

Modelling of Combination boxes

The modelling of Combination boxes has been added in this release.

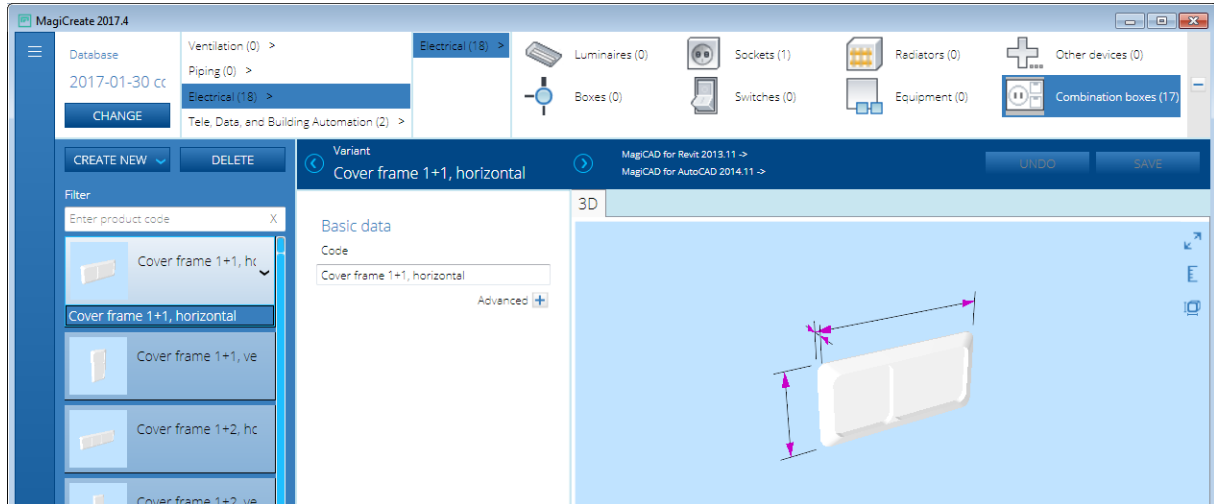

Product count is visible in all product categories

The number of products in the product category can be seen in parenthesis at the end of each category name.

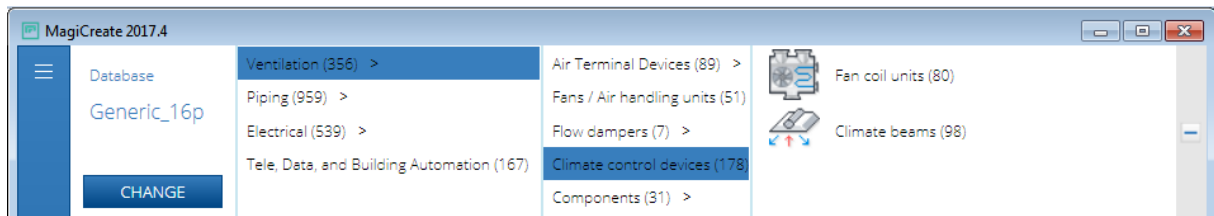

MagiCAD Create 2017.1 – Release notes

New features

‘Export products to spreadsheet’ feature extended

When exporting the selected product class or selected products, also technical data can be exported to a spreadsheet. In this release, the technical data can be exported from Ventilation products (except Fan coils and Climate beams).

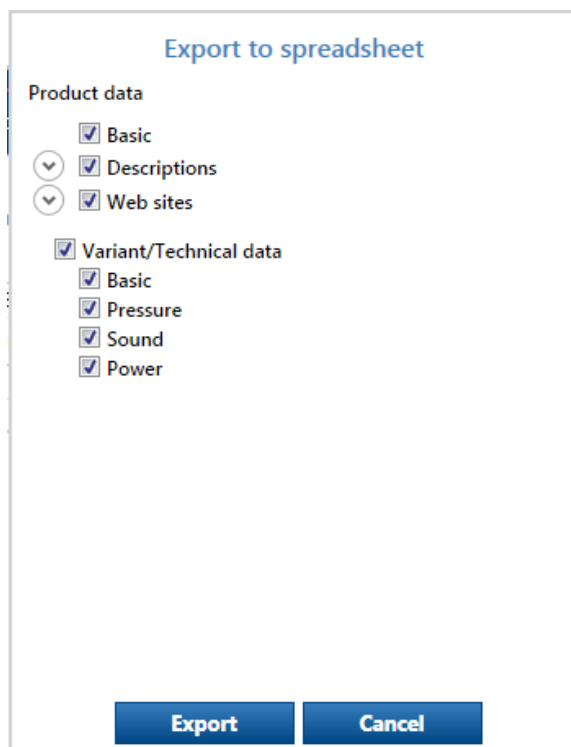
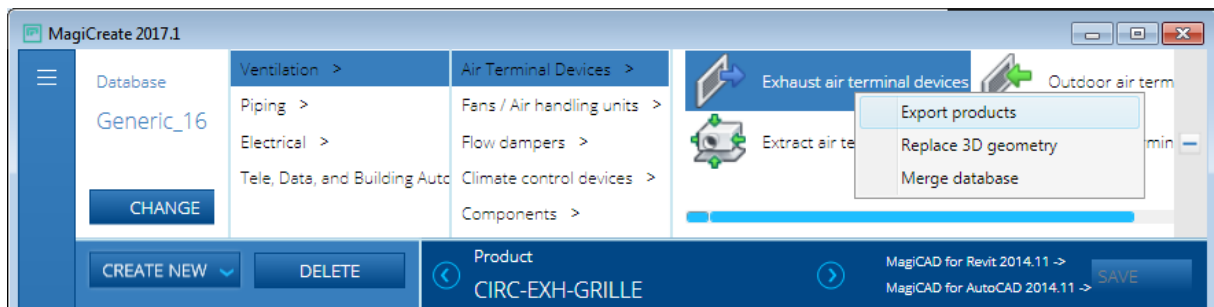

Merge database

The whole external database can now be merged with the current database. All products with 3D geometry can be merged.

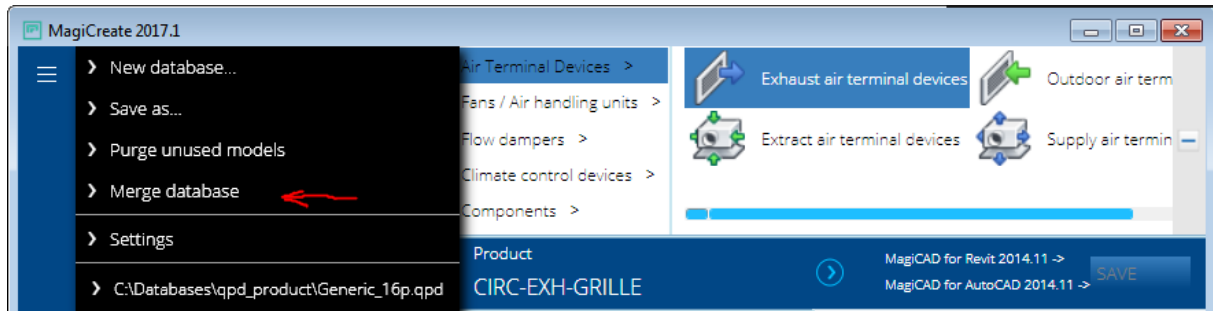

MagiCAD Create 2016.11 – Release notes

New features

Export products to spreadsheet

The whole database, selected product class or selected products can be exported to a spreadsheet. The export data can consist of **Basic** data (product code, country restrictions), **Descriptions** (short product descriptions of the selected languages) and **Web sites** (of the selected countries):

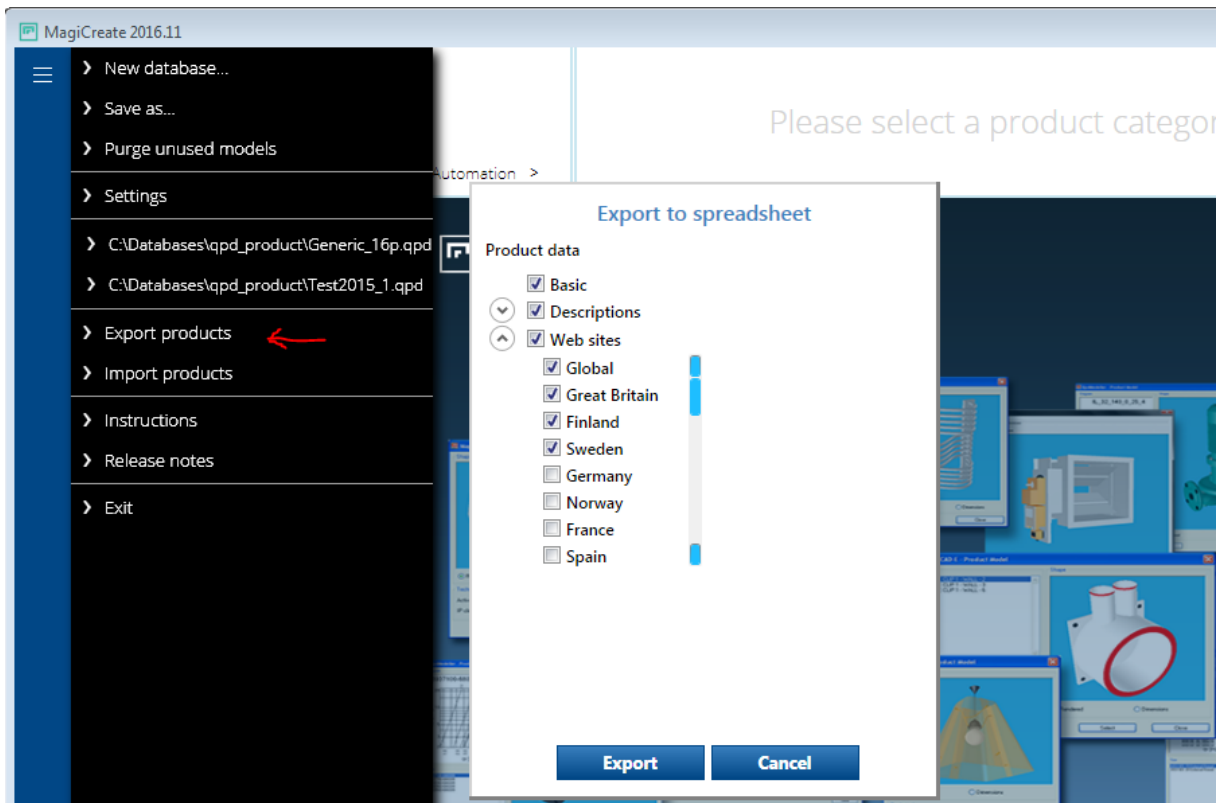

The data can be modified and supplied in the spreadsheet:

	A	B	C	D	E	F	G	H
1	MagiCAD product type	Product code	3D geometry	Restricted to countries		Short product description. Max. 60 characters.		
2						English (mandatory)	German	French
3	Exhaust air terminal devices	CIRC-EXH-GRILLE	MAGIV_CIRC-OUTD-	China,Denmark,Finland,Germany,Great	Change	Weather protection grille, circular	German description ...	French description
4	Exhaust air terminal devices	CIRC-ROOF-HOOD	MAGIV_CIRC-ROOF_		Change	Exhaust air cowl, circular		
5	Exhaust air terminal devices	EXT-WALL-GRILLE	MAGIV_EXT-WALL-	Estonia,Finland,France	Change	External wall grille for exhaust		
6	Exhaust air terminal devices	RECT-EXH-GRILLE	MAGIV_RECT_EXH_G		Change	Weather protection grille,		
7	Exhaust air terminal devices	RECT-EXH-GRILLE-CIRC	MAGIV_RECT_GRIL_C		Change	Weather protection grille for circular		

Import products from spreadsheet

After having input the data to the spreadsheet, it can be imported back to the database:

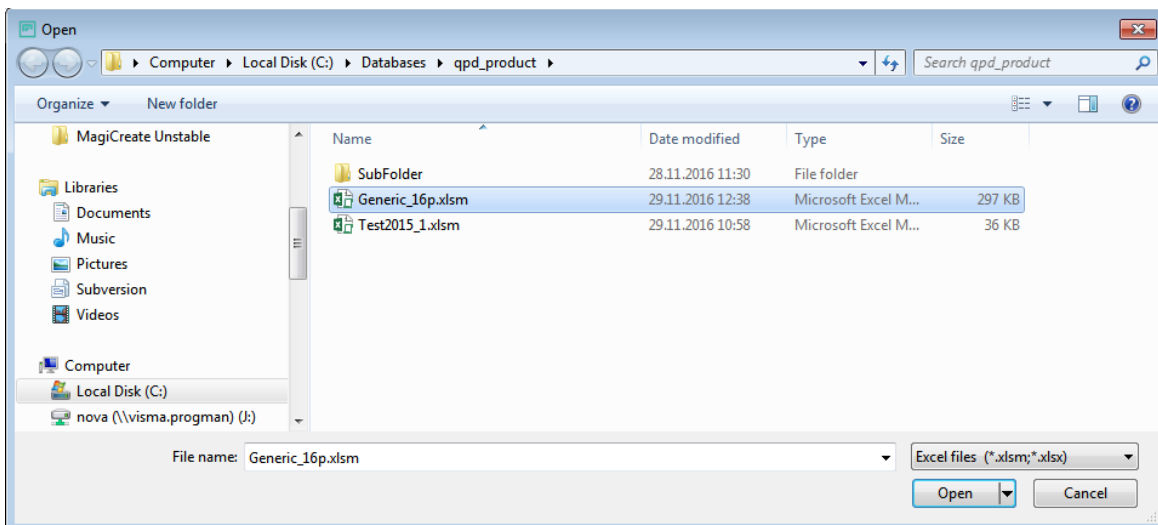
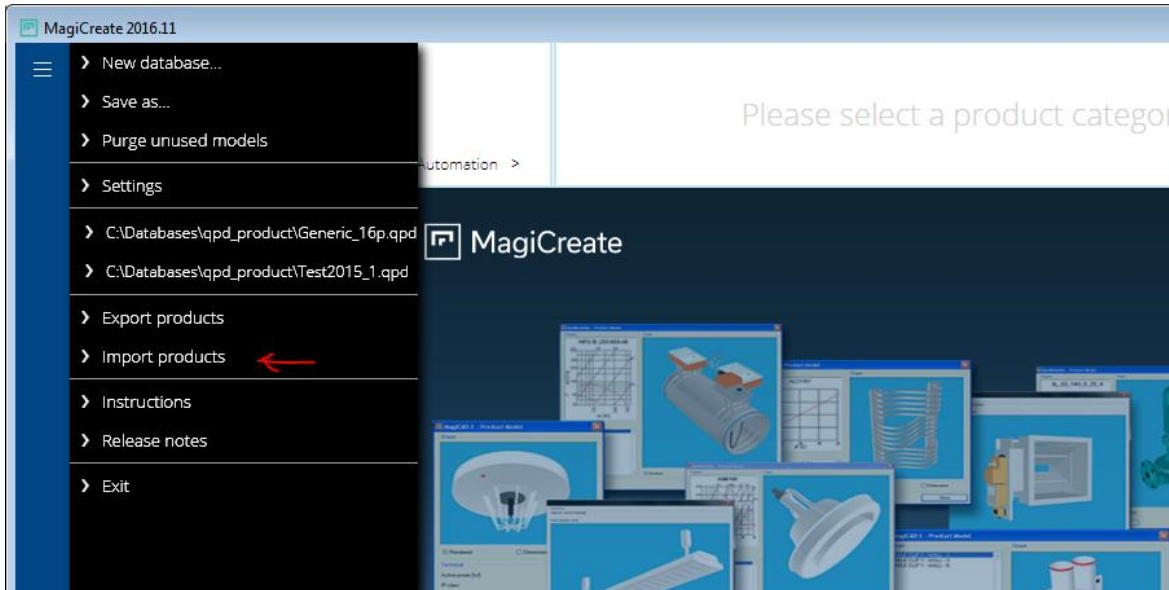

Finally, a report of the modifications is shown and the changes will be applied on accept:

Import report

Database: Generic_16p

Product code and type	Attribute name	Values
CIRC-EXH-GRILLE Exhaust air terminal devices	French description	Current: New: French description
	Restricted to countries	Current: New: China,Denmark,Finland,Germany,Great Britain
EXT-WALL-GRILLE Exhaust air terminal devices	Restricted to countries	Current: New: Estonia,Finland,France

Accept Discard

Replace 3D geometry

It is now possible to replace the products' 3D geometry. The **Replace 3D geometry** function can be found in the context menu of the selected product class:

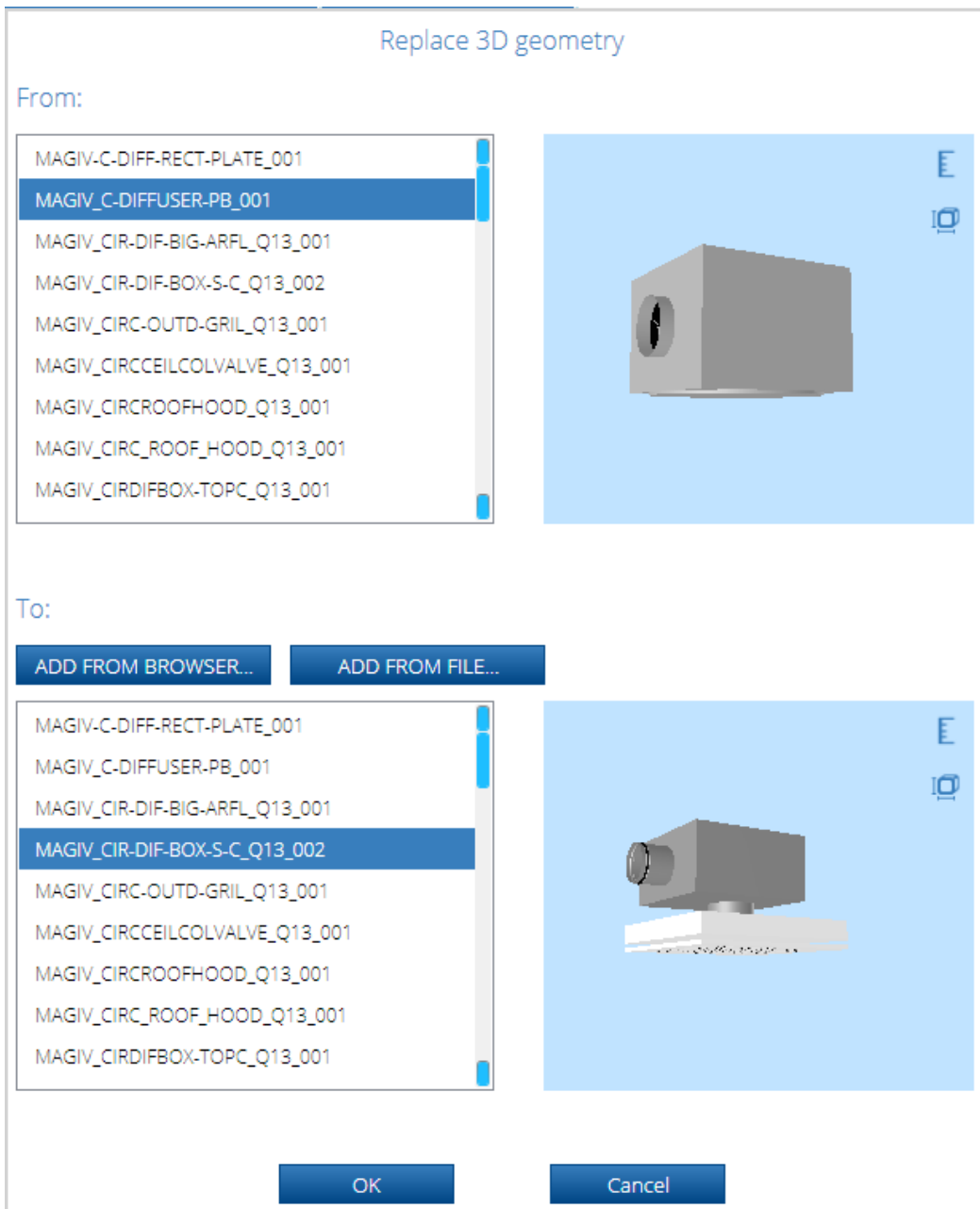
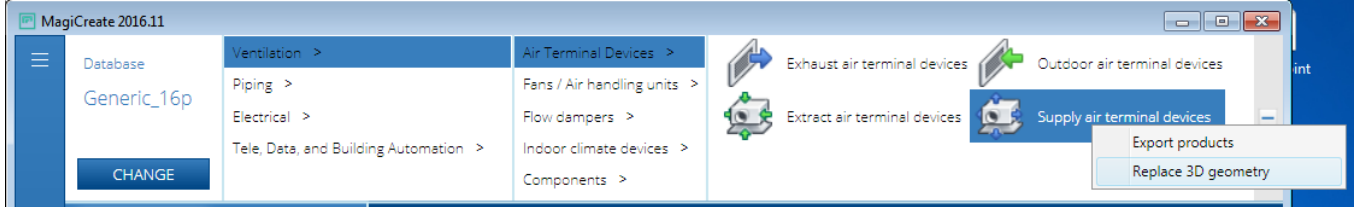

The 3D geometry to be replaced (**From:**) and the replaced 3D geometry (**To:**) are shown at the top. All products using the original 3D geometry are selected by default.

Replace 3D geometry

From: MAGIV_C-DIFFUSER-PB_001

To: MAGIV_CIR-DIF-BOX-S-C_Q13_002

Remove unused 3D geometry

Select/Deselect All

- ▲ Extract air terminal devices
 - Select/Deselect All
 - RECT-DIFF-BOX-SIDE
- ▲ Supply air terminal devices
 - Select/Deselect All
 - CEIL-DIFF-PB-S
 - CEIL-DIFF-PB-T
 - RECT-DIFF-BOX-SIDE

4 products selected

OKCancelCopy to clipboard

If all products are selected, the unused 3D geometry can be removed by checking the **Remove unused 3D geometry** checkbox.