



# **TTM MagiCAD Plugin**

User guide

26/05/2023

## Content

<b>GENERAL</b> .....	<b>3</b>
About this document .....	3
Installing the software .....	3
Required third-party software .....	3
Before installation .....	3
Installation .....	3
Starting the program .....	4
<b>FUNCTIONS</b> .....	<b>5</b>
TTM MagiCAD plugin UI overview .....	5
Insert operation .....	5
Copy operation .....	5
Update operation .....	5
Recalculate operation .....	5
View technical data operation .....	5
Detailed insert operation .....	6
Detailed copy operation .....	11
Detailed update operation .....	13
Detailed recalculate operation .....	17
Detailed view technical data operation .....	21

## General

### About this document

This document contains instructions on using TTM MagiCAD plugin.

TTM MagiCAD plugin allows user to insert, copy, update, recalculate and view the technical data of the shunt units with MagiCAD.

### Installing the software

#### Required third-party software

TTM MagiCAD plugin works with the following MagiCAD and AutoCAD versions

- MagiCAD 2023 and AutoCAD 2019-2023
- MagiCAD 2024 and AutoCAD 2021-2024

#### Before installation

1. Workstation administrator privileges are recommended for installation.
2. **Notice if you have several AutoCAD versions on your workstation.** Before you run the plugin installer, start MagiCAD to make sure that TTM MagiCAD Plugin installs on the same AutoCAD platform as MagiCAD.

#### Installation

1. Download the installer file from MagiCAD portal to your workstation:  
  
<https://portal.magicad.com/Download/ProductSearch?searchStr=TTM&categoryId=3>
2. Run the TTM MagiCAD plug-in installer on your workstation.

## Starting the program

The plugin is automatically loaded and is ready to be used once MagiCAD is started next time after the plugin is installed.

Before you start using the TTM MagiCAD plugin, (re)start the MagiCAD and open a Heating and piping project.

Locate the MagiCAD plugins tab from the AutoCAD ribbon. Once the TTM MagiCAD plugin is loaded its ribbon panel can be found from the MagiCAD plugins tab. When the drop-down button is clicked the list of available operations will be shown.

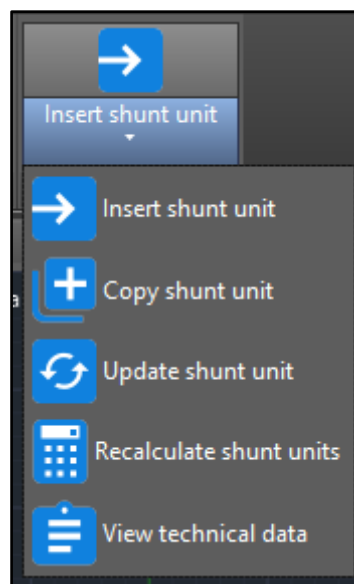

Figure 1 Plugin ribbon panel operations

## Functions

### TTM MagiCAD plugin UI overview

Plugin contains the following operations:

#### Insert operation

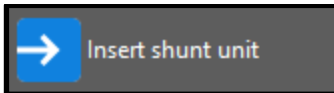

This command inserts a new shunt unit to MagiCAD with TTM calculation program software.

#### Copy operation

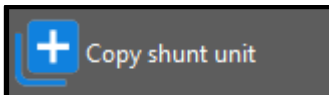

This command makes shunt unit inserting faster without going through the TTM calculation program.

#### Update operation

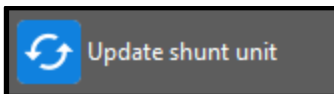

This command updates one shunt unit with the TTM calculation program and finally updates the data to shunt unit in MagiCAD.

#### Recalculate operation

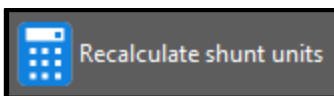

This command recalculates one or multiple shunt units with TTM calculation program and finally updates the data to shunt units in MagiCAD.

#### View technical data operation

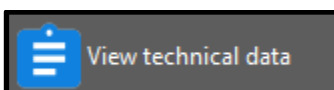

This command is for viewing the TTM calculation program generated technical data of the shunt unit in MagiCAD.

## Detailed insert operation

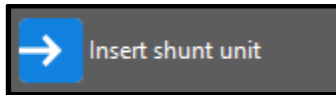

Follow these steps to insert TTM shunt unit to MagiCAD drawing:

1. Draw and balance the secondary circuit in MagiCAD. This is important because TTM MagiCAD plugin sends the secondary circuit flow and pressure drop data to the TTM calculation program. These values are input parameters for calculation program.
2. Click the “Insert shunt unit” button from TTM MagiCAD plugin ribbon panel or give the “TTM\_INSERT” command.
3. Once the operation is started, user is first prompted to select the MagiCAD system for the shunt primary circuit. The selected system will be set for the shunt unit that is exported to the MagiCAD via plugin.

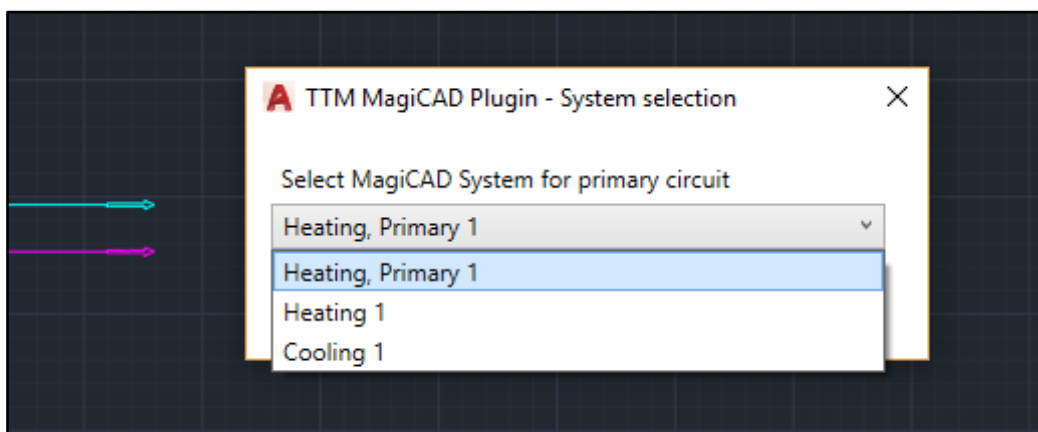

Figure 2 Selecting the primary circuit for the shunt unit

4. User is prompted to select the supply and return pipes of the secondary circuit. It is important to select that part (or near end) of the pipe that should be connected to the shunt unit. Reason for this is that plugin sends flow and pressure drop information data from the selected pipes to TTM calculation program.

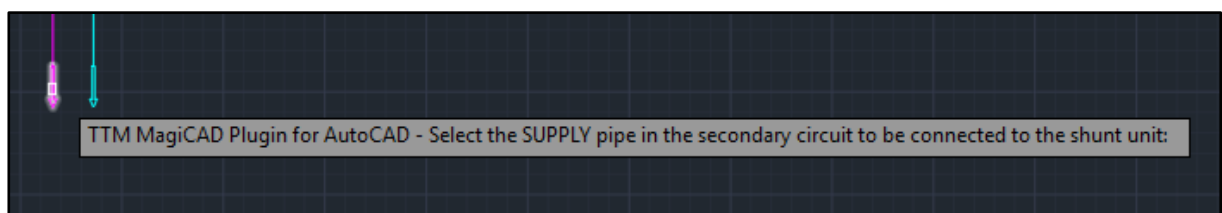

Figure 3 Selecting the supply pipe from the secondary circuit for the shunt unit

5. After secondary circuit pipe selections the TTM calculation program is started.

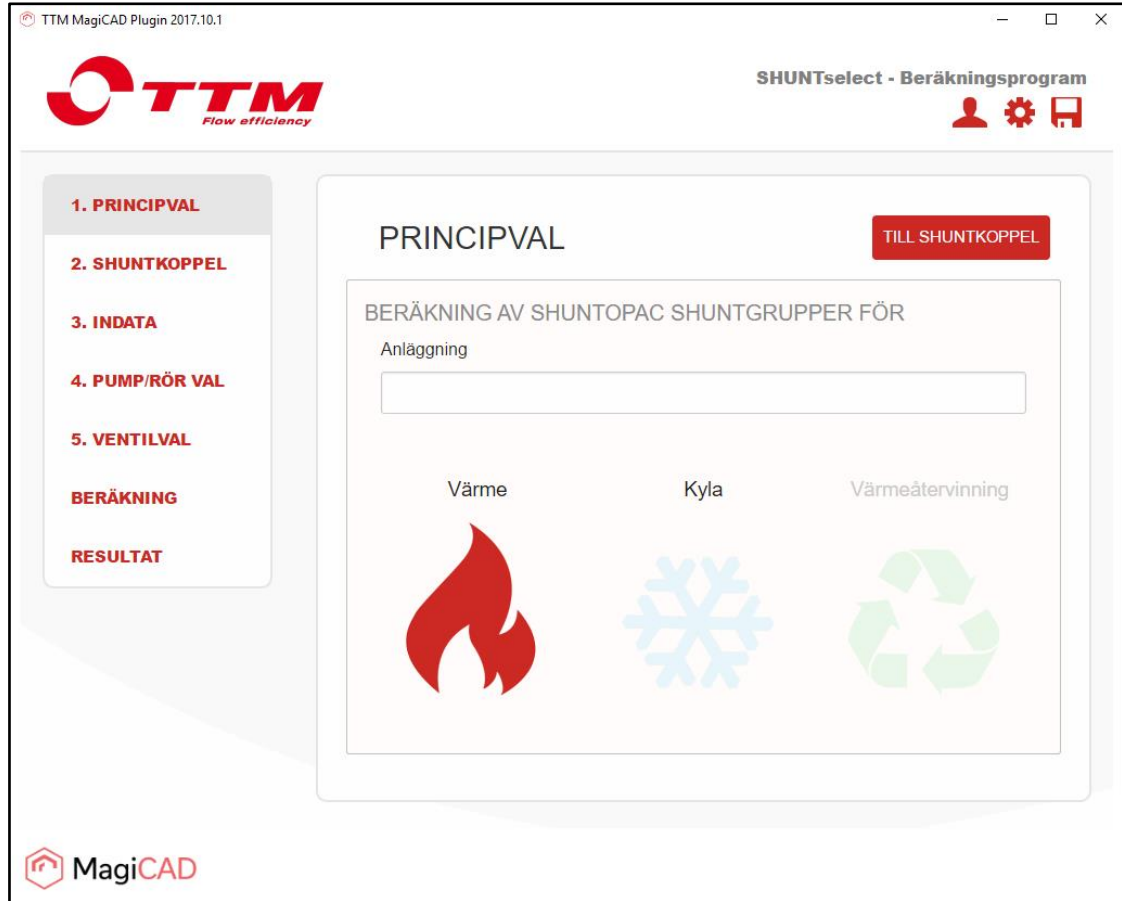
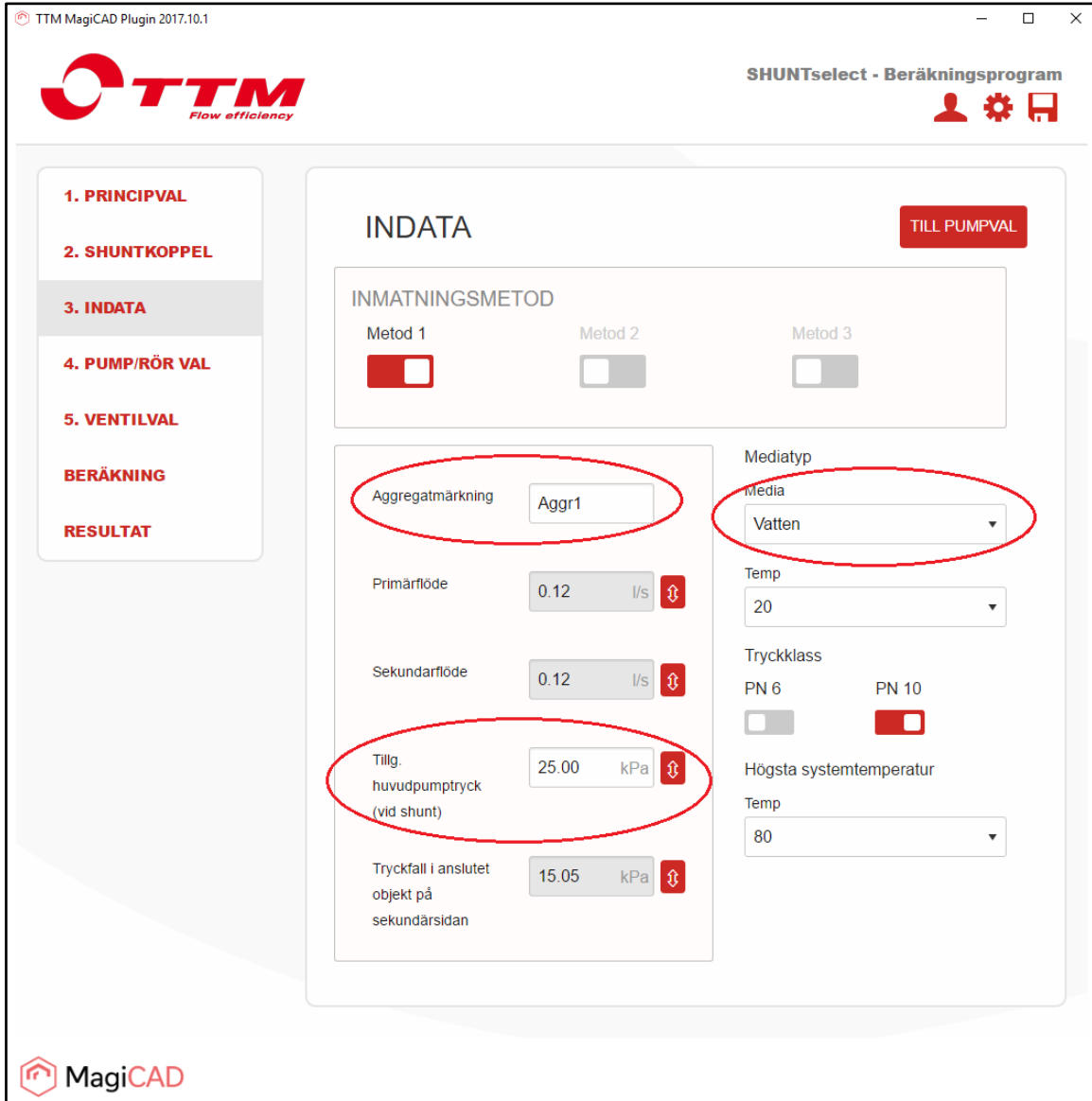

Figure 4 TTM calculation program start view

6. Calculation input parameters are set based on selected MagiCAD system and selected secondary circuit pipes. The user has to input a user code, estimated primary circuit minimum driving pressure and select media type in order to proceed the calculations (highlighted with red).



TTM MagiCAD Plugin 2017.10.1

**TTM**  
Flow efficiency

SHUNTselect - Beräkningsprogram

1. PRINCIPVAL  
 2. SHUNKOPPEL  
 3. INDATA  
 4. PUMP/RÖR VAL  
 5. VENTILVAL  
 BERÄKNING  
 RESULTAT

**INDATA** TILL PUMPVAL

INMATNINGSMETOD

Metod 1  Metod 2  Metod 3

Aggregatmärkning

Primärflöde  l/s

Sekundärflöde  l/s

Tillg. huvudpumptryck (vid shunt)  kPa

Tryckfall i anslutet objekt på sekundärsidan  kPa

Mediatyp  
 Media

Temp

Tryckklass  
 PN 6  PN 10

Högsta systemtemperatur  
 Temp

MagiCAD

Figure 5 TTM calculation program input data



- Selected product can be exported to MagiCAD from the final page of the TTM calculation program. User clicks the insert button (highlighted with red) to insert the dimensioned shunt unit to MagiCAD.

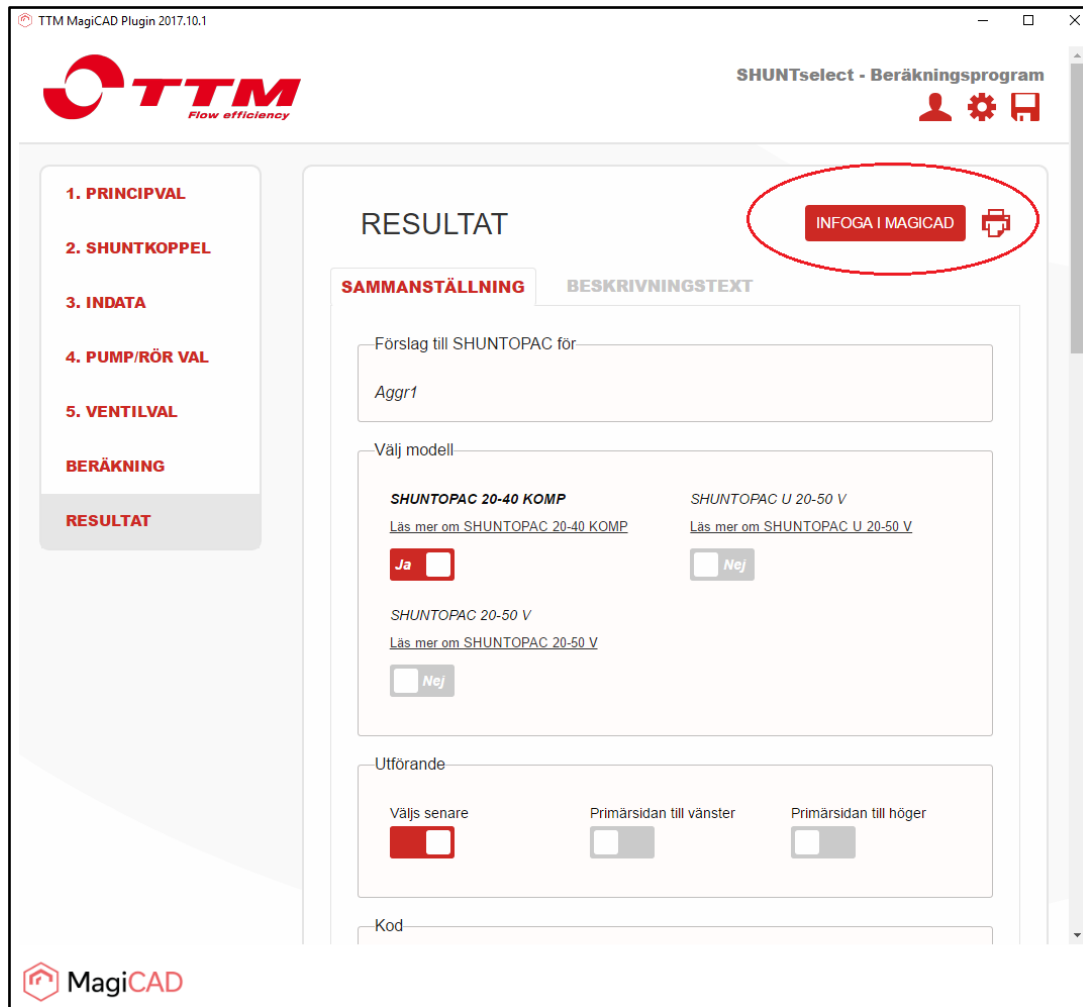
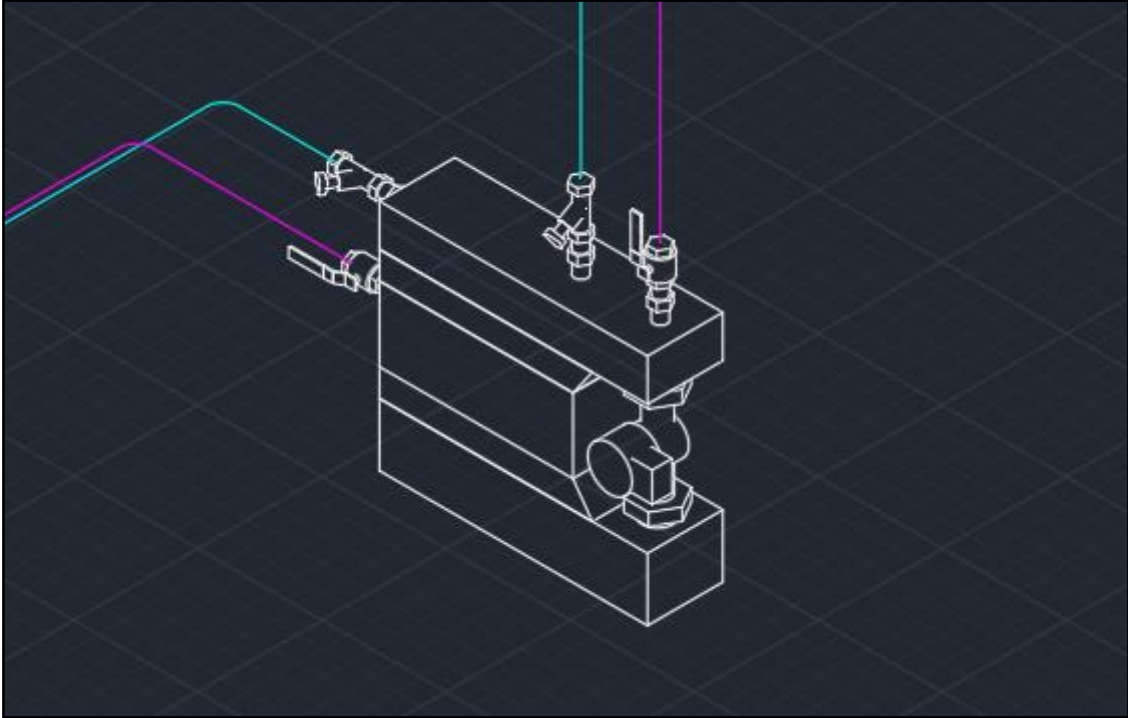

Figure 6 TTM calculation done and insert shunt unit in to MagiCAD

8. Once the shunt unit is inserted to MagiCAD it should be connected to primary and secondary circuits. After the needed shunt units are inserted to the MagiCAD, user runs the MagiCAD balancing calculation for necessary primary and secondary circuits.



*Figure 7 Shunt inserted and connected to circuits*

### Detailed copy operation

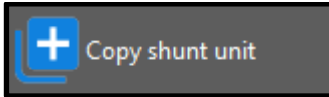

This operation allows user to copy an existing TTM shunt unit within the drawing. The copied shunt unit can be pasted single or multiple times into the drawing.

1. Click the "Copy shunt unit" button from TTM MagiCAD plugin ribbon panel or give the "TTM\_COPY" command.
2. User is then asked to select the shunt unit to be copied.

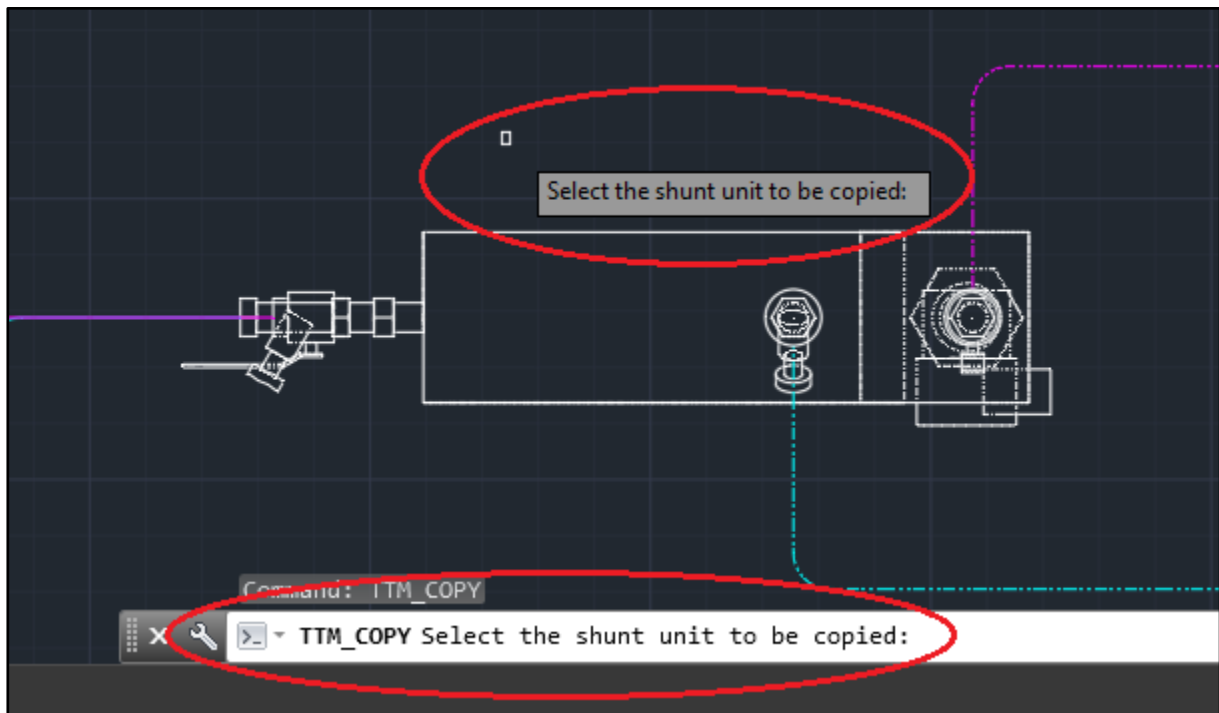

Figure 8 Prompts for selecting the shunt unit

- After selecting an existing valid shunt unit from the drawing user is prompted with a dialog to select a secondary system for the new shunt unit copy, from a dropdown list. User is also asked to write a new user code for the product before continuing.

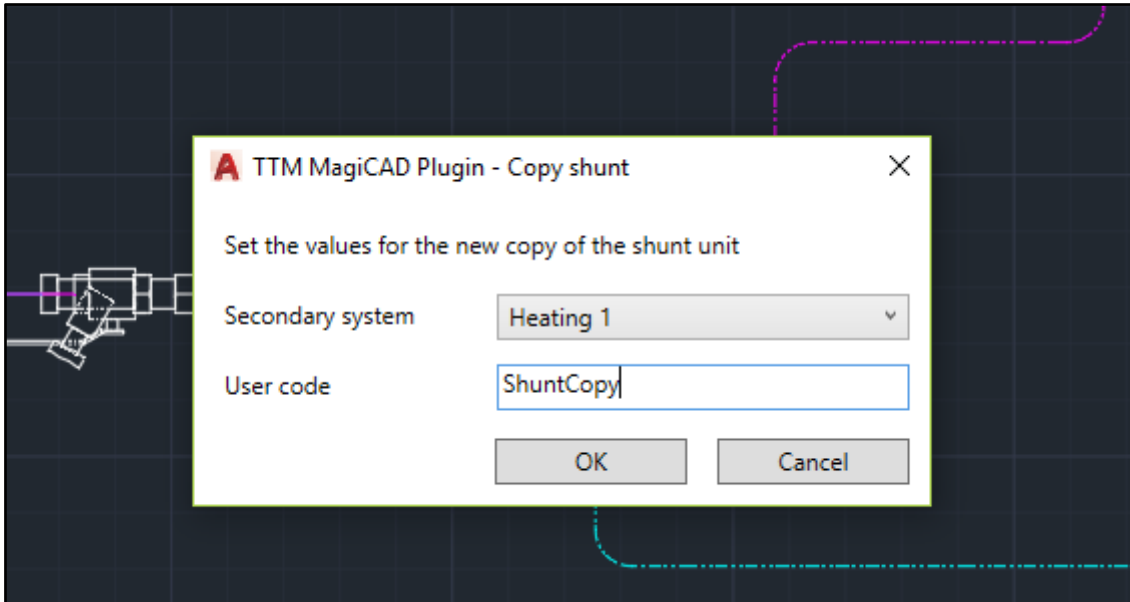
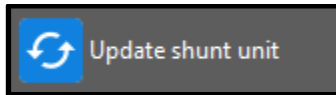

Figure 9 Copy shunt dialog

- After pressing OK user can paste the newly copied shunt unit into the drawing. This is done with the same principle as shunt insert after dimension.
- When user has positioned the shunt unit into the drawing, the same dialog as before is opened again asking if the user wants to paste another copy of the selected shunt unit. User can add a new copy of the original by filling the required information and pressing OK. This can be repeated multiple times.
- After inserting the last copy of shunt unit user will press cancel from the dialog and connect all the inserted shunt copies to the necessary circuits.

## Detailed update operation



Shunt(s) should be updated after the primary circuit is finished. The reason for this is that the TTM calculation program will now get the accurate driving pressure value straight from MagiCAD instead of an estimation from the user.

Before updating the shunts make sure that the shunts are connected to the pipework and the MagiCAD balancing calculation has been done for the systems to which the updated shunts are connected to.

After updating the shunts make sure that the shunts are connected to the pipework in case of changed geometry. Run the MagiCAD balancing again to make sure that the pipework and shunts are up to date.

During the update shunt unit operation user can make changes to shunt unit details like the user code can be changed.

1. Click the “Update shunt unit” button from TTM MagiCAD plugin ribbon panel or give the “TTM\_UPDATE” command.
2. When update shunt unit operation is started, user is first prompted to select the shunt unit to be updated. User selects only one shunt unit for update. In case of need to update multiple shunt units user should use the recalculate operation.

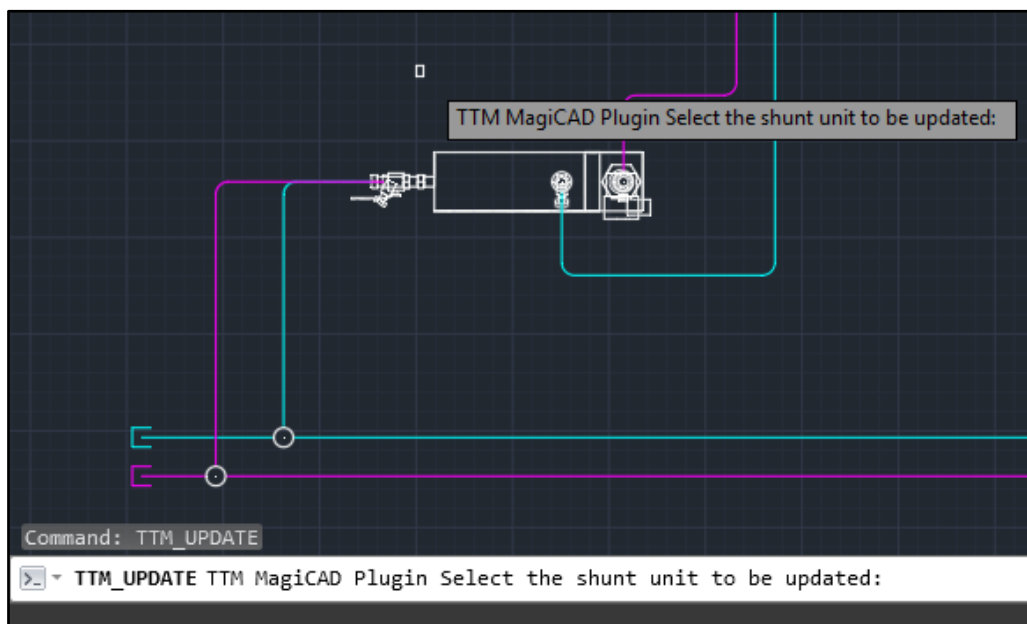

Figure 10 Prompt for selecting the shunt unit for update

- After the selection is done TTM calculation program is opened and user may do some dimension changes in there. Plugin sends the shunt and circuits data to calculation program and they can be seen prefilled in the program. Values which are not greyed are user editable values.



Figure 11 TTM calculation program in shunt update mode with prefilled values

- After user has gone through the dimensioning and made the needed changes to the shunt unit it can be exported to MagiCAD from final page of the TTM calculation program. User clicks the insert button (highlighted with red) to insert the updated shunt unit to MagiCAD.



Figure 12 Inserting updated shunt unit in to MagiCAD

5. After pressing the insert to MagiCAD button, the dialog informs user that shunt unit has been updated. It also informs if the unit geometry has been changed or not. If the shunt geometry is changed then user should make sure that the shunt is still connected to the circuits intended.

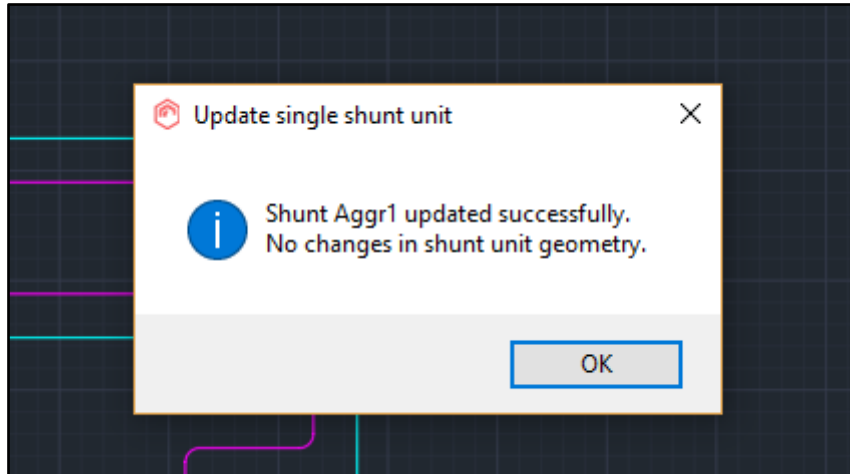

*Figure 13 Shunt unit update information dialog*



## Detailed recalculate operation

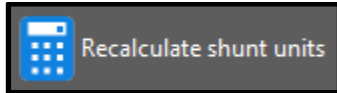

Shunt(s) should be recalculated after the primary circuit is finished. The reason for this is that the TTM calculation program will now get the accurate driving pressure value straight from MagiCAD instead of an estimation from the user.

Before recalculating the shunts make sure that the shunts are connected to the pipework and the MagiCAD balancing calculation has been done for the systems to which the shunts are connected to.

After recalculating the shunts make sure that the shunts are connected to the pipework in case of changed geometry. Run the MagiCAD balancing again to make sure that the systems can now be properly balanced.

During the recalculate shunt units operation the user can't make any changes to unit details like change the user code etc.

1. Click the "Recalculate shunt units" button from TTM MagiCAD plugin ribbon panel or give the "TTM\_RECALC" command.
2. When recalculate shunt units operation is started, user is first prompted to select the shunt units to be recalculated. User may select one or multiple shunt units for recalculation.

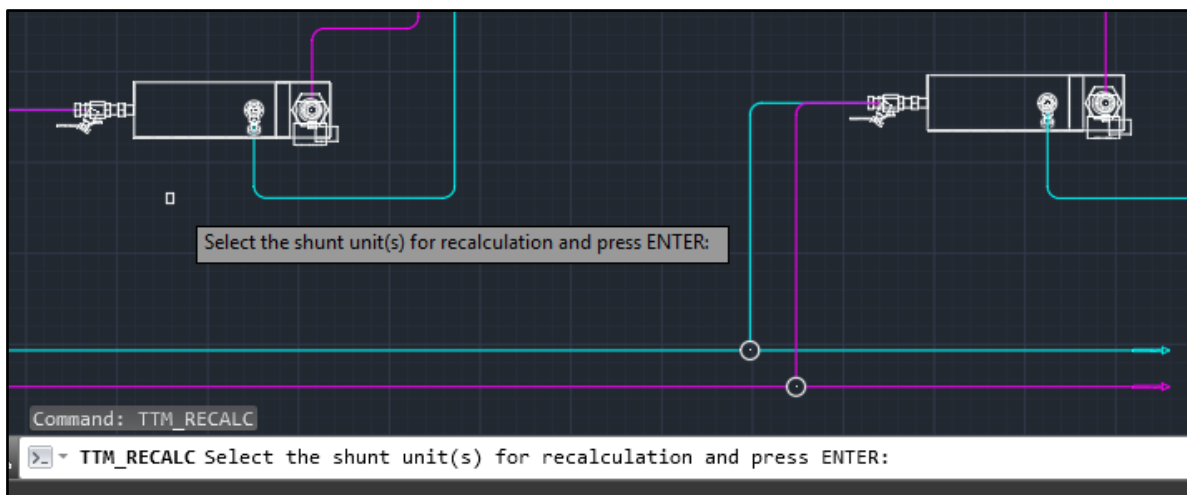

Figure 14 User prompted to select shunt units for recalculation

- After the selection is done plugin informs user how many units was selected and TTM calculation program is opened. Plugin sends the shunt data to program and user sees the recalculation process.

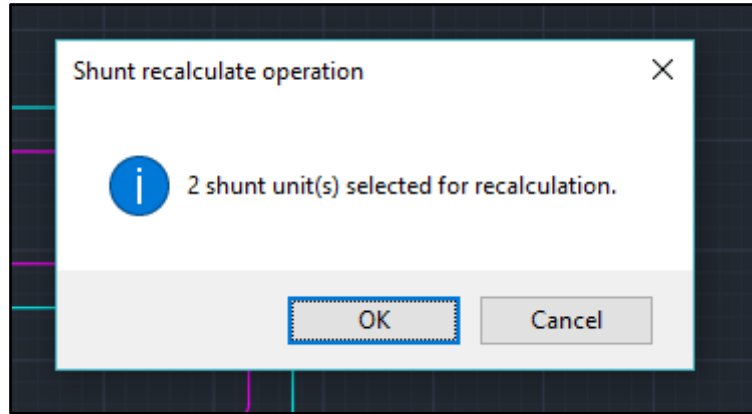

Figure 15 Dialog informing user that how many shunt units selected



Figure 16 TTM calculation program in recalculation operation

- After the recalculation is done plugin shows to user the results of the recalculation: "Calculation status" and the "Operation type" (highlighted in red). Operation type indicates the type of operation which will be made to the shunt unit if user updates the drawing.

If status is "Success" then the operation will be "Unit data update" or "Unit replacement". In case of "Unit data update" only the data of unit is changed and no geometrical changes are made to the shunt unit. In case of "Unit replacement", shunt unit data and geometry is changed. In this case user should re-connect the shunt unit to the circuits intended.

If status is error then shunt unit update operation is recommended. Operation column guides user to do that. In update operation user can more easily see what has caused the error in calculation.

User can make a final decision to update the results to drawing or cancel them.

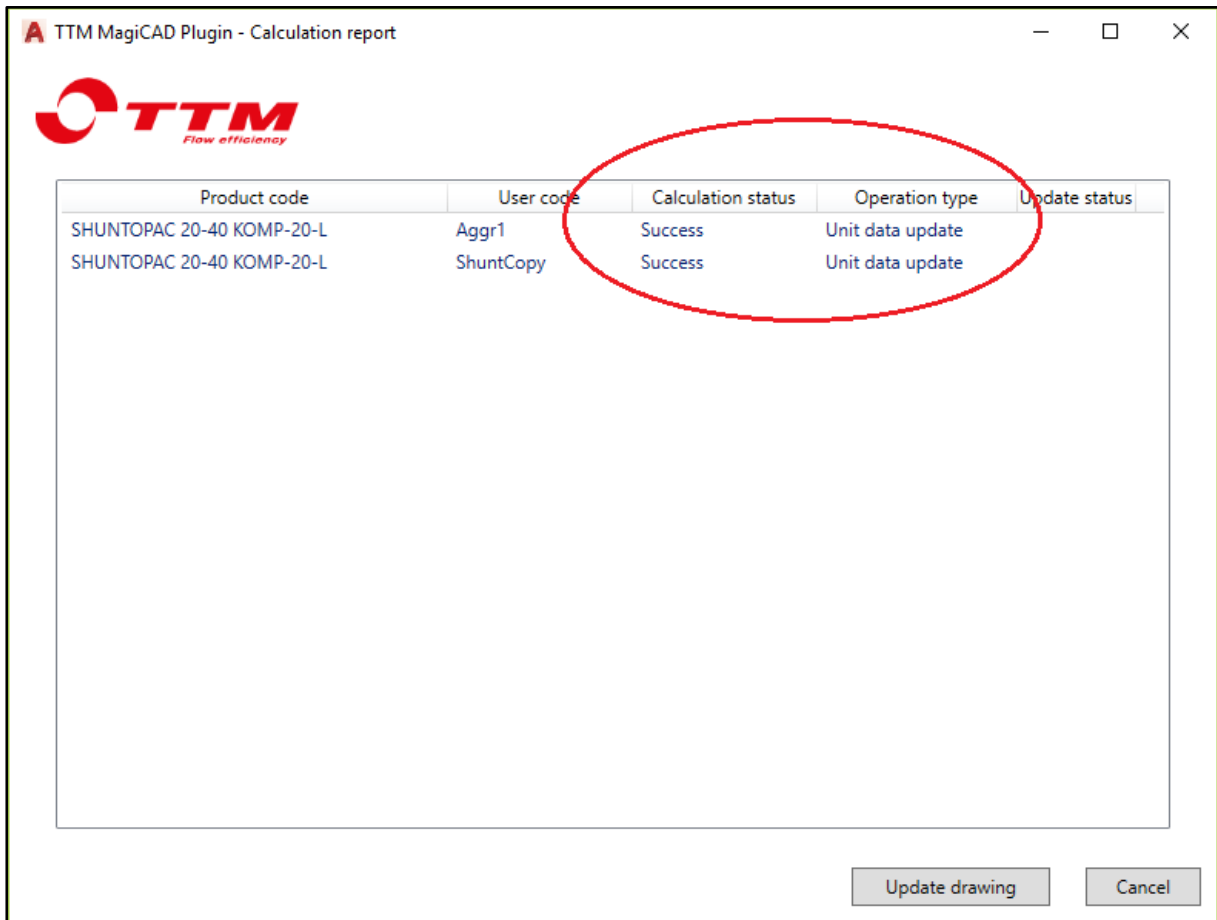

Figure 17 Shunt unit calculation report dialog before units updated to MagiCAD

5. When user selects to update the drawing then the results will be shown in the dialog “Update status” column (highlighted in red). If calculation is failed for certain shunt unit then the drawing will not be updated at all by that shunt. The status column stays empty for that shunt.

In case of “Unit data update” operation type “Updated” status will be shown. In case of unit replacement “Replaced” status will be shown.

In case of failure in updating the drawing the “Failed” status is shown.

Close the dialog from OK button.

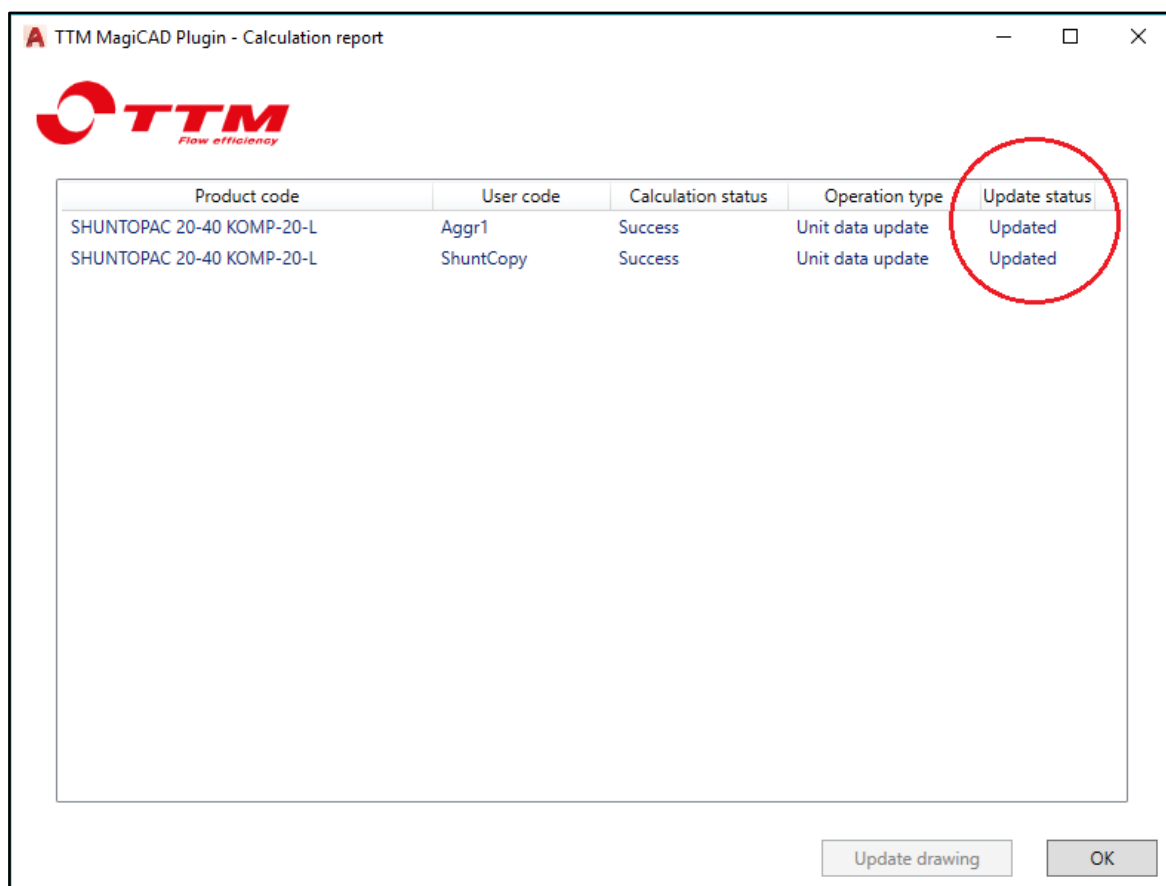
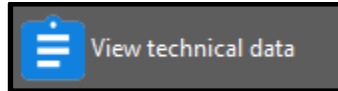

Figure 18 Shunt unit calculation report dialog after units updated to MagiCAD

## Detailed view technical data operation



1. Click the "View technical data" button from TTM MagiCAD plugin ribbon panel or give the "TTM\_VIEW" command.
2. When technical data operation is started user is prompted to select the shunt unit which technical data is wanted to view.

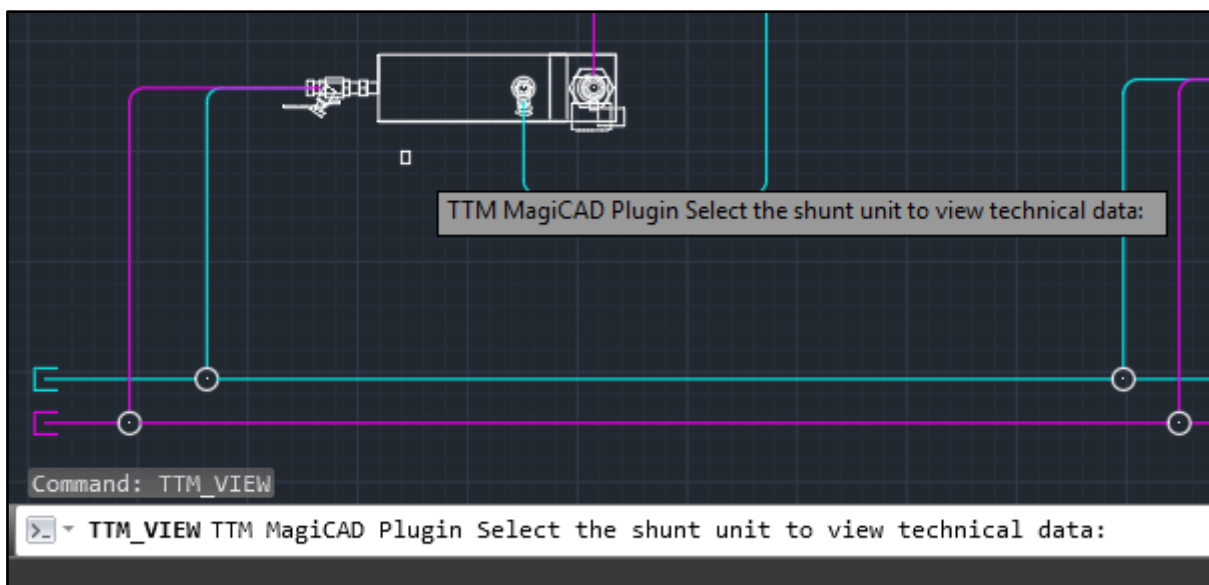

Figure 19 Plugin guides user to select shunt unit which technical data is viewed

3. After the user selection the following dialog will be shown:

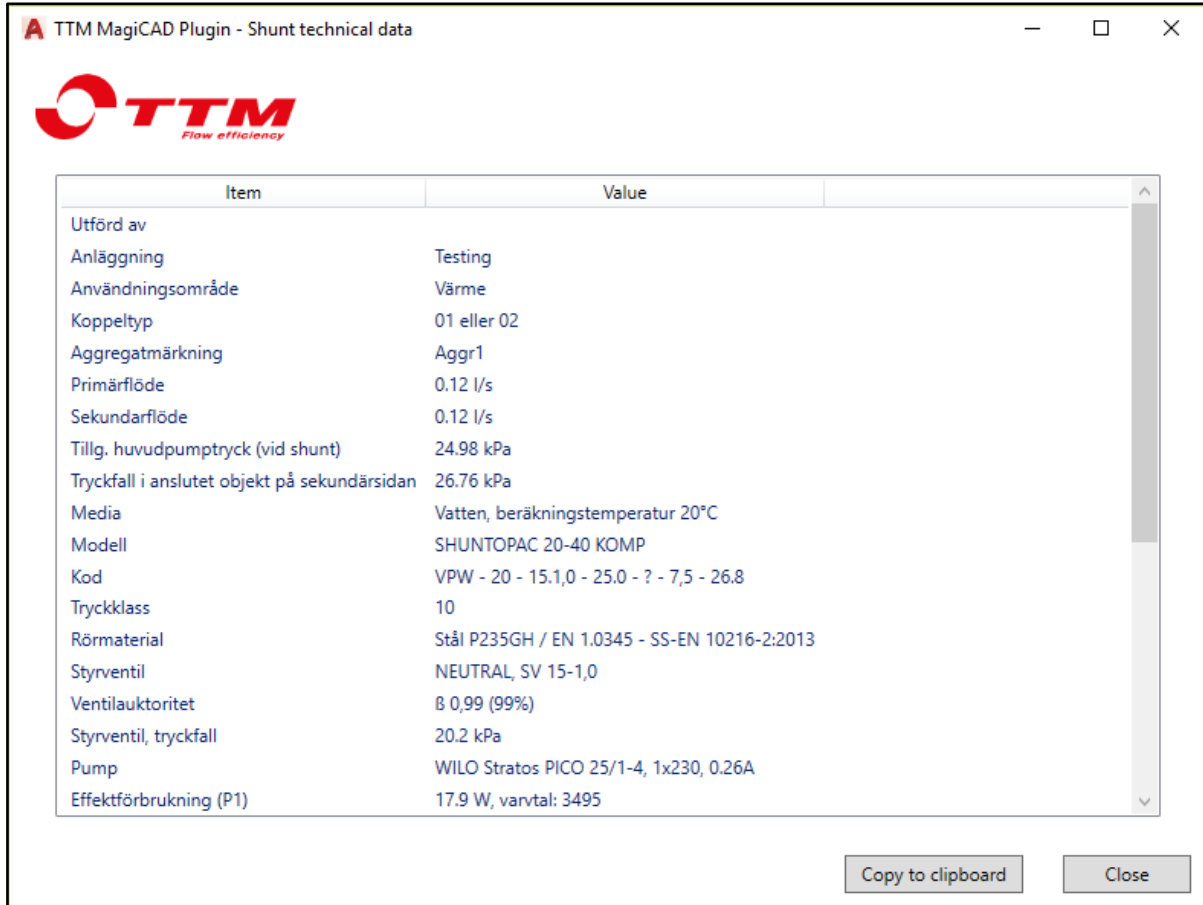

Figure 20 Shunt unit technical data dialog

Copy to clipboard functionality copies the content of the listview to clipboard. This allows shunt unit technical data transfer to user's own documentation.