



# **FläktGroup MagiCAD for AutoCAD Plugin**

User guide

03/06/2024

**Content**

<b>ABOUT THIS DOCUMENT .....</b>	<b>3</b>
<b>INSTALLING THE SOFTWARE .....</b>	<b>4</b>
Required MagiCAD version .....	4
Installation.....	4
<b>STARTING THE PROGRAM .....</b>	<b>5</b>
<b>INSERTING COOLING BEAM .....</b>	<b>7</b>
<b>INSERTING AIR TERMINAL DEVICE.....</b>	<b>10</b>
<b>UPDATING SELECT PRODUCT.....</b>	<b>10</b>
<b>INSERTING AIR HANDLING UNIT .....</b>	<b>11</b>
<b>VIEW UNIT DATA .....</b>	<b>15</b>

## About this document

The purpose of the FläktGroup MagiCAD Plugin is to use Select or Acon directly from MagiCAD as a product configurator, when adding FläktGroup products into MagiCAD for AutoCAD project / drawing.

FläktGroup MagiCAD Plugin is an AutoCAD ARX application which calls FläktGroup selection software (Select/Acon) with input parameters to calculate device, transfer device geometry, technical data and calculation results from Select/Acon into MagiCAD and installs the transferred device into MagiCAD drawing.

**Note!** This plugin replaces existing Select MagiCAD plugin.

## Installing the software

### Required MagiCAD version

FläktGroup MagiCAD Plugin works with the following MagiCAD versions

- MagiCAD 2024 and AutoCAD 2022-2024
- MagiCAD 2025 and AutoCAD 2022-2025

### Installation

1. Ensure that you have required MagiCAD and AutoCAD versions installed on your computer
2. Install FläktGroup MagiCAD Plugin

Plugin (64-bit) can be downloaded from

<https://portal.magicad.com/download/ProductSearch?searchStr=Fläkt&categoryId=3>

Run the FläktGroup MagiCAD plug-in installer on your workstation

**Administrator privileges are recommended for installation.**

**Note if you have several AutoCAD versions on your workstation:** Before you run the installation program, start MagiCAD to make sure that FläktGroup MagiCAD Plugin installs on the same AutoCAD platform as MagiCAD.

## Starting the program

Before you start using *FläktGroup MagiCAD Plugin*, start MagiCAD and open or create a new Ventilation & Piping project.

In case where toolbar or ribbon panel button is not visible in AutoCAD after installation run **CULOAD** or **MENULOAD** in AutoCAD, and browse the customization file from the directory where you installed the program (by default, the directory is *C:\Program Files\FlaktGroup\FlaktGroup MagiCAD plugin*).

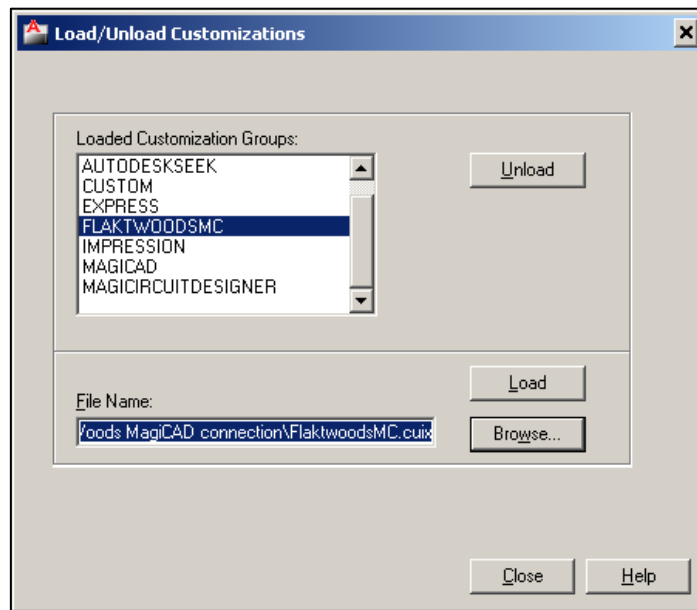

When you select Load, FläktGroup toolbar and ribbon panel button appears on the AutoCAD.

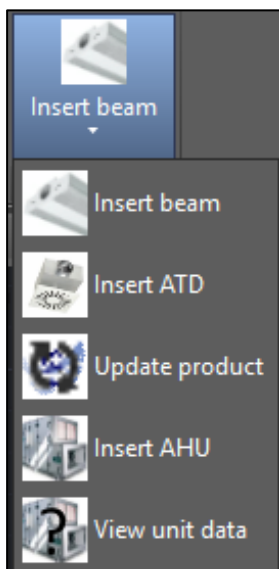

**Information for the network administrators:**

*Plugin requires connection to FlåktGroup web site. EO.WebBrowser for .NET is used to browse to the web page.*

*Standard HTTP GET (TCP, default port 80 should be used) method is used to retrieve files from the server. GET response includes file (mime application/octet-stream). Your network firewall should allow such connections.*

## Inserting cooling beam

1.



Select Insert beam button to start Select program. After Select has started, the right chilled beam can be selected from the page.

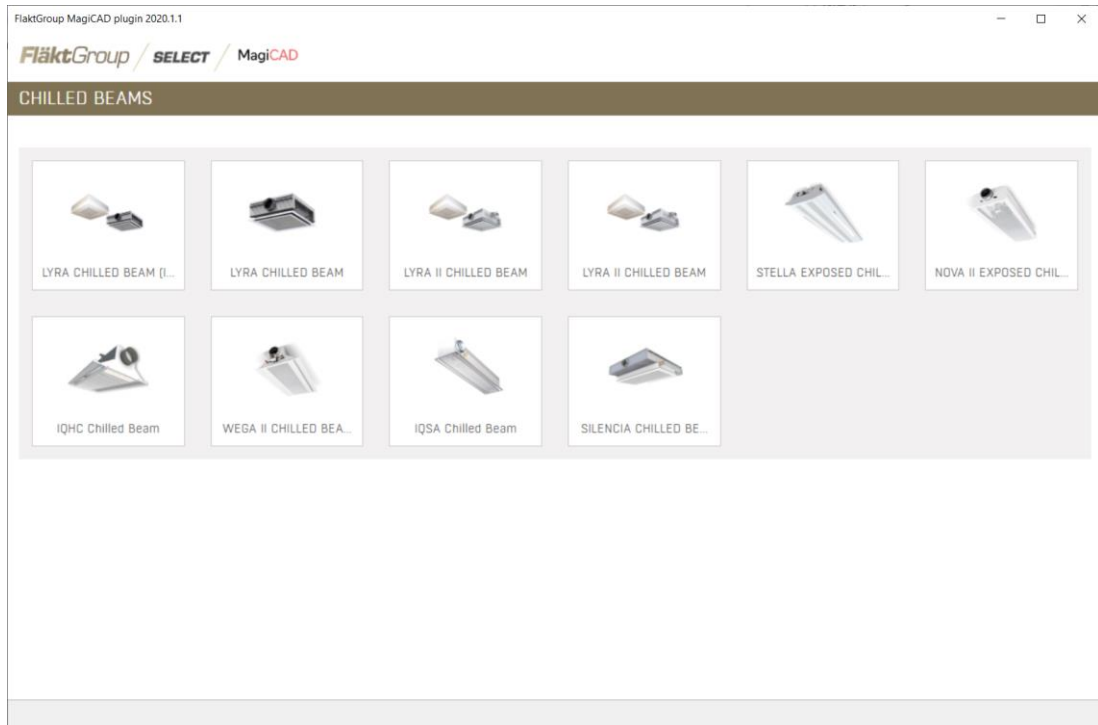

- The appropriate product variant should be configured on Select Calculation –page.

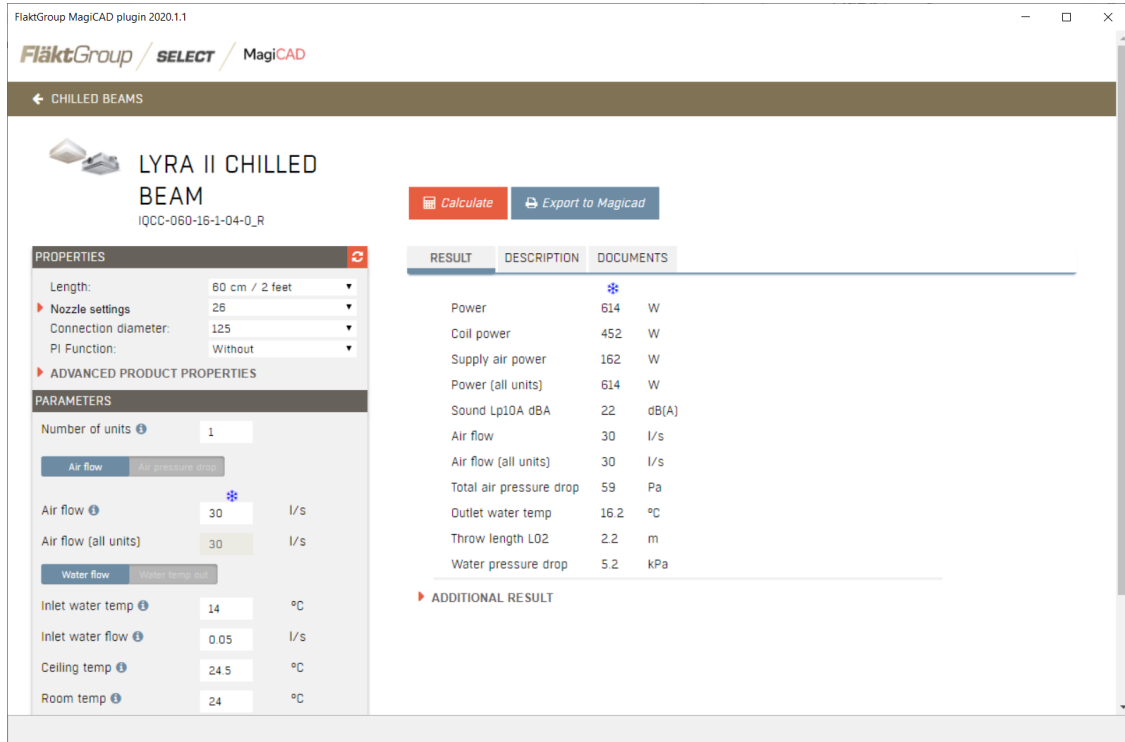

- Export to MagiCAD -button is enabled if product is possible to transfer to MagiCAD.
- Before product is inserted to MagiCAD drawing/project, user is asked to give user code for the product.

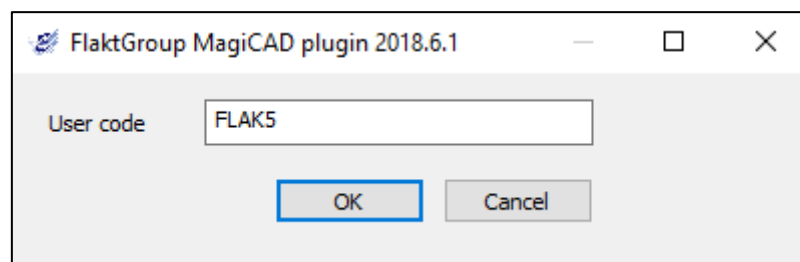



5. After this user needs to select the right systems for the product.

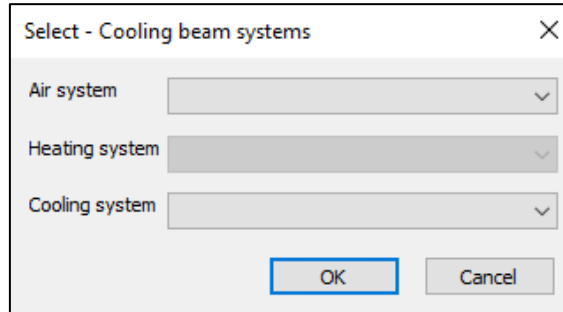

6. Product is now exported to MagiCAD and user can continue working with MagiCAD. e.g connect it to duct system and view product properties.

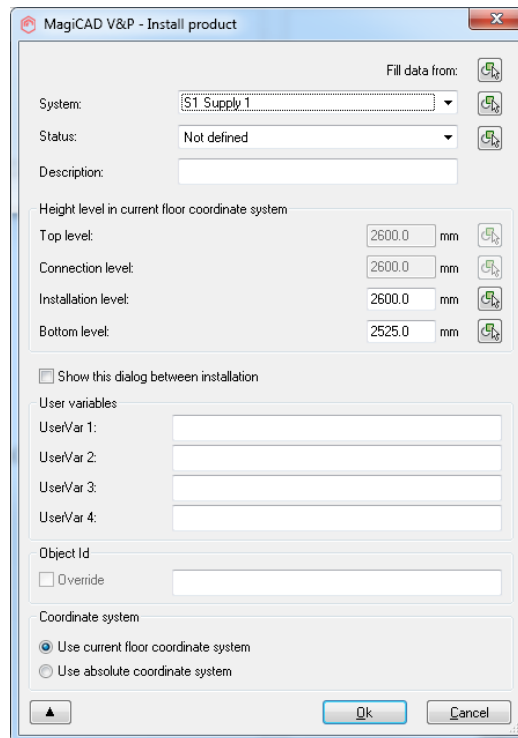
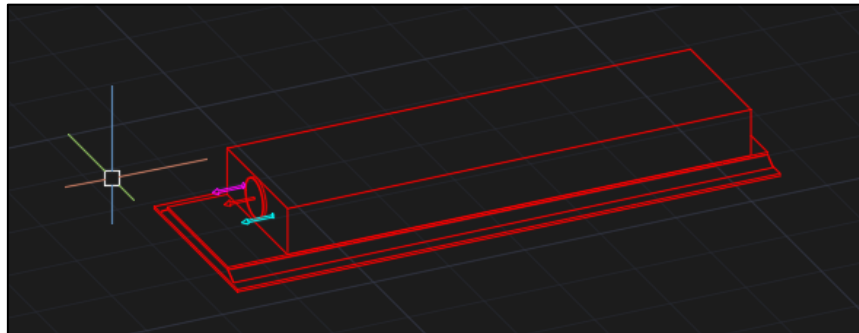

## Inserting air terminal device



Inserting air terminal device works similar to inserting beam.

Besides exported product variant, also other variants from the same product are exported so user can easily change e.g. size without exporting a new product.

## Updating Select product



1. Select Insert beam button to start updating product exported from Select to another product in Select.
2. Select product exported from Select.
3. Select starts.
4. Select new product which should replace selected product in MagiCAD.
5. Press Export to MagiCAD.
6. MagiCAD Find and Replace –dialog opens up.

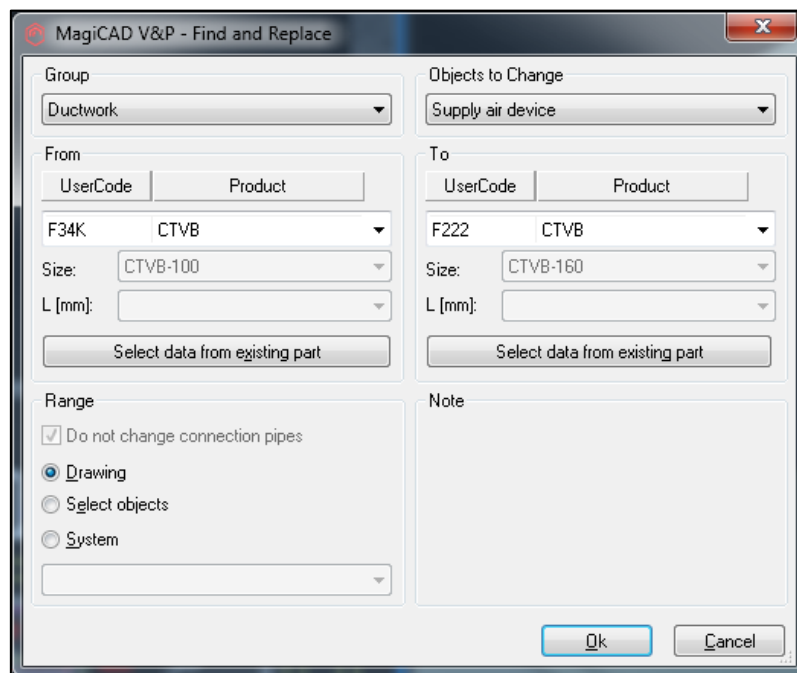

Select *Range* you want to make the update in.

7. By pressing Ok, requested product update will be done in the drawing.

## Inserting air handling unit

- 
 Select button to start inserting FläktGroup air handling unit which is created in FläktGroup configurator (Acon) to MagiCAD. The following dialog opens up.

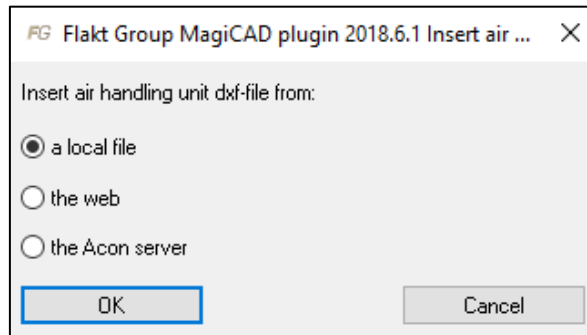

- Insert air handling unit DXF file from a local file

Open DXF file which you have exported from FläktGroup configurator (Acon) selection program.

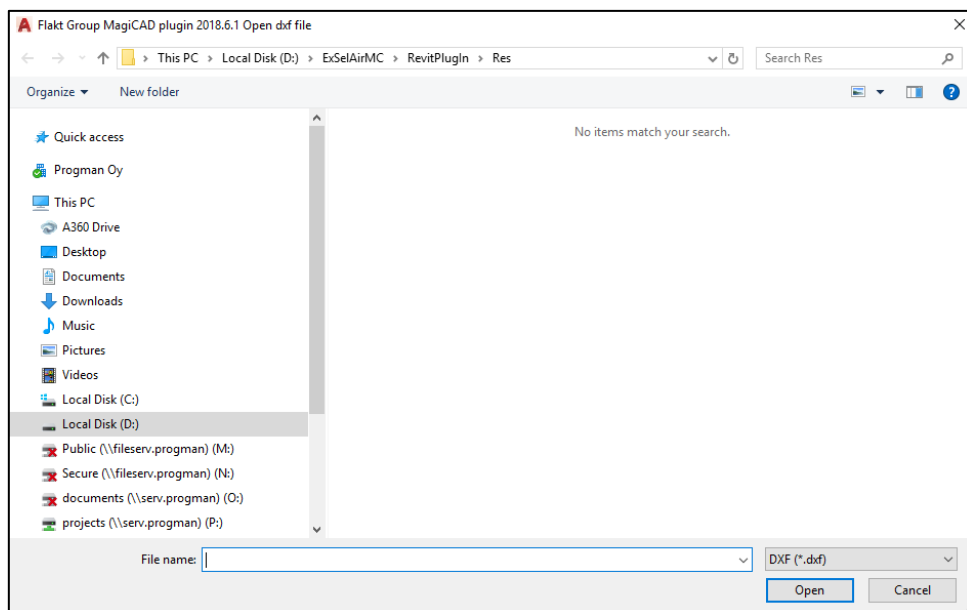

Before unit is added to MagiCAD, you can see unit information, select unit system and select air system for the duct (if there is more than one)

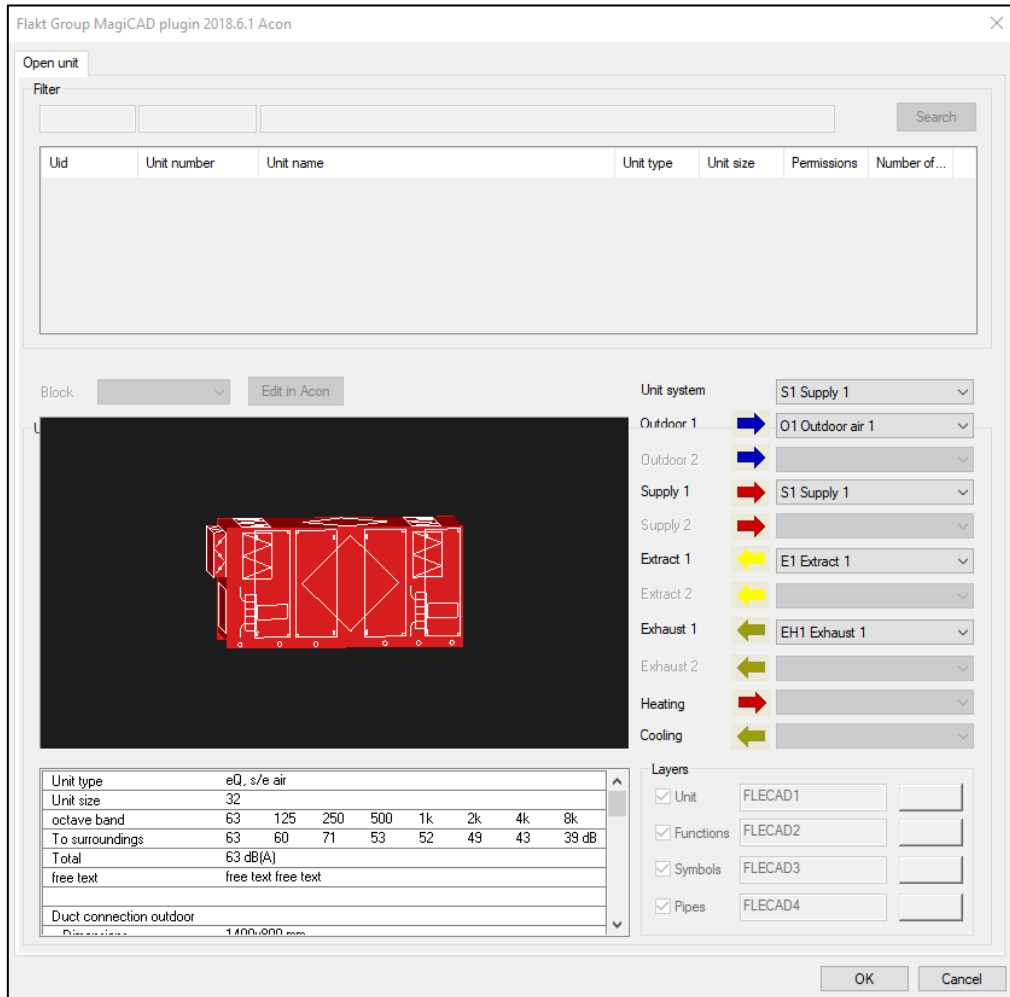

- Inset air handling unit DXF file from the web.  
Give link address to field

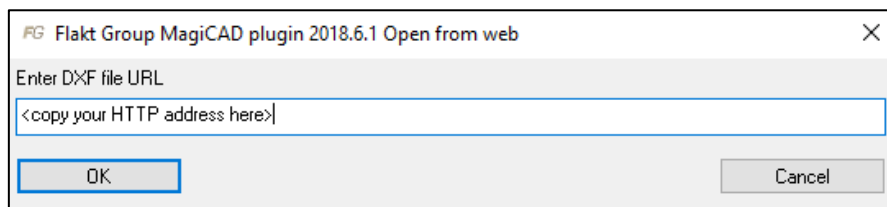

4. Inset air handling unit DXF file from the Acon server:

Give your user id and password (same than in FläktGroup configurator (Acon)) and log in.

You will see your project(s) in list. Select one project and move to "Open unit"-page

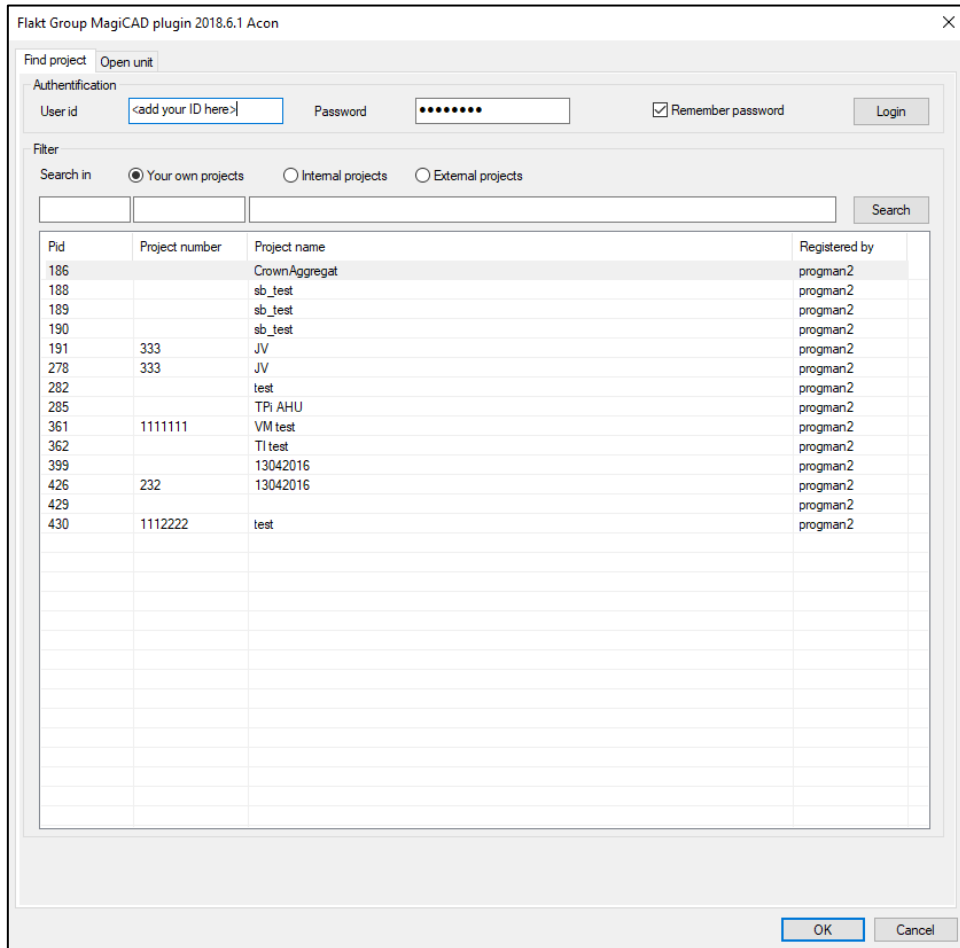

Pid	Project number	Project name	Registered by
186		CrownAggregat	progman2
188		sb_test	progman2
189		sb_test	progman2
190		sb_test	progman2
191	333	JV	progman2
278	333	JV	progman2
282		test	progman2
285		TPi AHU	progman2
361	1111111	VM test	progman2
362		Tl test	progman2
399		13042016	progman2
426	232	13042016	progman2
429		test	progman2
430	1112222	test	progman2

Select unit. If there are duct components for the unit, you can choose those in block combo. The unit and air side systems have default values, change those if needed.

Flakt Group MagiCAD plugin 2018.6.1 Acon

Find project Open unit

Filter

UId	Unit number	Unit name	Unit type	Unit size	Permissions	Number of...
81				032		6
158		EQ2 test		008		1
199				041		2
258				032		1
292		wefr		068		1
294				068		1
298		Test THomas EQTL		050		1
321				041		1

Block 1 Edit in Acon

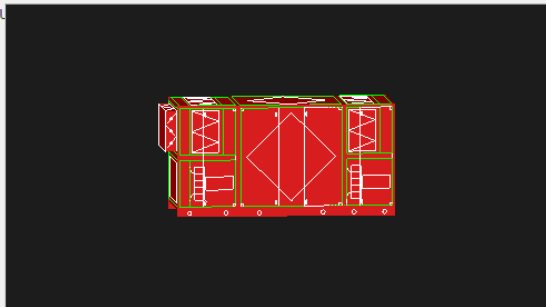

Unit system: S1 Supply 1

- Outdoor 1: O1 Outdoor air 1
- Outdoor 2: [Dropdown]
- Supply 1: S1 Supply 1
- Supply 2: [Dropdown]
- Extract 1: E1 Extract 1
- Extract 2: [Dropdown]
- Exhaust 1: EH1 Exhaust 1
- Exhaust 2: [Dropdown]
- Heating: [Dropdown]
- Cooling: [Dropdown]

Unit type	eQ, s/e air							
Unit size	32							
octave band	63	125	250	500	1k	2k	4k	8k
To surroundings	63	60	71	53	52	49	43	39 dB
Total	63 dB(A)							
free text	free text free text							
Duct connection outdoor	1400/600 mm							

Layers

- Unit: FLECAD1 (Red)
- Functions: FLECAD2 (Green)
- Symbols: FLECAD3 (Black)
- Pipes: FLECAD4 (Cyan)

OK Cancel

## View unit data



Select button to view unit data of the AHU.

Flakt Group MagiCAD plugin 2018.6.1 Acon

Open unit

Filter

Uid	Unit number	Unit name	Unit type	Unit size	Permissions	Number of...

Block: 1 Edit in Acon

Unit system: S1 Supply 1

- Outdoor 1: O1 Outdoor air 1
- Outdoor 2:
- Supply 1: S1 Supply 1
- Supply 2:
- Extract 1: E1 Extract 1
- Extract 2:
- Exhaust 1: EH1 Exhaust 1
- Exhaust 2:
- Heating:
- Cooling:

Layers

- Unit: FLECAD1
- Functions: FLECAD2
- Symbols: FLECAD3
- Pipes: FLECAD4

Unit type	eQ, s/e air							
Unit size	32							
octave band	63	125	250	500	1k	2k	4k	8k
To surroundings	63	60	71	53	52	49	43	39 dB
Total	63 dB(A)							
free text	free text free text							
Duct connection outdoor	1400x900 mm							

OK Cancel