



Siemens MagiCAD Plugin

User guide

03/06/2024

Content

GENERAL	3
About this document	3
Installing the software	3
Required third-party software	3
Before installation	3
Installation	3
Starting the program	4
FUNCTIONS	5
Siemens MagiCAD plugin UI overview	5
Insert VARISHUNT units operation	5
Insert Reglershunt and Easys Hunts operation	5
Copy operation	5
Update operation	5
Recalculate operation	6
Mirror operation	6
View technical data operation	6
Detailed insert operation with VARISHUNT units	7
Detailed insert operation with Regleshunt and EasyShunt units	16
Detailed copy operation	27
Detailed update operation	29
Detailed recalculate operation	34
Detailed mirror operation	39
Detailed view technical data operation	41

General

About this document

This document contains instructions on using Siemens MagiCAD plugin.

Siemens MagiCAD plugin allows user to insert, copy, update, recalculate and view the technical data of the shunt units with MagiCAD.

Plugin supports the control & balancing valve shunt units with static and variable flow systems, adjustable control valve shunt units and dynamic pressure independent control valve shunt units.

Installing the software

Required third-party software

Siemens MagiCAD plugin works with the following MagiCAD and AutoCAD versions

- MagiCAD 2024 and AutoCAD 2021-2024
- MagiCAD 2025 and AutoCAD 2021-2025

Before installation

1. Workstation administrator privileges are recommended for installation.
2. Notice if you have several AutoCAD versions on your workstation. Before you run the plugin installer, start MagiCAD to make sure that Siemens MagiCAD Plugin installs on the same AutoCAD platform as MagiCAD.

Installation

1. Download the installer file from MagiCAD portal to your workstation:

<https://portal.magicad.com/Download/ProductSearch?searchStr=Siemens&categoryId=3>

2. Run the Siemens MagiCAD plugin installer on your workstation.

Starting the program

The plugin is automatically loaded and is ready to be used once MagiCAD is started next time after the plugin is installed.

Before you start using the Siemens MagiCAD plugin, (re)start the MagiCAD and open a Heating and piping project.

Locate the MagiCAD plugins tab from the AutoCAD ribbon. Once the Siemens MagiCAD plugin is loaded its ribbon panel can be found from the MagiCAD plugins tab. When the drop-down button is clicked the list of available operations will be shown.

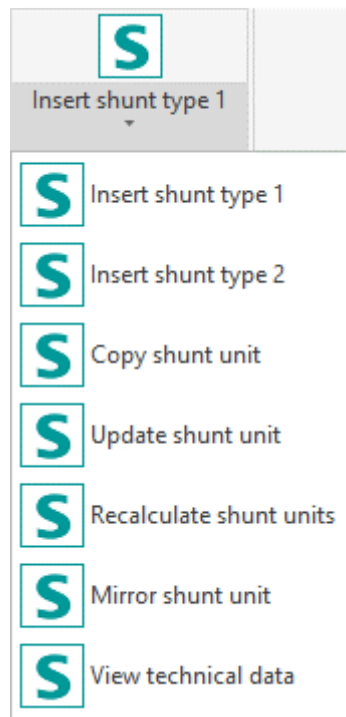

Figure 1 Plugin ribbon panel and operation buttons

Functions

Siemens MagiCAD plugin UI overview

Plugin contains the following operations:

Insert VARISHUNT units operation

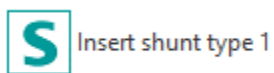

This command inserts a new VARIHUNT unit to MagiCAD with shunt sizing application.

Insert Reglershunt and Easyshunts operation

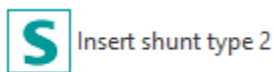

This command insert a new EasyShunt or Reglerhunt unit to MagiCAD with sizing application.

Copy operation

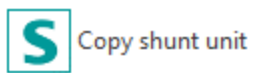

This command makes shunt unit inserting faster in MagiCAD without going through the shunt sizing application insert operation.

Update operation

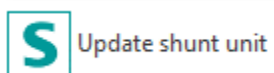

This command updates one shunt unit with the shunt sizing application and finally updates the data to shunt unit in MagiCAD.

Recalculate operation

Recalculate operation is not available at the moment.

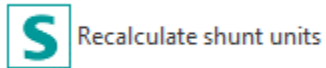

This command recalculates one or multiple shunt units with shunt sizing recalculation application and finally updates the data to shunt units in MagiCAD.

Mirror operation

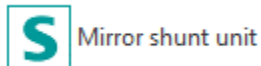

This command mirrors the selected shunt unit in MagiCAD.

View technical data operation

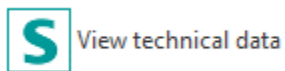

This command is for viewing the shunt sizing application generated technical data of the shunt unit in MagiCAD.

Detailed insert operation with VARISHUNT units

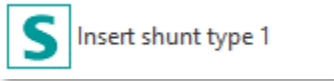

Follow these steps to insert Siemens shunts unit to AutoCAD drawing:

1. Draw and balance the secondary circuit in MagiCAD. This is important because Siemens MagiCAD plugin sends the secondary circuit flow and pressure drop data to the shunt sizing application. These values are input parameters for unit calculation.
2. Click the “Insert shunt type 1” button from Siemens MagiCAD plugin ribbon panel or give the “SIE_INSERT_VARISHUNT” command.
3. Once the operation is started, user is first prompted to select the MagiCAD system for the shunt primary circuit. The selected system will be set for the shunt unit that is exported to the MagiCAD via plugin.

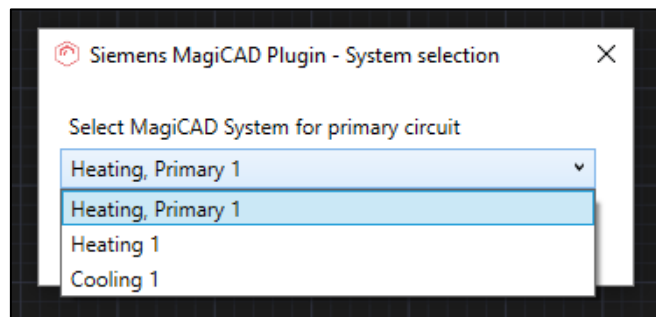

Figure 2 Selecting the primary circuit for the shunt unit

4. User is prompted to select the supply and return pipes of the secondary circuit. It is important to select that part (or near end) of the pipe that should be connected to the shunt unit. Reason for this is that plugin sends flow and pressure drop information data from the selected pipes to shunt sizing application.

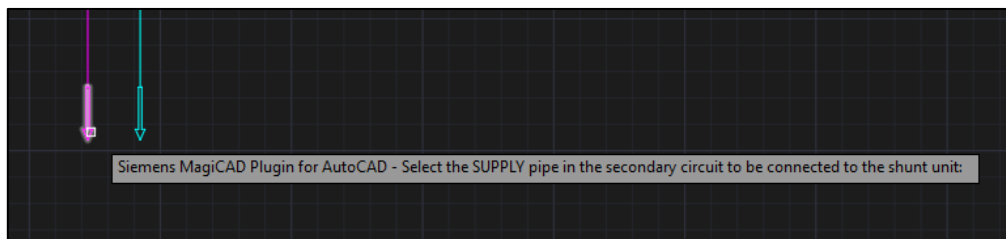

Figure 3 Selecting the supply pipe from the secondary circuit for the shunt unit

5. After secondary circuit pipe selections the shunt sizing application is started. In this step user fills the facility, position number and user code information and proceeds to the next step. This

information is not mandatory and user may proceed without filling these fields. If user code is left empty, plugin will generate a random user code for the shunt unit.

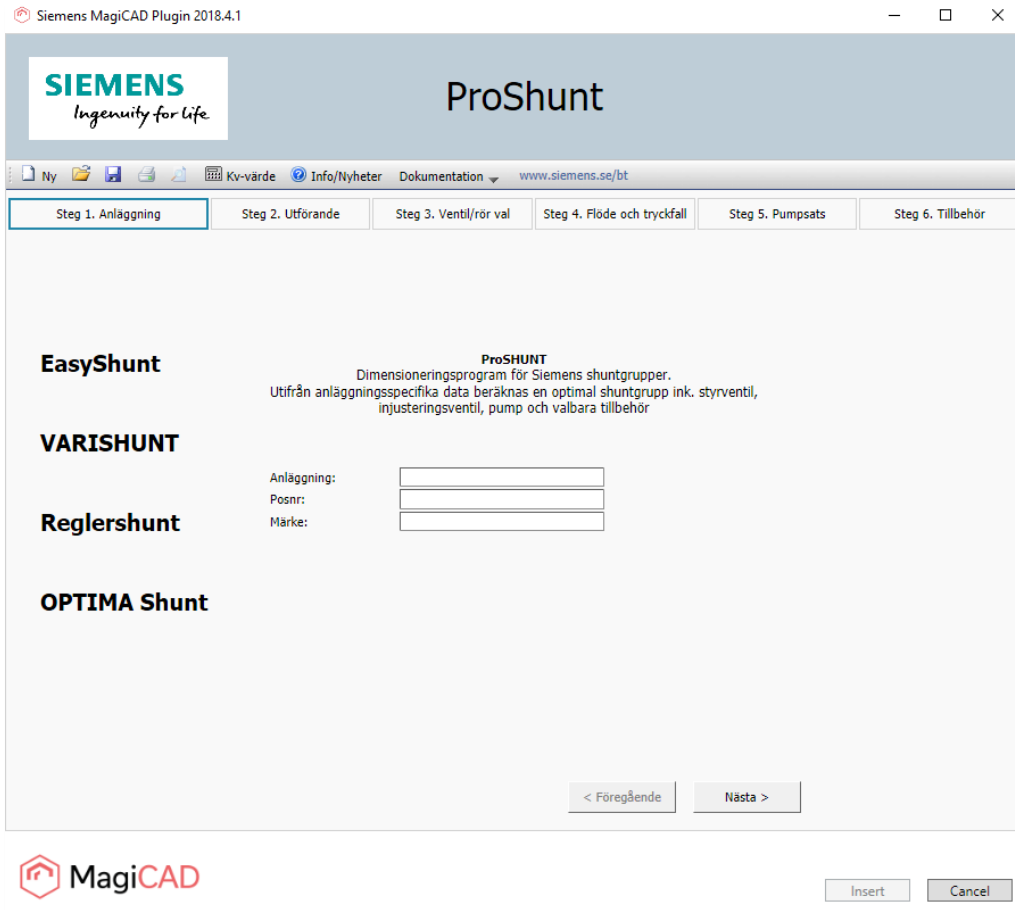

Figure 4 Step 1/6 – Start inserting of the VARISHUNT unit with shunt sizing application

6. In this step user selects the type of the shunt and proceeds to the next step.

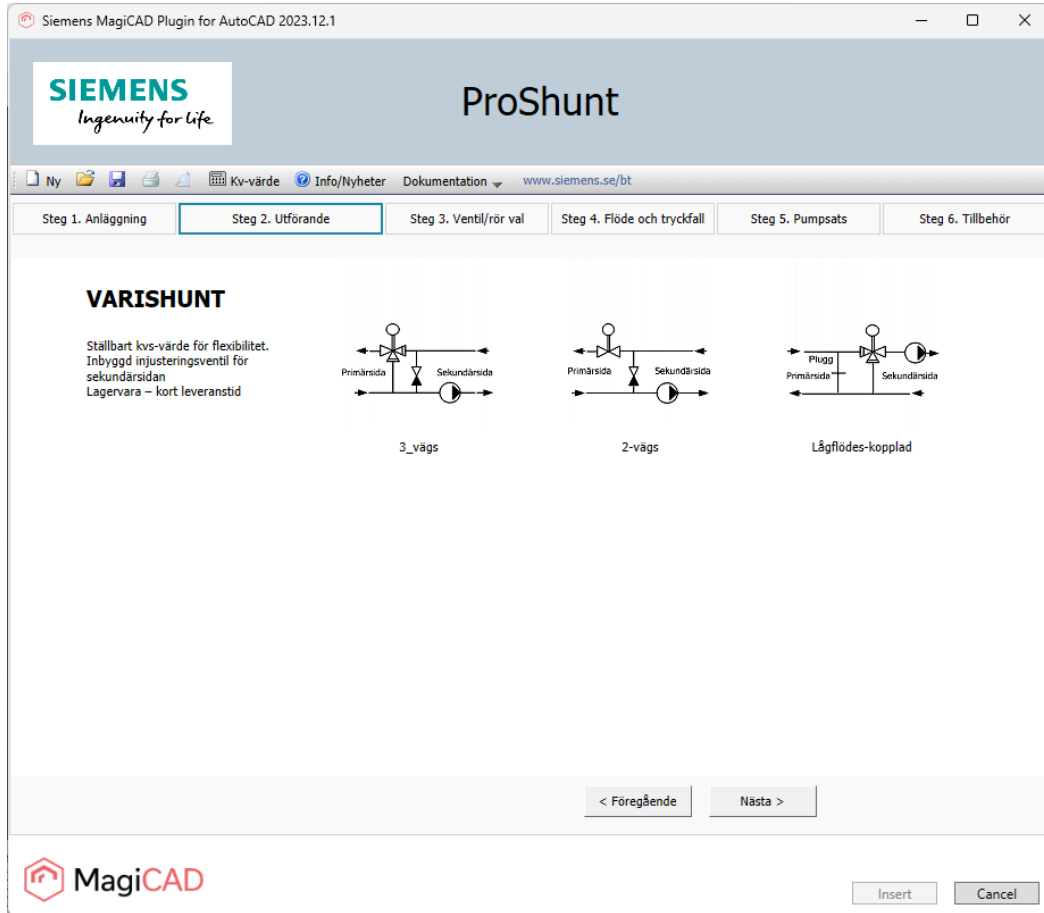

Figure 5 Step 2/6 – VARISHUNT unit type selection

7. In this step user sets the type of isolation and proceeds to the next step.

Siemens MagiCAD Plugin 2018.4.1

SIEMENS
Ingenuity for life

ProShunt

Ny | Kv-värde | Info/Nyheter | Dokumentation | www.siemens.se/bt

Steg 1. Anläggning | Steg 2. Utförande | **Steg 3. Ventil/rör val** | Steg 4. Flöde och tryckfall | Steg 5. Pumpsats | Steg 6. Tillbehör

VARISHUNT 3-vägs

Styrventil:
Styrventil * [dropdown]

Injusteringsventil:
Primär * [dropdown]
Sekundär * [dropdown]

Rör och isolering:
Rörmaterial* [dropdown]
Isolering * [dropdown] *Värmeisolerad*

< Föregående | Nästa >

MagiCAD

Insert | Cancel

Figure 6 Step 3/6 – VARISHUNT unit isolation selection

8. In this step user inserts the primary system shunt group pressure drop and refrigerant (highlighted with red). The driving pressure of the main pump is not available at this point. This is because MagiCAD primary system balancing calculation can't be accomplished before ALL shunt units in the primary circuit have been inserted into it. At this point user needs to input sophisticated guess of the main pumps driving pressure into this field.

The primary / secondary system flow and pressure drop (highlighted with green) are passed from MagiCAD plugin into sizing application and disabled for editing.

The screenshot shows the 'ProShunt' window in the Siemens MagiCAD Plugin 2018.4.1. The window title is 'Siemens MagiCAD Plugin 2018.4.1' and the main title is 'ProShunt'. The interface is in Swedish and shows 'Steg 4. Flöde och tryckfall' (Step 4. Flow and pressure drop) selected among six steps: 'Steg 1. Anläggning', 'Steg 2. Utförande', 'Steg 3. Ventil/rör val', 'Steg 4. Flöde och tryckfall', 'Steg 5. Pumpsats', and 'Steg 6. Tillbehör'. The main area is titled 'VARISHUNT 3-vägs' and contains a schematic diagram of a three-way shunt valve with 'Primärsida' (Primary side) and 'Sekundärsida' (Secondary side) labels. The input fields are as follows:

Primärt flöde *	0,1666	l/s
Tryckfall till gruppen *		Pa
Sekundärt flöde *	0,1666	l/s
Sekundärt tryckfall *	20299,27	Pa

Below the diagram is a section for 'Frysskyddsmedel:' (Refrigerant) with four dropdown menus: 'Kompensationstyp', 'Sort', 'Koncentration', and 'Temperatur'. At the bottom of the window, there are navigation buttons '< Föregående' and 'Nästa >', and 'Insert' and 'Cancel' buttons.

Figure 7 Step 4/6 - Shunt flow, pressure and refrigerant selections

9. In this step user selects the pump for shunt unit and proceeds to the next step.

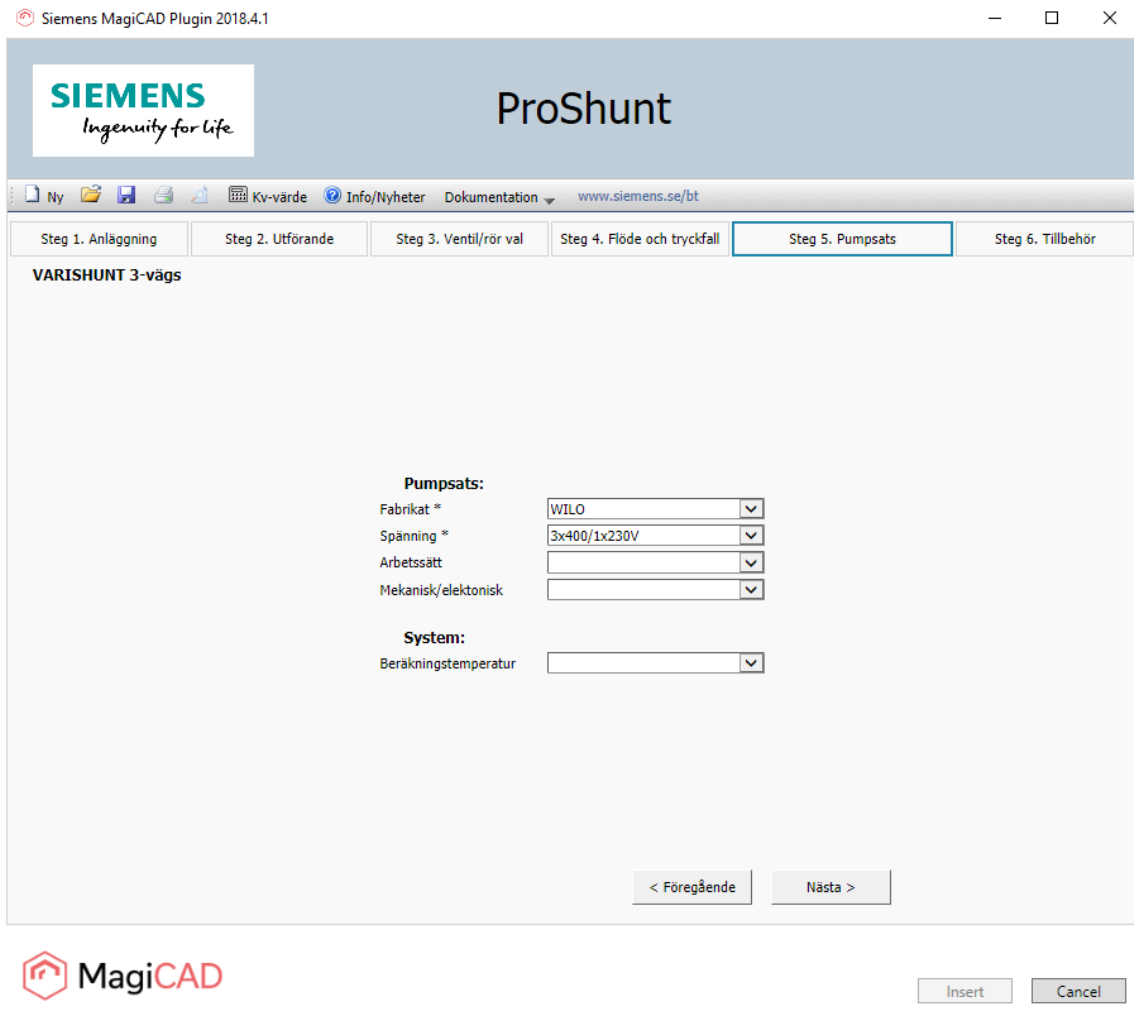

Figure 8 Step 5/6 - Shunt unit pump selection

10. In this step user selects the accessories for the shunt unit and then proceeds to the shunt unit calculation.

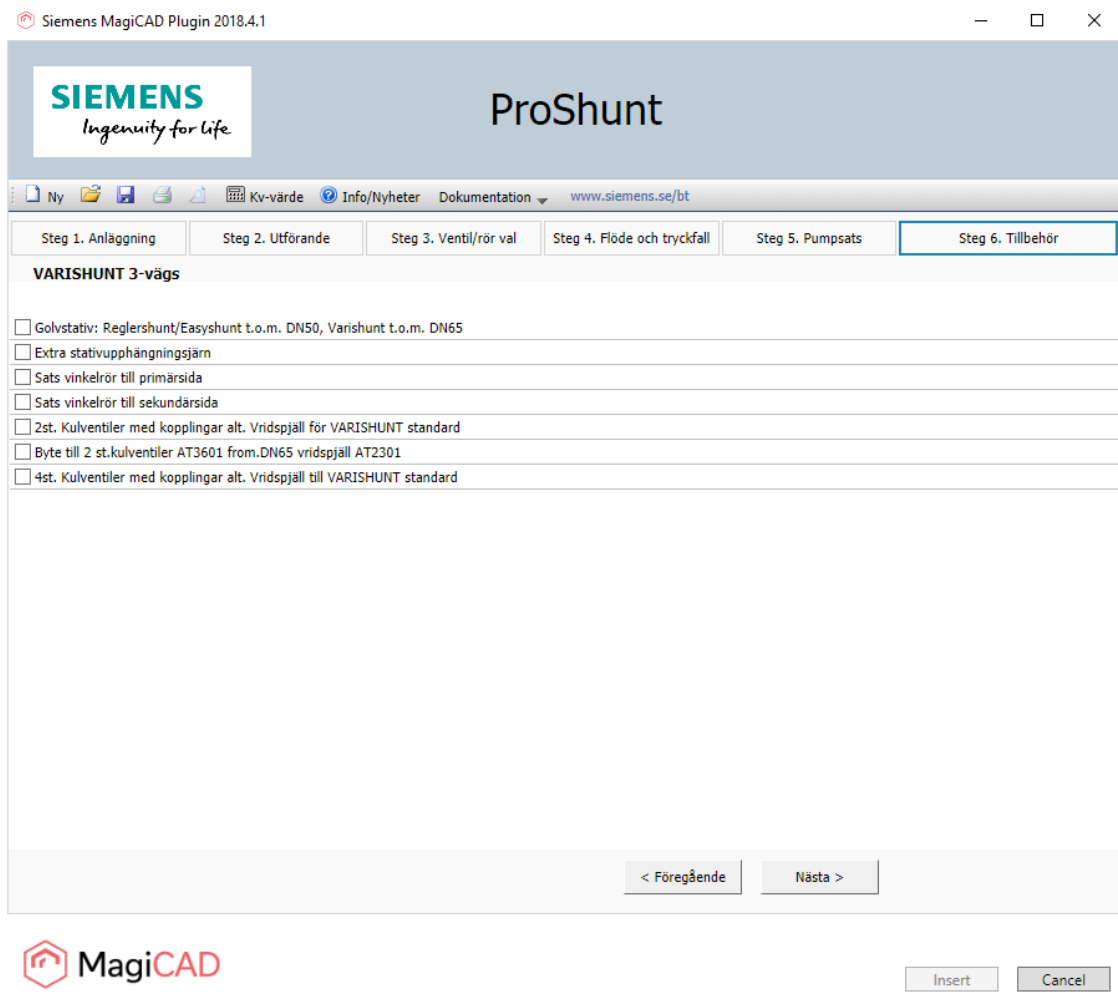

Figure 9 Step 6/6 - Shunt accessories page

11. In final page user sees the plugin input values as well as dimension and calculation results of the shunt unit. User inserts the shunt unit to the MagiCAD project and AutoCAD drawing.

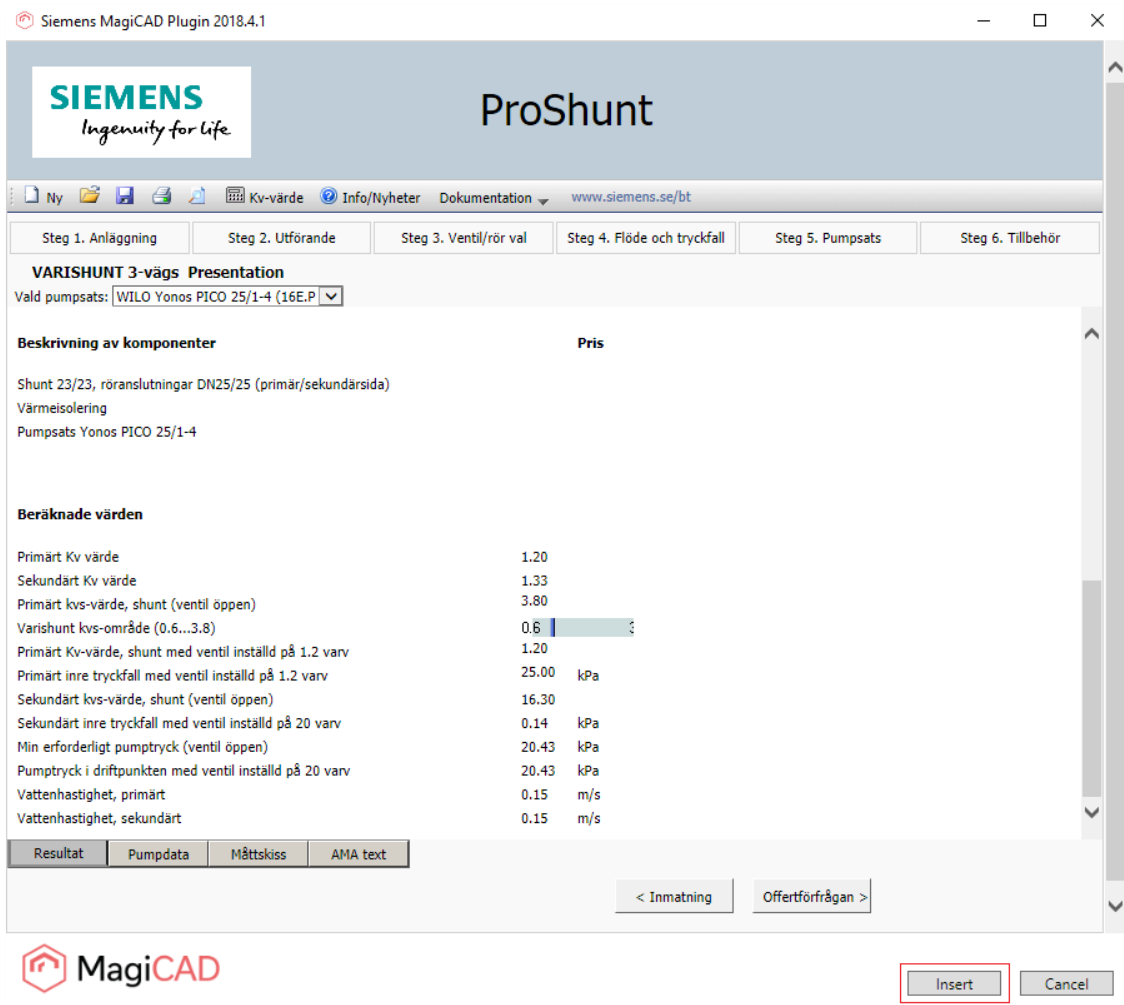

Figure 10 Shunt dimension results page and insert shunt to the MagiCAD project and AutoCAD drawing

12. Shunt unit is inserted to the MagiCAD project and AutoCAD drawing.

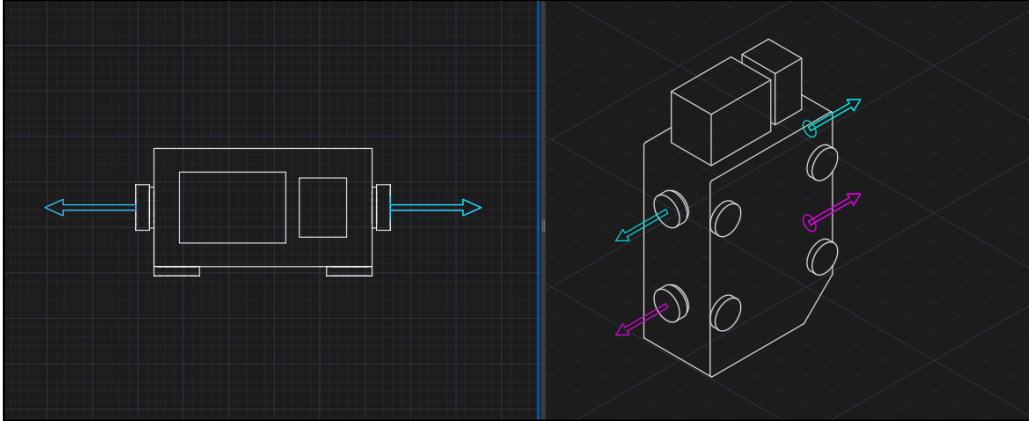

Figure 11 Shunt unit inserted in to MagiCAD project and AutoCAD drawing

13. Finally user connects the shunt unit to the MagiCAD primary and secondary circuits and proceeds to the MagiCAD balancing calculation for the related primary and secondary circuits.

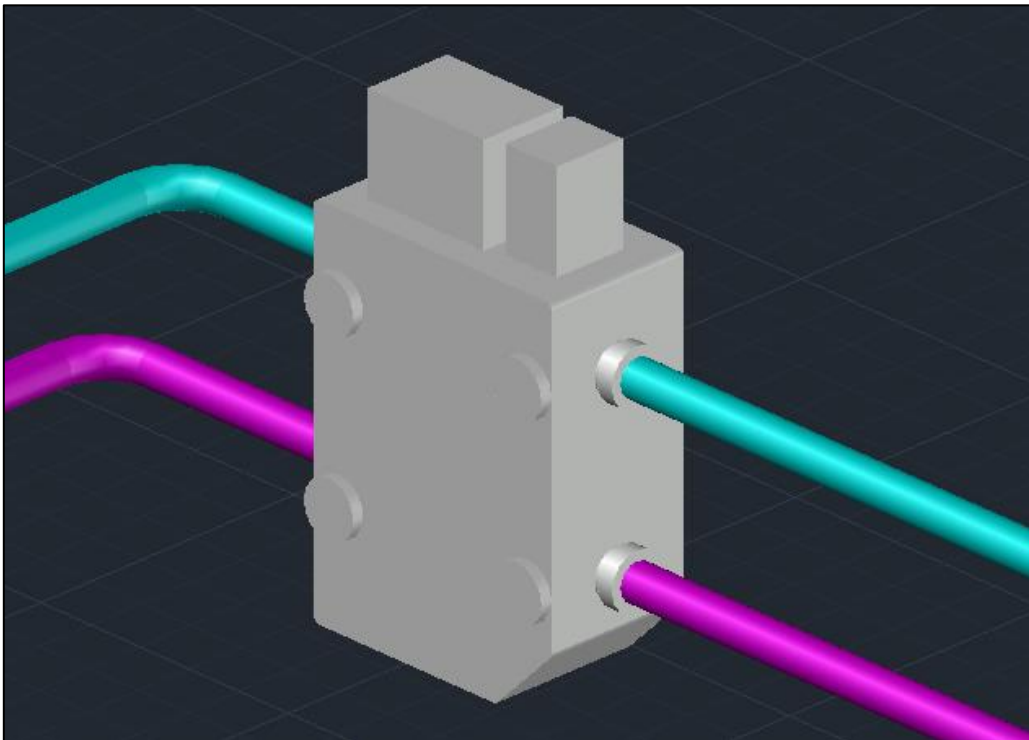
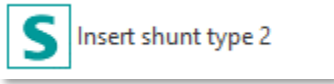

Figure 12 Shunt unit connected to pipework and ready for MagiCAD balancing calculation

Detailed insert operation with Regleshunt and EasyShunt units



Follow these steps to insert Siemens shunt units to AutoCAD drawing:

1. Draw and balance the secondary circuit in MagiCAD. This is important because Siemens MagiCAD plugin sends the secondary circuit flow and pressure drop data to the shunt sizing application. These values are input parameters for unit calculation.
2. Click the “Insert shunt type 2” button from Siemens MagiCAD plugin ribbon panel or give the “SIE_INSERT_REGLERSHUNT_OR_EASYSHUNT” command.
3. Once the operation is started, user is first prompted to select the MagiCAD system for the shunt primary circuit. The selected system will be set for the shunt unit that is exported to the MagiCAD via plugin.

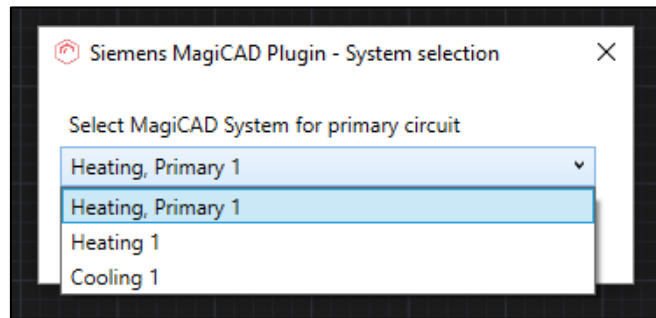

Figure 13 Selecting the primary circuit for the shunt unit

4. User is prompted to select the supply and return pipes of the secondary circuit. It is important to select that part (or near end) of the pipe that should be connected to the shunt unit. Reason for this is that plugin sends flow and pressure drop information data from the selected pipes to shunt sizing application.

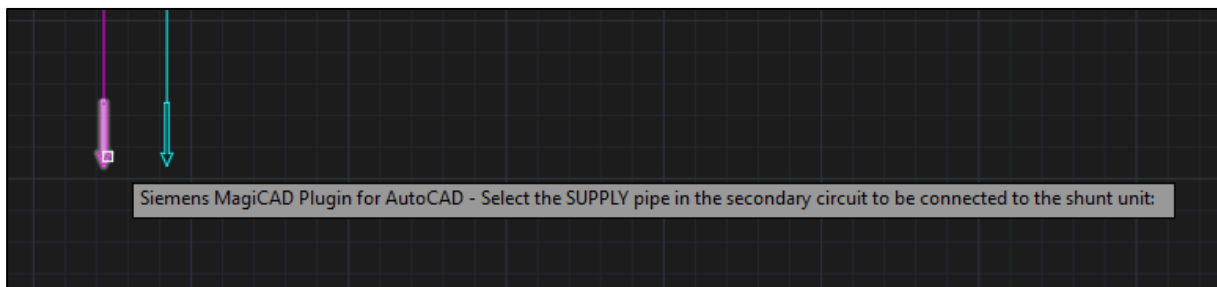

Figure 14 Selecting the supply pipe from the secondary circuit for the shunt unit

- After secondary circuit pipe selections the shunt sizing application is started. In this step user fills the facility information and selects if the unit is for heating or cooling and proceeds to the next step with unit function button.

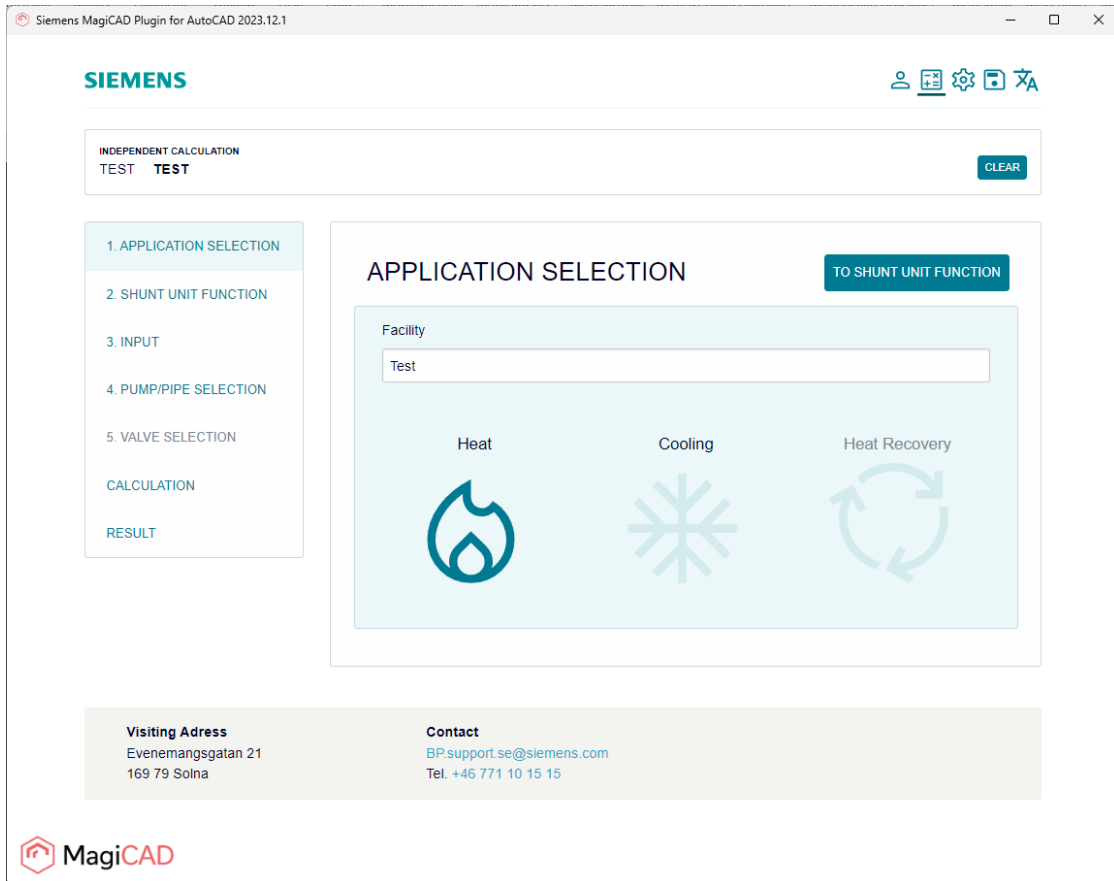

Figure 15 Start the inserting of the Reglershunt or EasyShunt units from sizing application

6. In this step user selects unit function type. Reglershunts are static units and Easyshunt units dynamic. User proceeds to the next step with “To input” button.

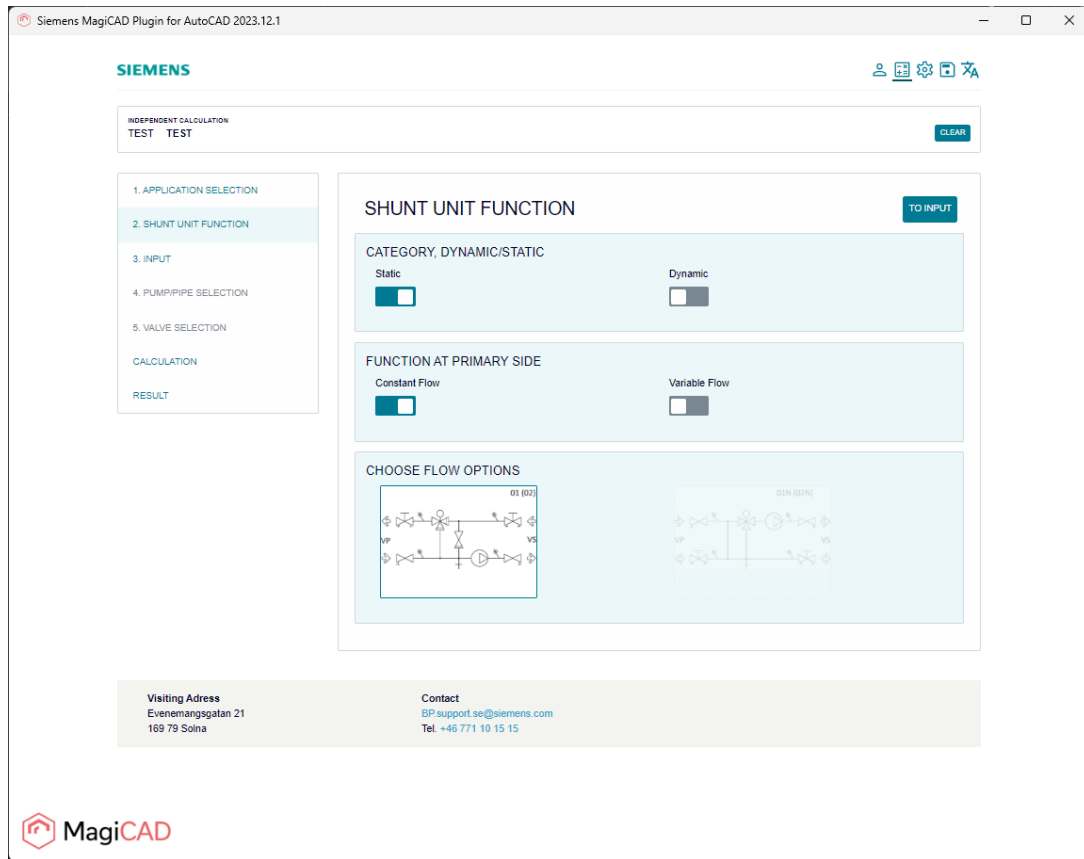
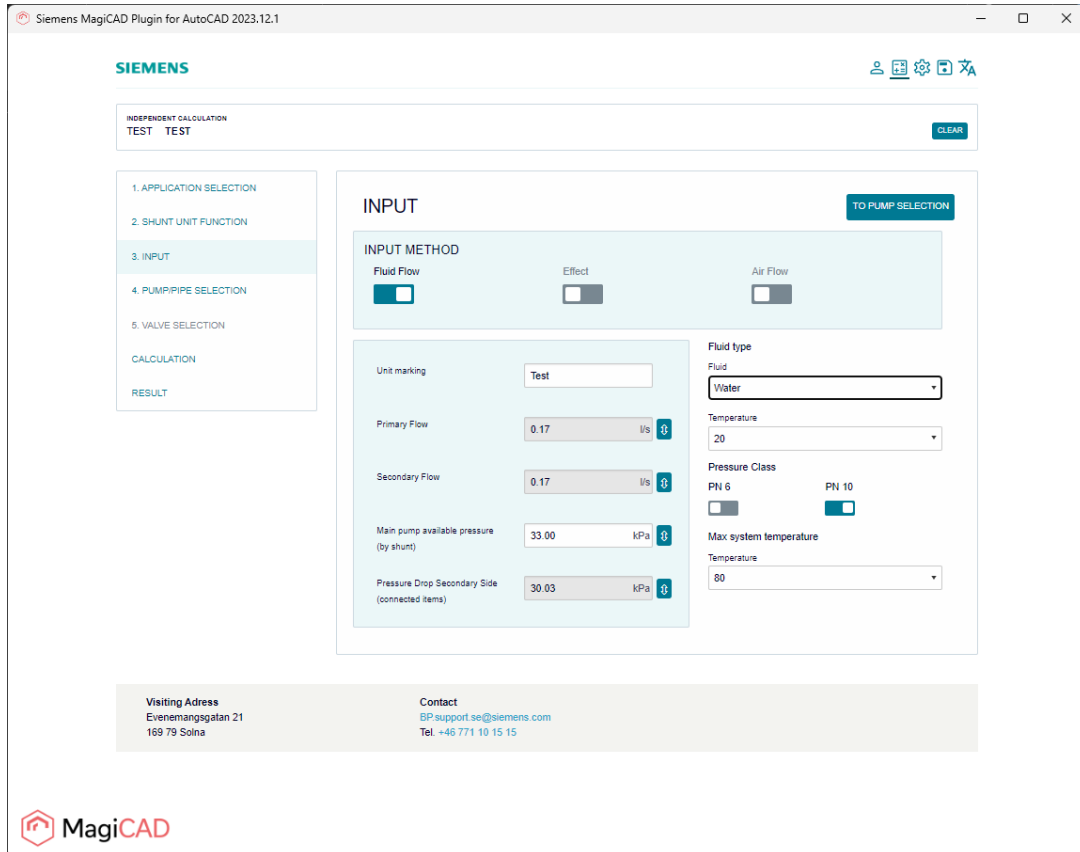

Figure 16 Step 2/6 – Shunt sizing application unit type selection

7. In input step user sets the unit marking, the main pump available pressure and the system fluid type. The driving pressure of the main pump is not available at this point. This is because MagiCAD primary system balancing calculation can't be accomplished before ALL shunt units in the primary circuit have been inserted into it. At this point user needs to input sophisticated guess of the main pumps driving pressure into this field. Proceeds finally to the pump selection.



The screenshot displays the 'INPUT' step of the MagiCAD plugin interface. The window title is 'Siemens MagiCAD Plugin for AutoCAD 2023.12.1'. The interface includes a sidebar with navigation steps: 1. APPLICATION SELECTION, 2. SHUNT UNIT FUNCTION, 3. INPUT (highlighted), 4. PUMPIPE SELECTION, 5. VALVE SELECTION, CALCULATION, and RESULT. The main area is titled 'INPUT' and contains the following fields:

- INDEPENDENT CALCULATION:** TEST TEST (with a CLEAR button)
- INPUT METHOD:** Fluid Flow (checked), Effect (unchecked), Air Flow (unchecked)
- Unit marking:** Text
- Primary Flow:** 0.17 l/s
- Secondary Flow:** 0.17 l/s
- Main pump available pressure (by shunt):** 33.00 kPa
- Pressure Drop Secondary Side (connected items):** 30.03 kPa
- Fluid type:** Water
- Temperature:** 20
- Pressure Class:** PN 6 (unchecked), PN 10 (checked)
- Max system temperature:** 80

At the bottom, there is contact information for Siemens:

Visiting Address: Evenemangsgatan 21, 169 79 Solna
 Contact: BP.support.se@siemens.com, Tel. +46 771 10 15 15

Figure 17 Step 3/6 - Shunt input selection with selected shunt unit

- In this step user selects the shunt unit pump and pipe material and proceeds to unit valve selection.

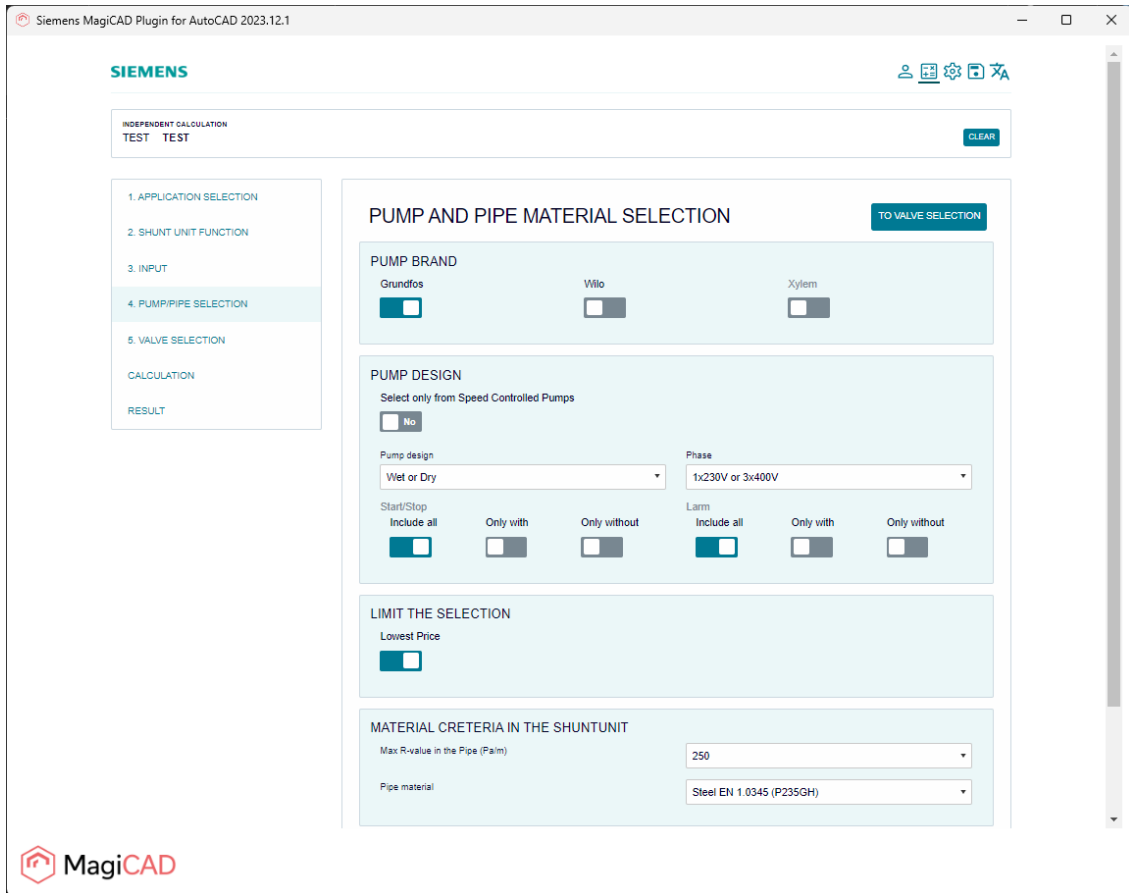

Figure 18 Step 4/6 – Shunt pump and pipe material selection

9. In this step user selects the unit valve and proceeds to the unit calculation.

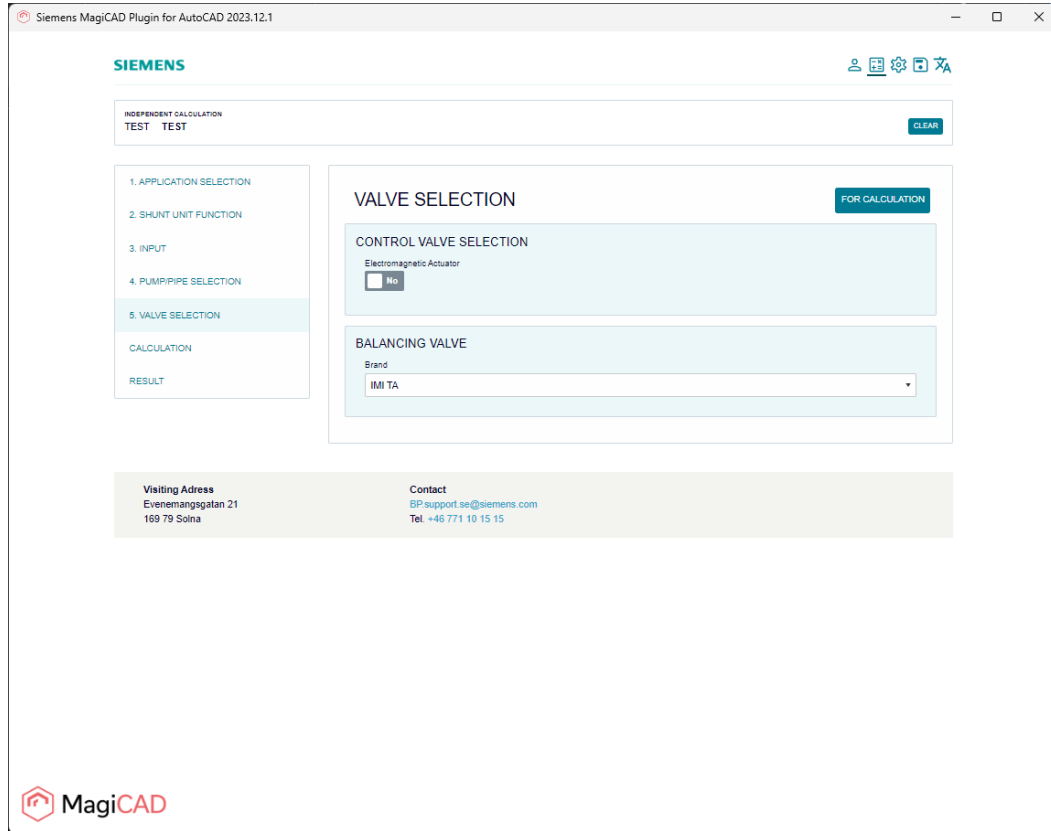

Figure 19 Step 5/6 - Shunt unit valve selection

10. In this step user clicks the calculate button and gets the calculation / sizing result of the unit.

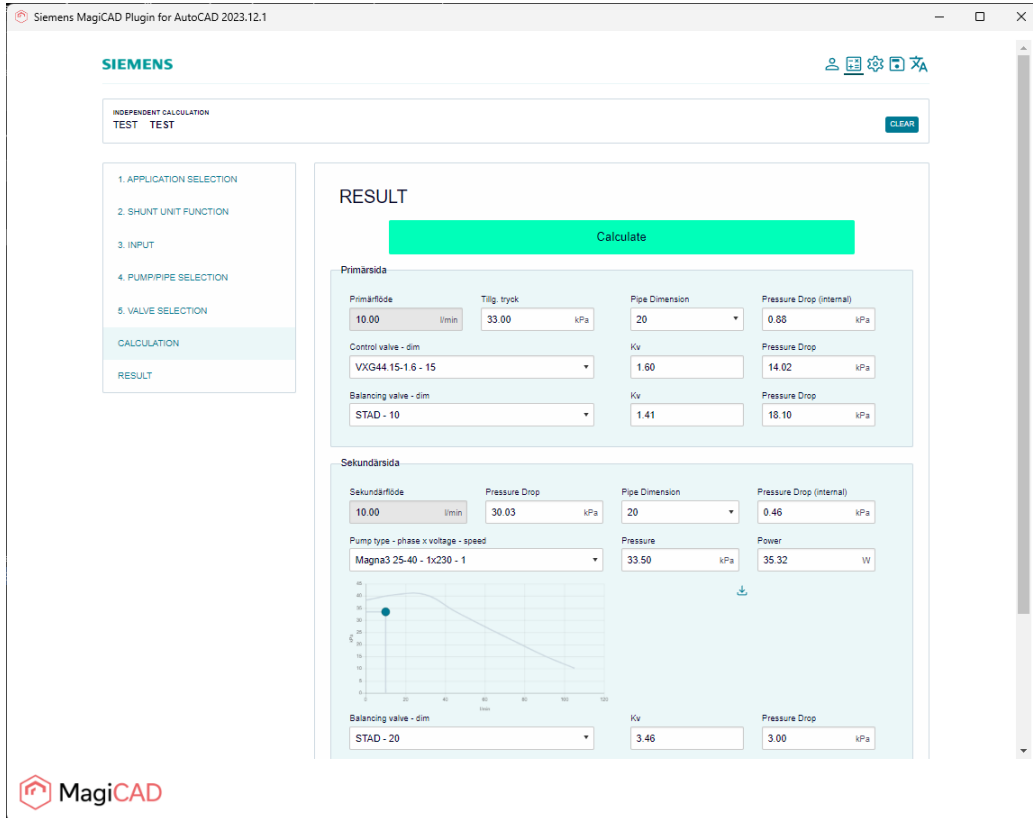

Figure 20 Step 6/6 - Shunt calculation and result page

User proceeds to final result page from “To result” button to see the overall result of the selection and inserts the unit to MagiCAD project and AutoCAD drawing with “Insert to MagiCAD” button.

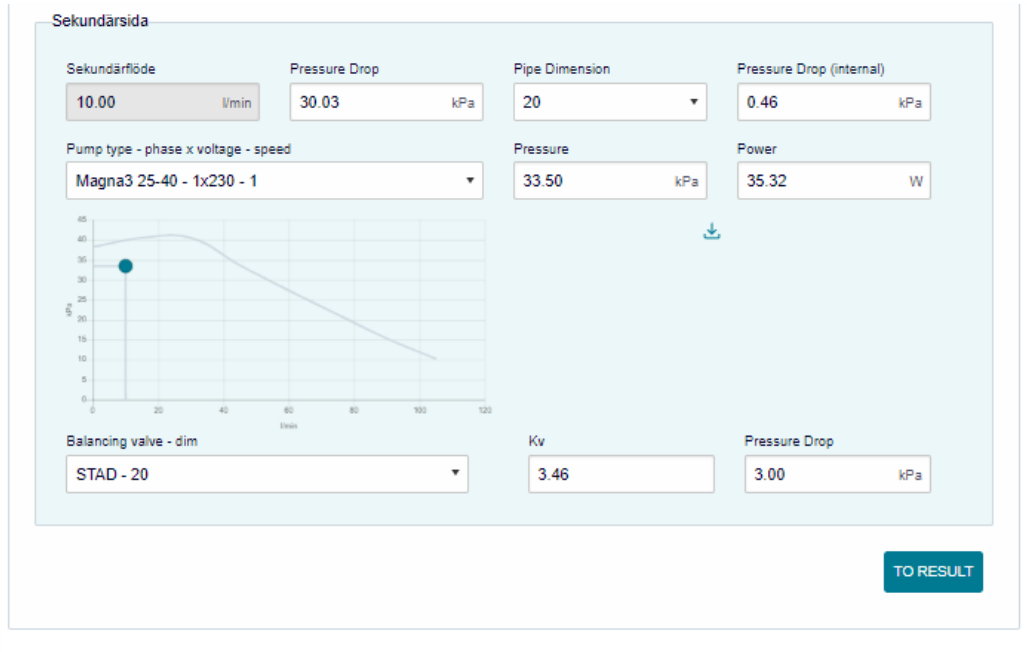

Figure 21 Calculation result page in shunt sizing application

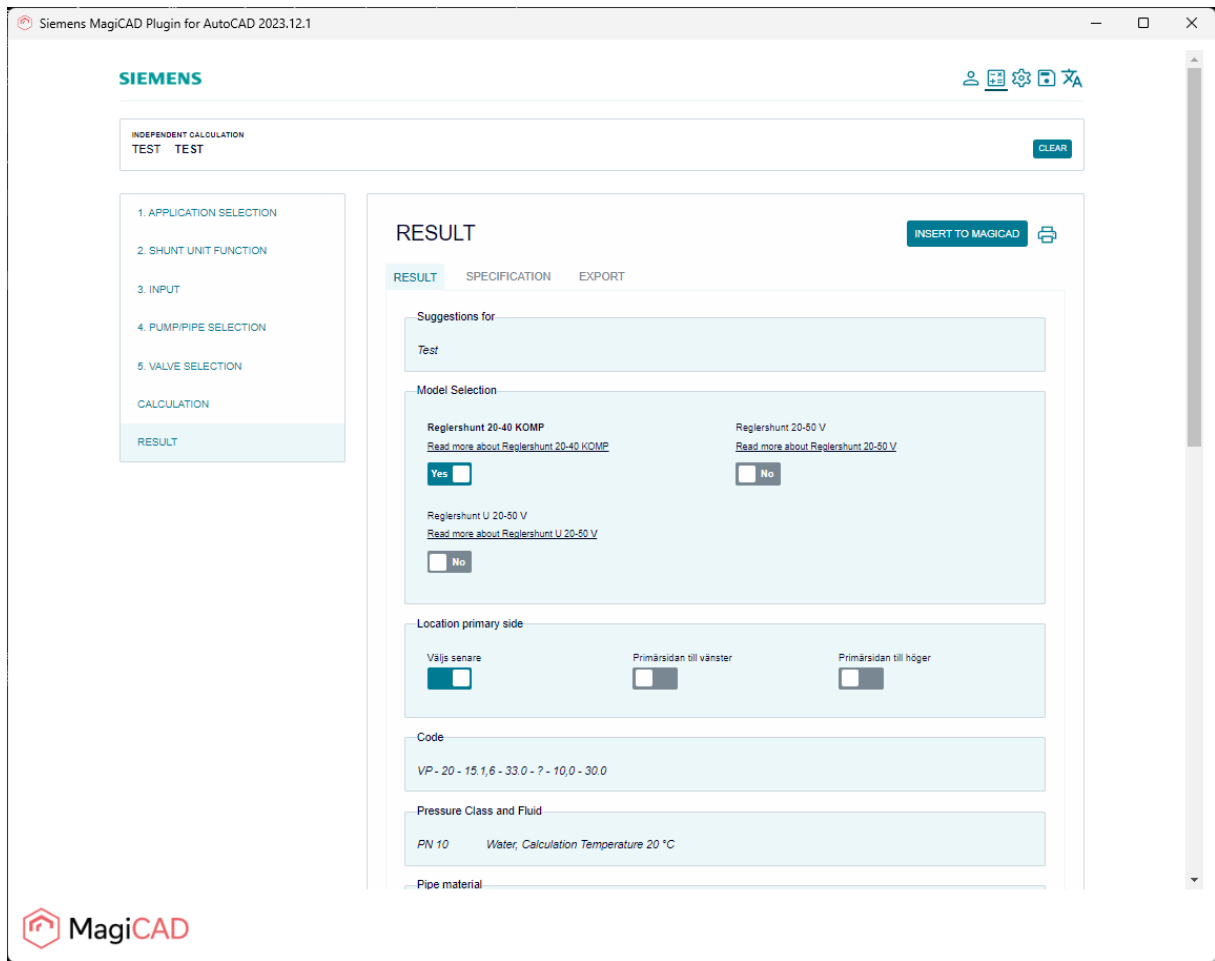

Figure 22 Final result phase in shunt sizing application

11. After “Insert to MagiCAD” button click user is able to drag and drop the unit in AutoCAD drawing.

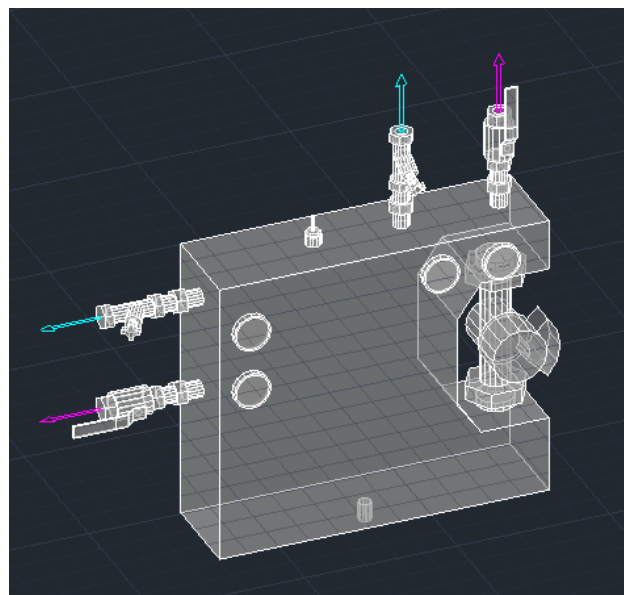
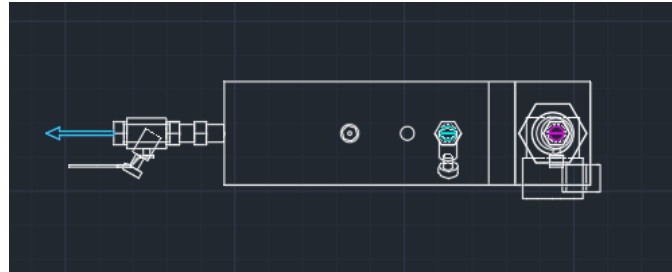

Figure 23 Shunt unit inserted in to AutoCAD drawing and MagiCAD project

12. Finally user connects the shunt unit to the primary and secondary circuits and proceeds to the MagiCAD balancing calculation for the necessary primary and secondary circuits.

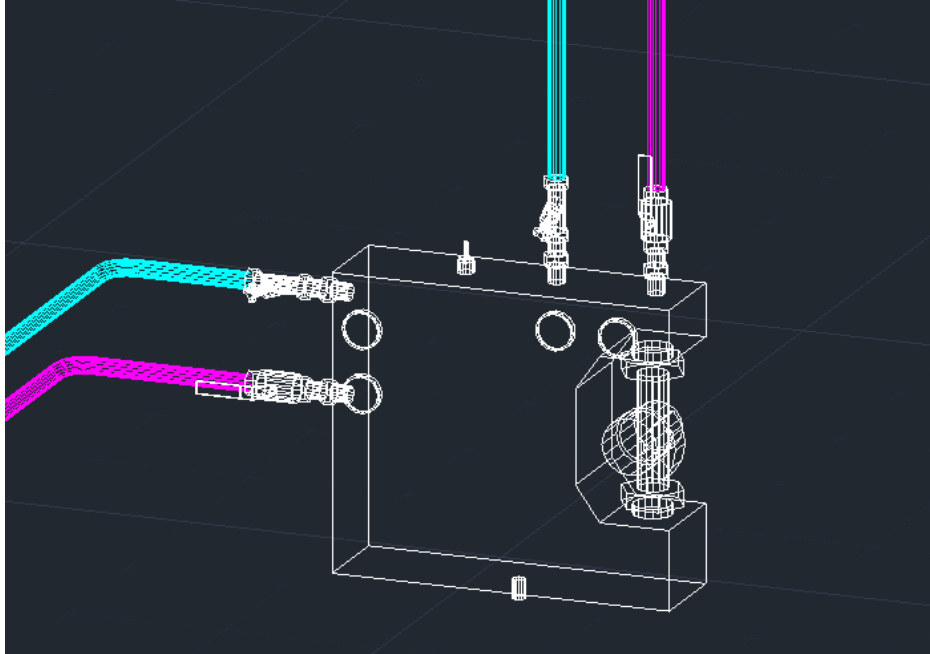
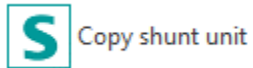

Figure 24 Shunt unit connected to pipework and ready for MagiCAD balancing calculation

Detailed copy operation



The example contains the VARISHUNT unit but same applies for Reglershunt and EasyShunt units.

This operation allows user to copy an existing Siemens shunt unit within the drawing. The copied shunt unit can be pasted single or multiple times into the drawing.

1. Click the “Copy shunt unit” button from Siemens MagiCAD plugin ribbon panel or give the “SIE_COPY” command.
2. User is then asked to select the shunt unit to be copied.

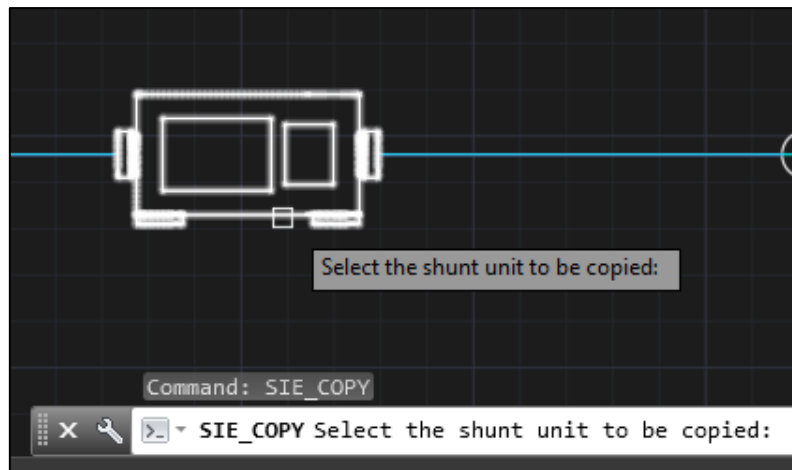
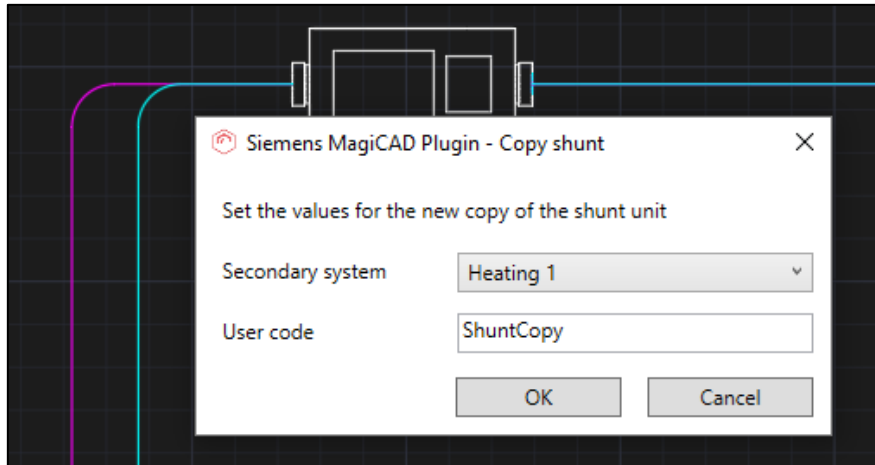

Figure 25 Copy command and prompts for selecting the shunt unit

- After selecting an existing valid shunt unit from the drawing user is prompted with a dialog to select a secondary system for the new shunt unit copy from a dropdown list. Plugin generates a new random user code but user may also write the new user code for the shunt unit.



- After pressing OK user can paste the newly copied shunt unit into the drawing. This is done with the same principle as the insert of the shunt unit after dimension.
- When user has positioned the shunt unit into the drawing, the copy shunt dialog is opened again asking if the user wants to paste another copy of the selected shunt unit. User can add a new copy of the original by filling the required information and pressing OK. This can be repeated multiple times.
- After inserting the last copy of shunt unit user will press cancel from the dialog and connect all the inserted shunt copies to the necessary circuits.

Detailed update operation

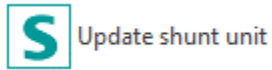

The example contains the VARISHUNT unit but same applies for Reglershunt and EasyShunt units.

Shunt(s) should be updated after the primary circuit is finished. The reason for this is that the shunt sizing calculation application will now get the accurate driving pressure value straight from the MagiCAD instead of an estimation value from the user.

Before updating the shunts make sure that the shunts are connected to the pipework and the MagiCAD balancing calculation has been done for the systems to which the updated shunts are connected to.

After updating the shunts make sure that the shunts are connected to the pipework in case of changed geometry. Run the MagiCAD balancing again to make sure that the pipework and shunts are up to date.

During the shunt unit update operation user can make some changes to shunt unit details like changing the refrigerant, pump details or accessories.

1. Click the “Update shunt unit” button from Siemens MagiCAD plugin ribbon panel or give the “SIE_UPDATE” command.
2. When update shunt unit operation is started, user is first prompted to select the shunt unit to be updated. User selects only one shunt unit for update. In case of need to update multiple shunt units user should use the recalculate operation.

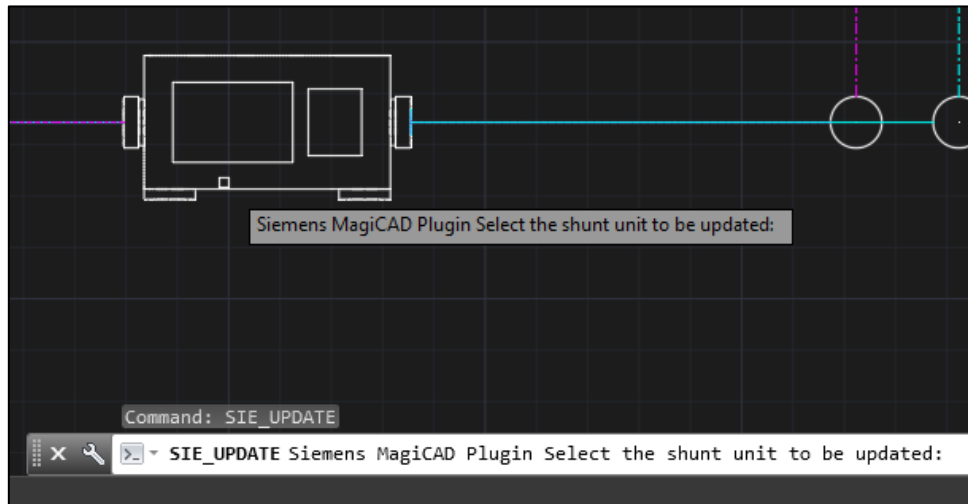

Figure 26 Prompt for selecting the shunt unit for update

3. After the selection is done shunt sizing application is opened and user may do some changes in there. Plugin sends the shunt and circuits data to ProSHUNT dimension program and they can be seen prefilled in the program. Values which are not greyed are user editable values.

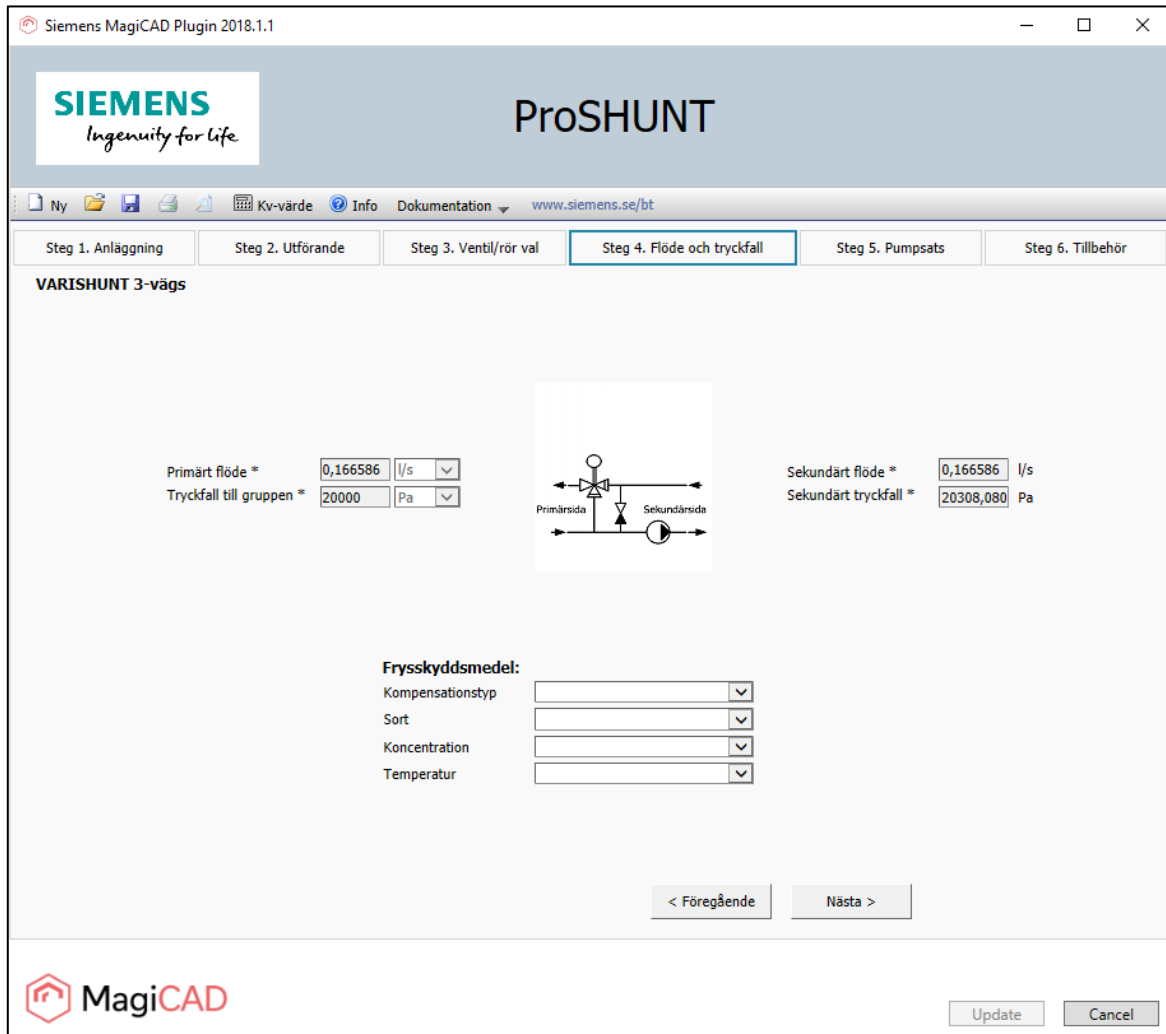

Figure 27 Step 4/6 – Shunt sizing application in VARISHUNT update mode with prefilled values

- After user has gone through the dimensioning and made the needed changes to the shunt unit it can be exported to MagiCAD from final page of the shunt sizing application. User clicks the update button (highlighted with red) to insert the updated shunt unit to MagiCAD.

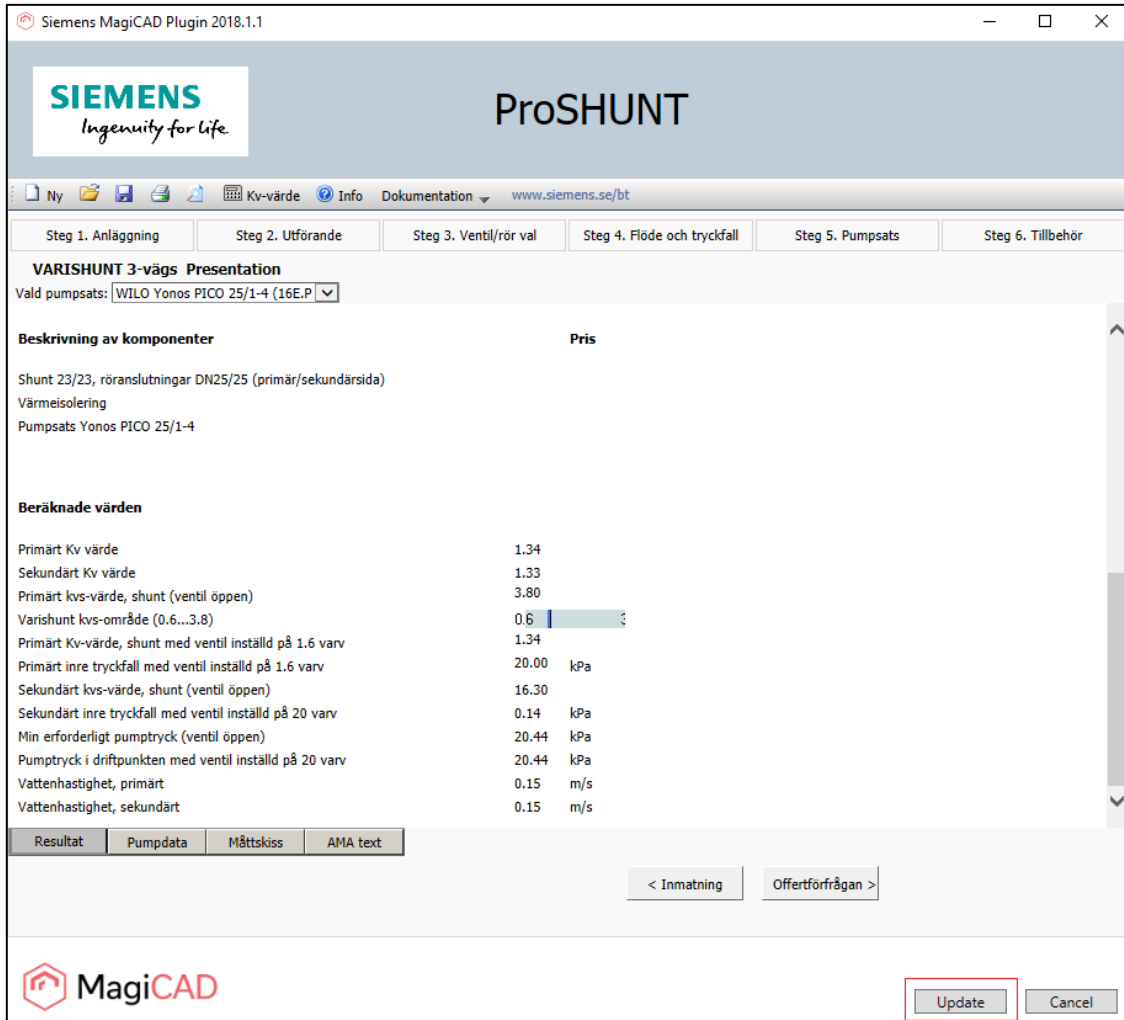

Figure 28 Inserting updated VARISHUNT unit in to MagiCAD

5. After clicking the update button, the dialog informs user that shunt unit has been updated. It also informs if the unit geometry has been changed or not. If the shunt geometry is changed then user should make sure that the shunt is still connected to the circuits intended.

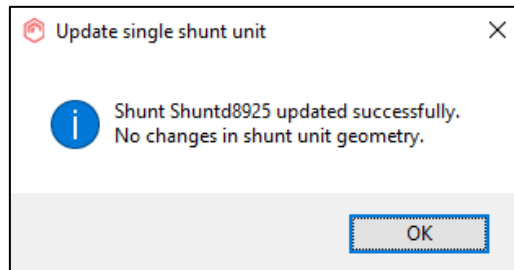
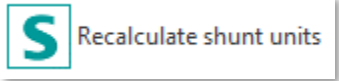

Figure 29 Shunt unit update information dialog

Detailed recalculate operation



Recalculate operation is not available at the moment.

The example contains the VARISHUNT units but same applies for Reglershunt and EasyShunt units.

Shunt(s) should be recalculated after the primary circuit is finished. The reason for this is that the shunt sizing calculation will now get the accurate driving pressure value straight from MagiCAD instead of an estimation from the user. MagiCAD balancing might also give a warning and then user can to use the shunt(s) recalculate operation.

Before recalculating the shunts make sure that the shunts are connected to the pipework and the MagiCAD balancing calculation has been done for the systems to which the shunts are connected to.

After recalculating the shunts make sure that the shunts are connected to the pipework in case of changed geometry. Run the MagiCAD balancing again to make sure that the systems can now be properly balanced.

During the recalculate shunt units operation the user can't make any changes to unit details like changing the refrigerant, pump details or accessories.

1. Click the "Recalculate shunt units" button from Siemens MagiCAD plugin ribbon panel or give the "SIE_RECALC" command.
2. When recalculate shunt units operation is started, user is first prompted to select the shunt units to be recalculated. User may select one or multiple shunt units for recalculation.

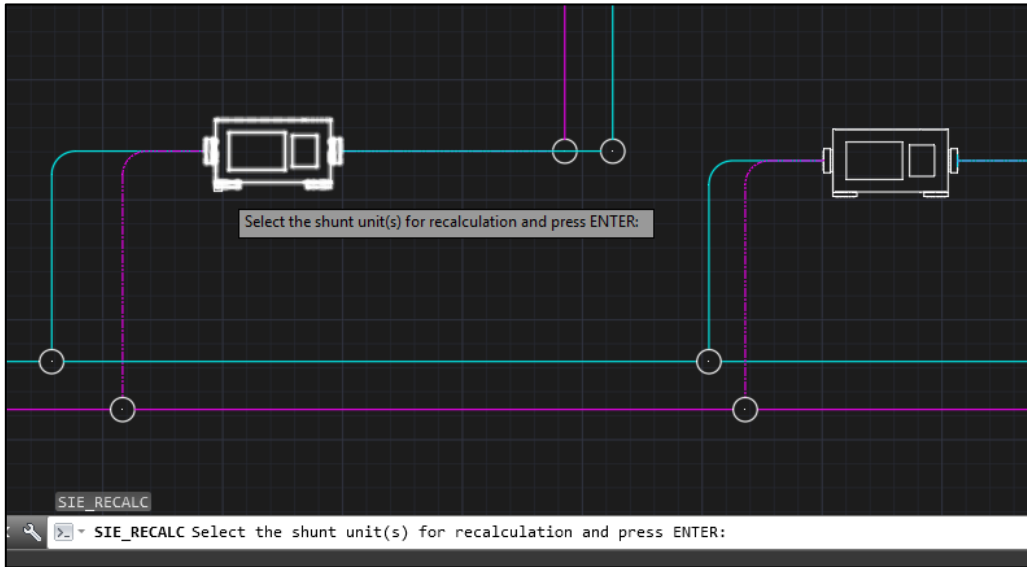

Figure 30 User prompted to select shunt units for recalculation

3. After the selection is done plugin confirms user how many units was selected and sizing application recalculation is called. Plugin sends the shunt(s) data to application and waits for the calculation results.

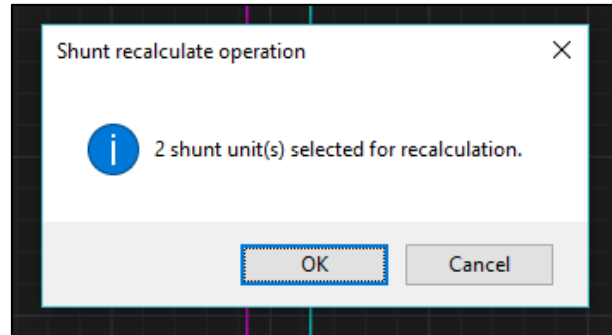

Figure 31 Dialog informing user that how many shunt units selected

- After the recalculation is done plugin shows to user the results of the recalculation: “Calculation status” and the “Operation type” (highlighted in red). Operation type indicates the type of operation which will be made to the shunt unit if user updates the drawing.

If status is “Success” then the operation will be “Unit data update” or “Unit replacement”. In case of “Unit data update” only the data of unit is changed and no geometrical changes are made to the shunt unit. In case of “Unit replacement”, shunt unit data and geometry is changed. In this case user should re-connect the shunt unit to the circuits intended.

If status is error then shunt unit update operation is recommended. Operation column guides user to do that. In update operation user can more easily see what has caused the error in calculation.

User can make a final decision to update the results to drawing or cancel them.

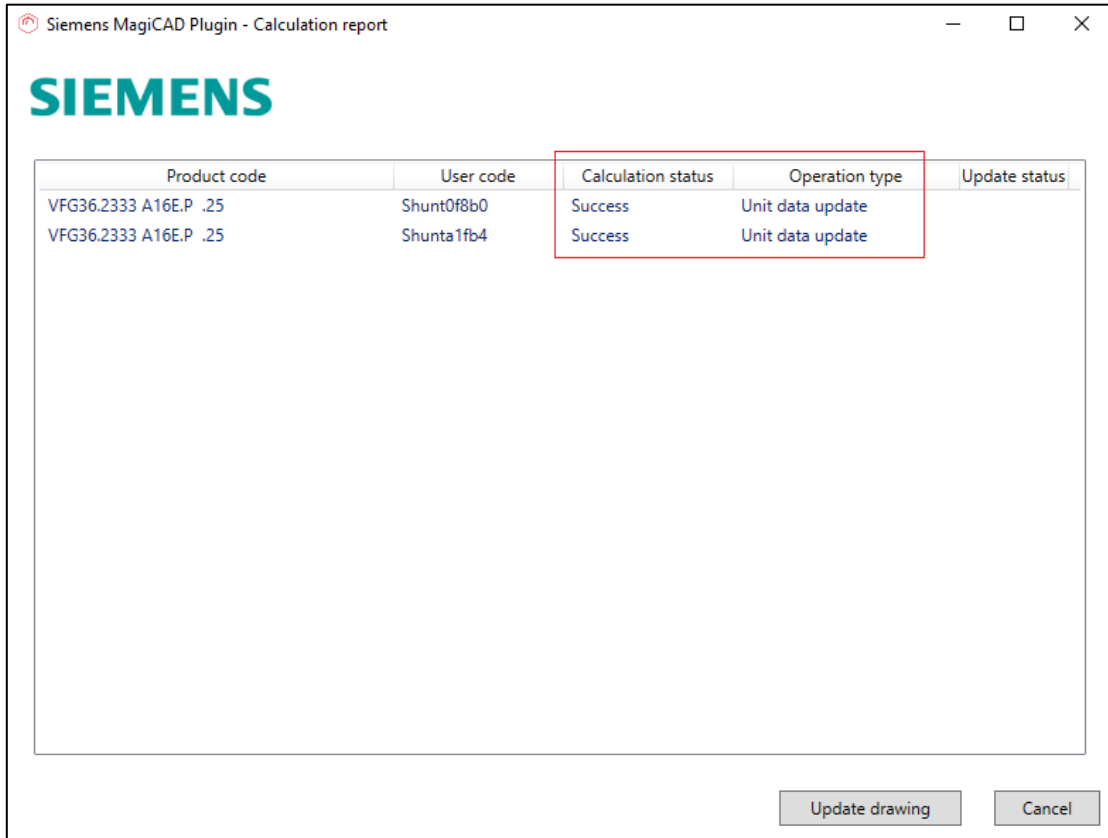

Figure 32 Shunt unit calculation report dialog before units updated to MagiCAD

- When user selects to update the drawing then the results will be shown in the dialog “Update status” column (highlighted in red). If calculation is failed for certain shunt unit then the drawing will not be updated at all by that shunt. The status column stays empty for that shunt.

In case of “Unit data update” operation type “Updated” status will be shown. In case of unit replacement “Replaced” status will be shown.

In case of failure in updating the drawing the “Failed” status is shown.

Close the dialog from OK button.

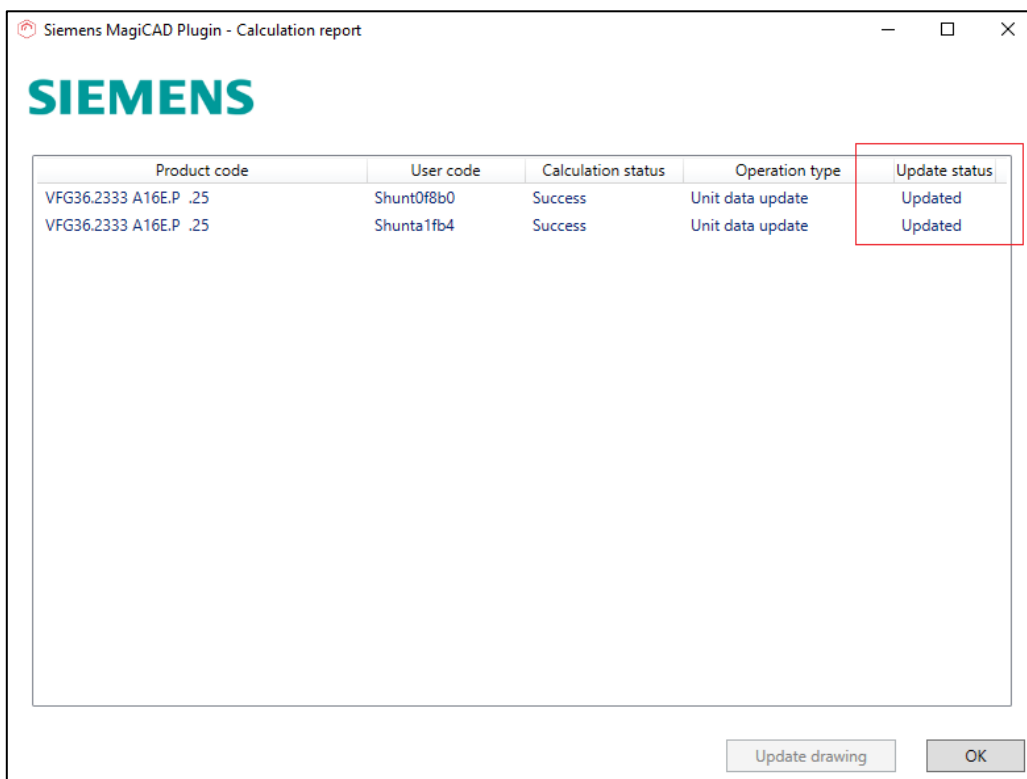
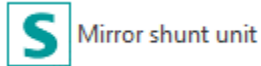

Figure 33 Shunt unit calculation report dialog after units updated to MagiCAD

Detailed mirror operation



The example contains the VARISHUNT unit but same applies for Reglershunt and EasyShunt units.

1. Click the “Mirror shunt unit” button from Siemens MagiCAD plugin ribbon panel or give the “SIE_MIRROR” command.
2. When mirror shunt unit operation is started user is prompted to select the shunt unit which will be mirrored.

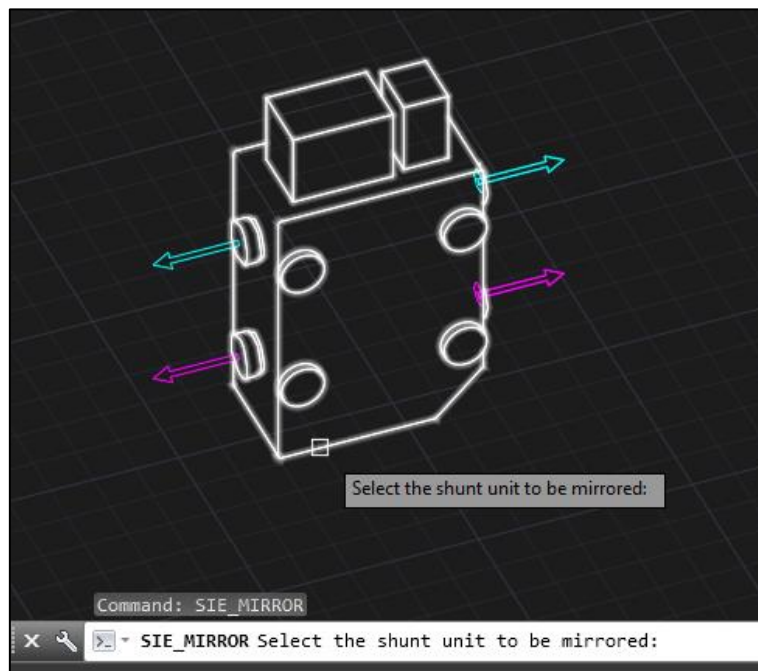

Figure 34 Plugin guides user to select a shunt, which is mirrored

3. After the user selection the shunt unit will be mirrored.

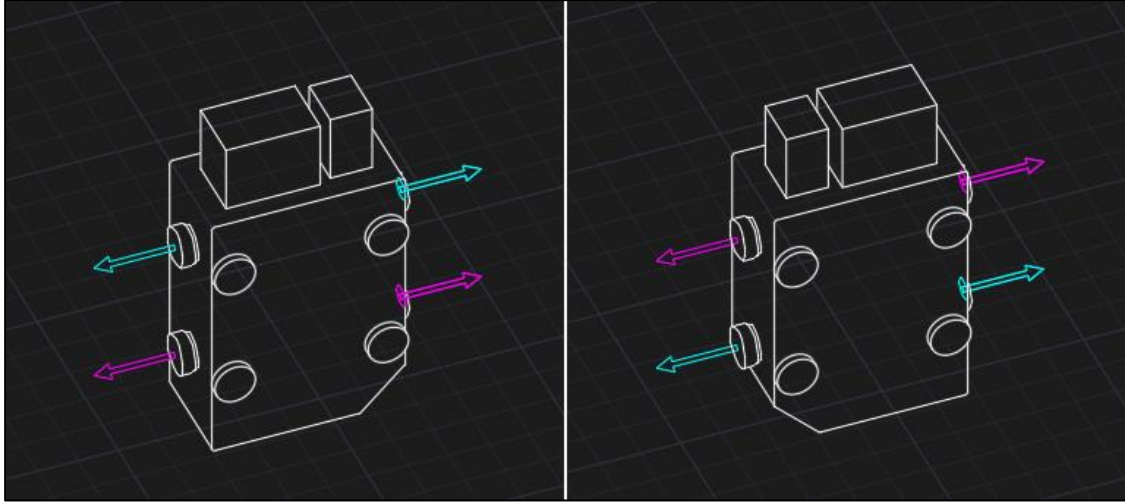
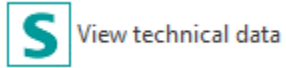

Figure 35 Shunt unit before and after mirroring

Detailed view technical data operation



The example contains the VARISHUNT unit but same applies for Reglershunt and EasyShunt units.

1. Click the “View technical data” button from Siemens MagiCAD plugin ribbon panel or give the “SIE_VIEW” command.
2. When view technical data operation is started user is prompted to select the shunt unit which technical data is wanted to view.

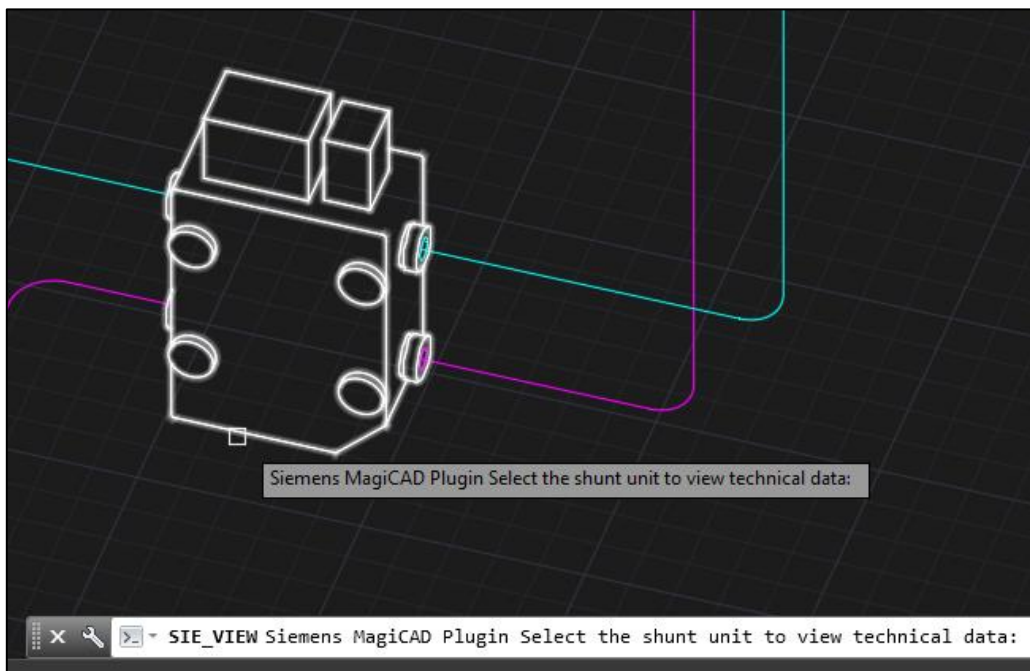

Figure 36 Plugin guides user to select shunt unit which technical data is viewed

3. After the user selection the following dialog will be shown:

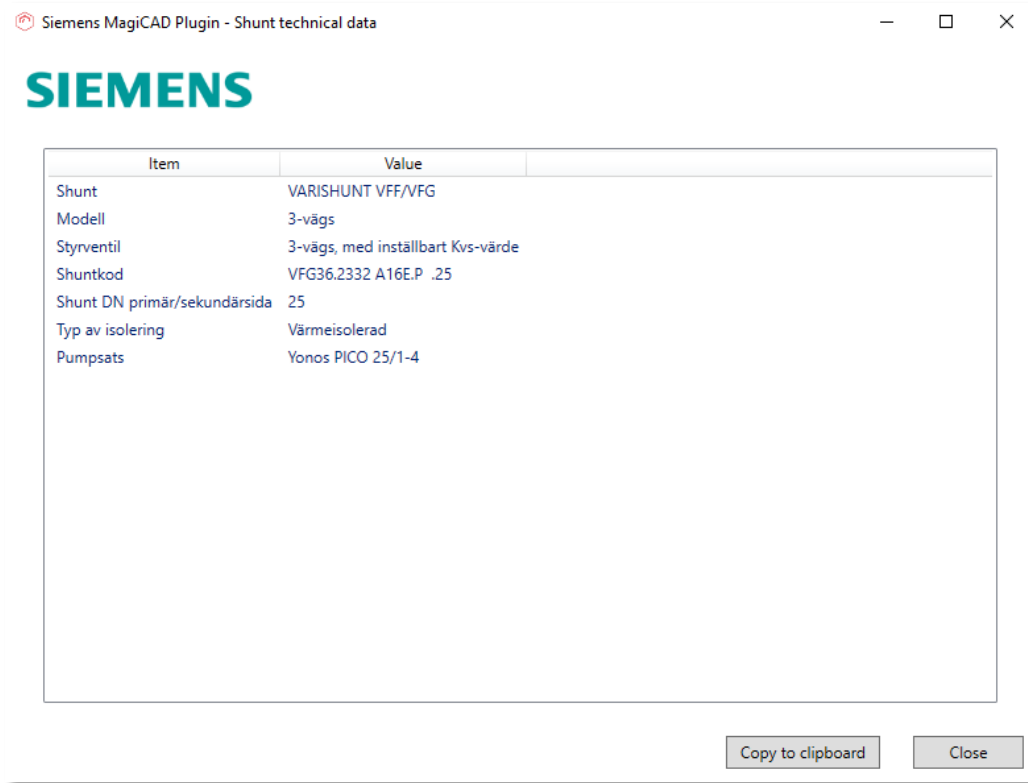

Figure 37 Shunt unit technical data dialog

Copy to clipboard functionality copies the content of the listview to the clipboard. This allows shunt unit technical data transfer to user's own documentation.