



EKOVENT MagiCAD Cloud Plugin for AutoCAD

13/04/2026

Content

1	GENERAL	3
	About this document.....	3
	Installing the software.....	4
	Before the installation.....	4
	Installation.....	4
	Start and using of the application.....	5
2	FUNCTIONS	6
	EKOVENT plugin user interface overview.....	6
	Insert Exhaust function.....	6
	Insert Outdoor Supply function.....	6
	Insert Combination function.....	7
	Detailed Insert Exhaust function.....	8
	Detailed Insert Outdoor Supply function.....	13
	Detailed Insert Combination function.....	18

1 General

About this document

This document contains the instructions for using the EKOVENT MagiCAD plugin with Autodesk AutoCAD application. Plugin application is an add-in application in AutoCAD and requires that MagiCAD is also installed. Plugin application integrates the EKOVENT Roof hood and roof inlet selection tool to AutoCAD and MagiCAD.

With the plugin user can:

- Do the EKOVENT roof hood and inlet product selection with the EKOVENT product selection web application.
- Selection can be done in three different categories for:
 - Exhaust products.
 - Outdoor supply products.
 - Combination products with exhaust and outdoor supply connections.
- Insert the selected product into MagiCAD project and AutoCAD drawing.

After insert operation, user will attach the inserted product into MagiCAD ventilation ductwork and is able to see the technical data of the products and see the product related results of the MagiCAD specific calculations.

Note that plugin will check that the operation and product specific MagiCAD systems (ventilation outdoor supply / exhaust) are available in MagiCAD project. If the systems are missing, user is informed about that. User can still view the products in the EKOVENT product selection even the insert operation is not possible.

Installing the software

EKOVENT MagiCAD plugin for AutoCAD supports the following MagiCAD and AutoCAD versions:

- MagiCAD 2026 and AutoCAD 2023-2026
- MagiCAD 2027 and AutoCAD 2023-2027

Before the installation

1. Workstation administrator privileges are recommended for installation.
2. **Notice if you have several AutoCAD versions on your workstation.**
Before running the plugin installer, start MagiCAD to make sure that EKOVENT MagiCAD Plugin for AutoCAD installs on the same AutoCAD platform version where MagiCAD is installed.

Installation

1. Download the plugin installer file from MagiCAD portal to your workstation:
<https://portal.magicad.com/Download/ProductSearch?searchStr=EKOVENT&categoryId=3>
2. Run the EKOVENT MagiCAD for AutoCAD plugin installer on your workstation and follow the instructions in installer.

Start and using of the application

The plugin is automatically loaded and is ready to be used once MagiCAD and AutoCAD is started next time after the plugin installation.

Before you start using the EKOVENT plugin, create or open a MagiCAD ventilation project in AutoCAD. All the necessary ventilation systems should be available in the project.

Locate the MagiCAD Connect tab from the AutoCAD ribbon. Once the EKOVENT plugin is loaded, the EKOVENT ribbon panel and split button can be found from MagiCAD Connect tab. Split button contains separate buttons for different functions: “Insert Exhaust”, “Insert Outdoor Supply” and “Insert Combination”.

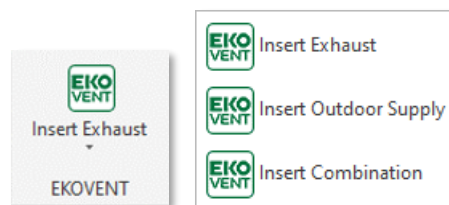

Figure 1 EKOVENT panel and split button functions

2 Functions

EKOVENT plugin user interface overview

EKOVENT plugin contains three different functions with buttons in the AutoCAD UI. Buttons exist in the MagiCAD plugin tab and EKOVENT specific panel.

Insert Exhaust function



With this command, user can select the roof hood products for exhaust systems from EKOVENT selection tool web application. In addition, user can select also a suitable roof inlet for the roof hood.

After the selection, user can insert the selected product(s) into MagiCAD project and AutoCAD drawing as a 3D geometry object which contains all the HVAC specific data offered by EKOVENT selection tool.

For more information see chapter *Detailed Insert Exhaust function*.

Insert Outdoor Supply function



With this command, user can select the roof hood products for outdoor supply systems from EKOVENT selection tool web application. In addition, user can select also a suitable roof inlet for the roof hood.

After the selection, user can insert the selected product(s) into MagiCAD project and AutoCAD drawing as a 3D geometry object which contains all the HVAC specific data.

For more information see chapter *Detailed Insert Outdoor Supply function*.

Insert Combination function

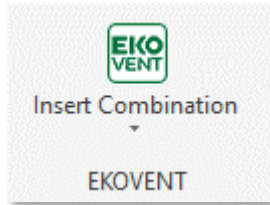

With this command, user can select the combination roof hood products for exhaust and outdoor supply systems from EKOVENT selection tool web application. In addition, user can select also a suitable roof inlet for the roof hood.

After the selection, user can insert the selected product(s) into MagiCAD project and AutoCAD drawing as a 3D geometry object which contains all the HVAC specific data.

For more information see chapter *Detailed Insert Combination function*.

Detailed Insert Exhaust function

Pre-requirement for inserting the exhaust type roof hoods and inlets is to have the MagiCAD project with at least one exhaust system. Without the system, user can view the products in EKOVENT selection tool with plugin but insert function is not available. If the required system is missing, plugin will inform user about this with a specific dialog.

Follow these steps to insert the roof hood and inlet products to AutoCAD drawing and MagiCAD project.

1. Start the insert operation from EKOVENT panel button or type the command **EKOVENT_INS_EXH**.
2. If MagiCAD project contains the required exhaust system, the EKOVENT selection tool is opened in plugin and all the exhaust type roof hoods and suitable inlets are available for selection. User can filter the products with technical data or select a specific product.

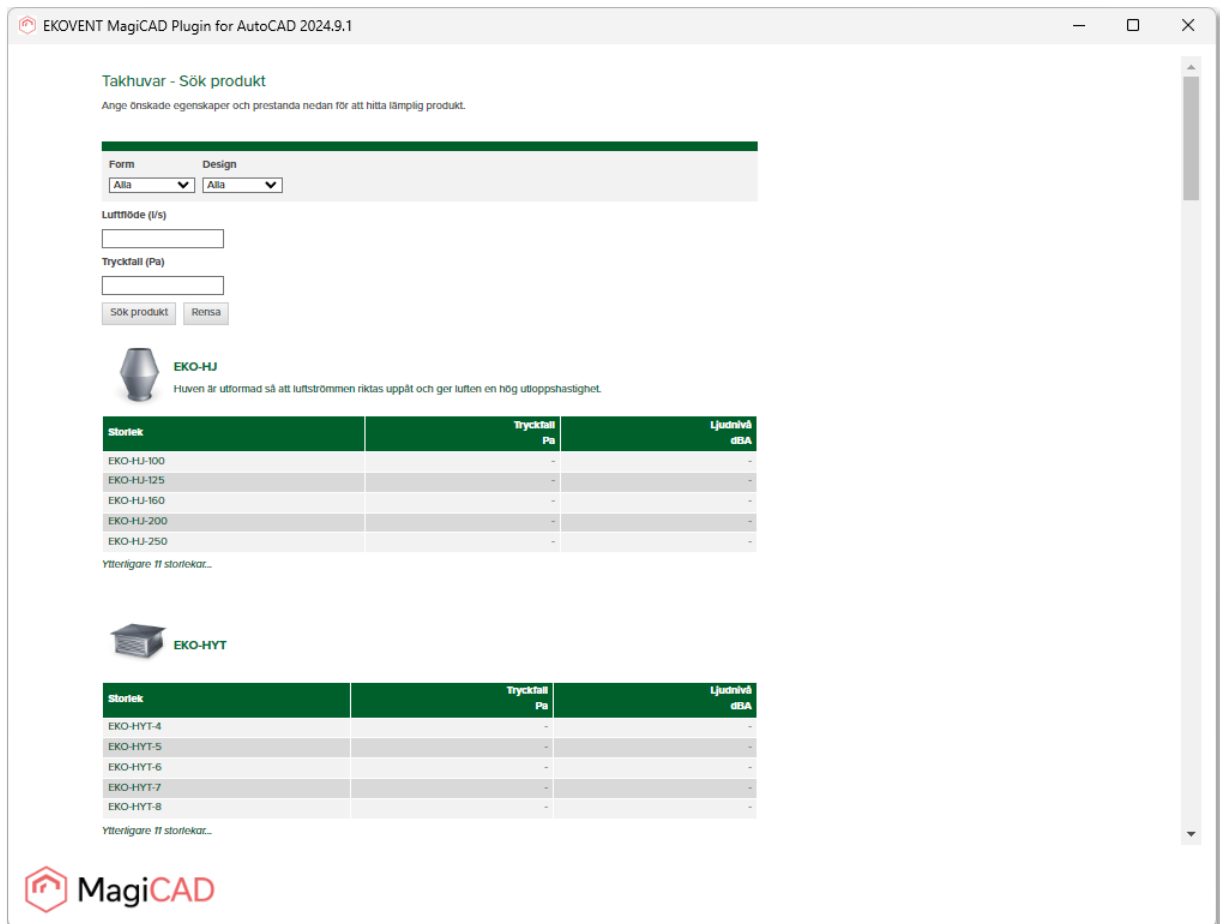
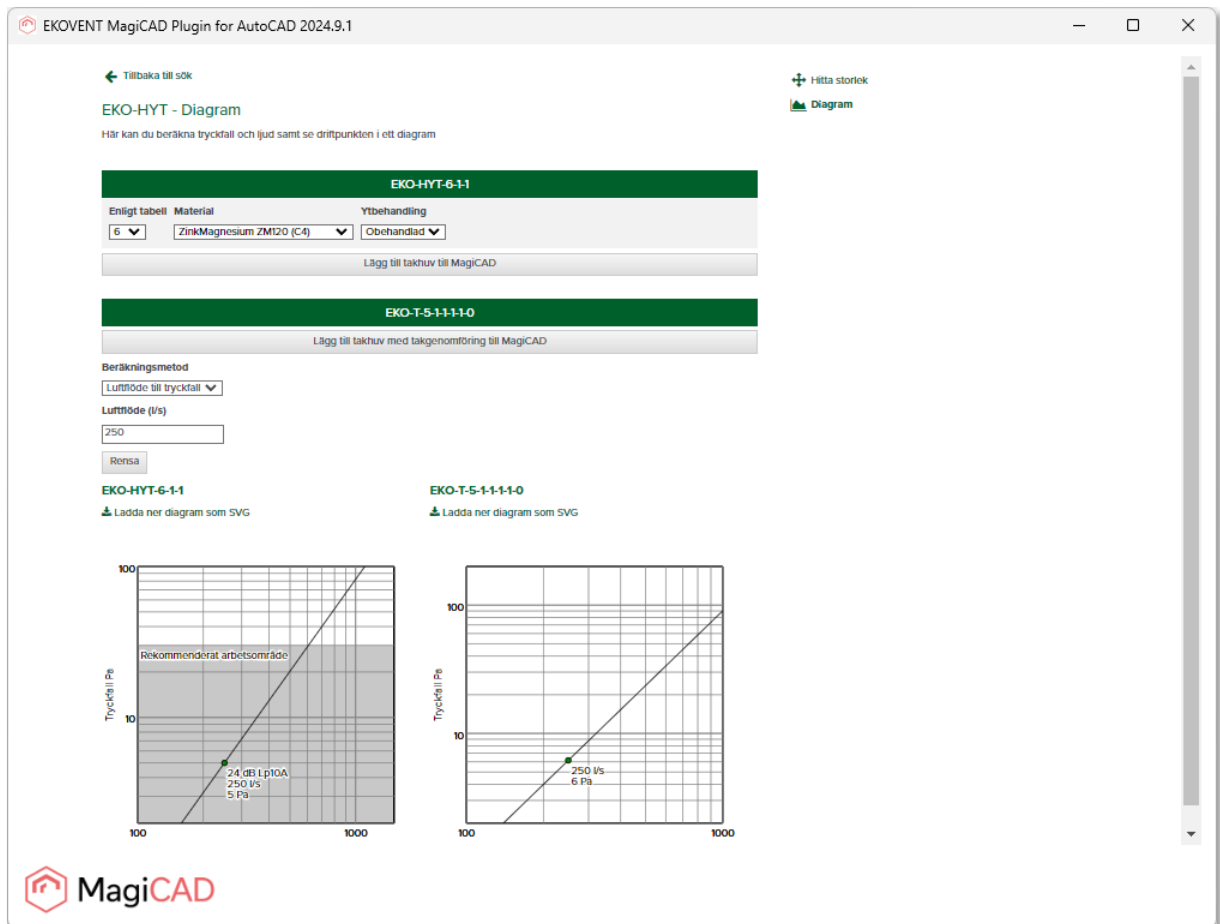

Figure 2 EKOVENT Selection tool with exhaust roof hoods

- After the desired product family and variant is selected, user can see the product variant specific data according to given air flow value. Finally, user starts the insert function of the roof hood or the combination of roof hood and inlet from dedicated button in selection tool.



The screenshot displays the EKOVENT MagiCAD Plugin for AutoCAD 2024.9.1 interface. It features a navigation bar with 'Tillbaka till sök' and 'Hitta storlek' options. The main area is titled 'EKO-HYT - Diagram' and includes instructions: 'Här kan du beräkna tryckfall och ljud samt se driftpunkten i ett diagram'. Below this, there are two product selection sections:

- EKO-HYT-6-1-1**: Includes a table with columns 'Enligt tabell', 'Material', and 'Ytbehandling'. The selected values are '6', 'ZinkMagnesium ZM120 (C4)', and 'Obehandlad'. A button below reads 'Lägg till takhuv till MagiCAD'.
- EKO-T-5-1-1-1-0**: Includes a button that reads 'Lägg till takhuv med takgenomföring till MagiCAD'.

Below the product sections, there is a 'Beräkningsmetod' section with a dropdown menu set to 'Luftflöde till tryckfall'. The 'Luftflöde (l/s)' input field is set to '250', and there is a 'Rensa' button. Two product-specific sections are visible:

- EKO-HYT-6-1-1**: 'Ladda ner diagram som SVG' button.
- EKO-T-5-1-1-1-0**: 'Ladda ner diagram som SVG' button.

At the bottom, there are two log-log plots showing 'Tryckfall Pa' (Pressure Drop) on the y-axis (ranging from 10 to 100) versus an unlabeled x-axis (ranging from 100 to 1000). The left plot shows a shaded 'Rekommenderat arbetsområde' (Recommended operating range) and a data point at '24 dB Lp10A', '250 l/s', and '5 Pa'. The right plot shows a data point at '250 l/s' and '6 Pa'. The MagiCAD logo is visible in the bottom left corner.

Figure 3 EKOVENT Selection tool with product view

4. Next plugin shows the Insert roof hood dialog where user can:
 - See the product codes of the selected products.
 - Change the plugin generated user code for roof hood.
 - Change the offset (product height level) values for roof hood.
 - Change the inlet user code, if inlet was selected.
 - Change the offset values for inlet, if inlet was selected.
 - Select the exhaust ventilation system and air flow.

Insert function is finalized with insert button.

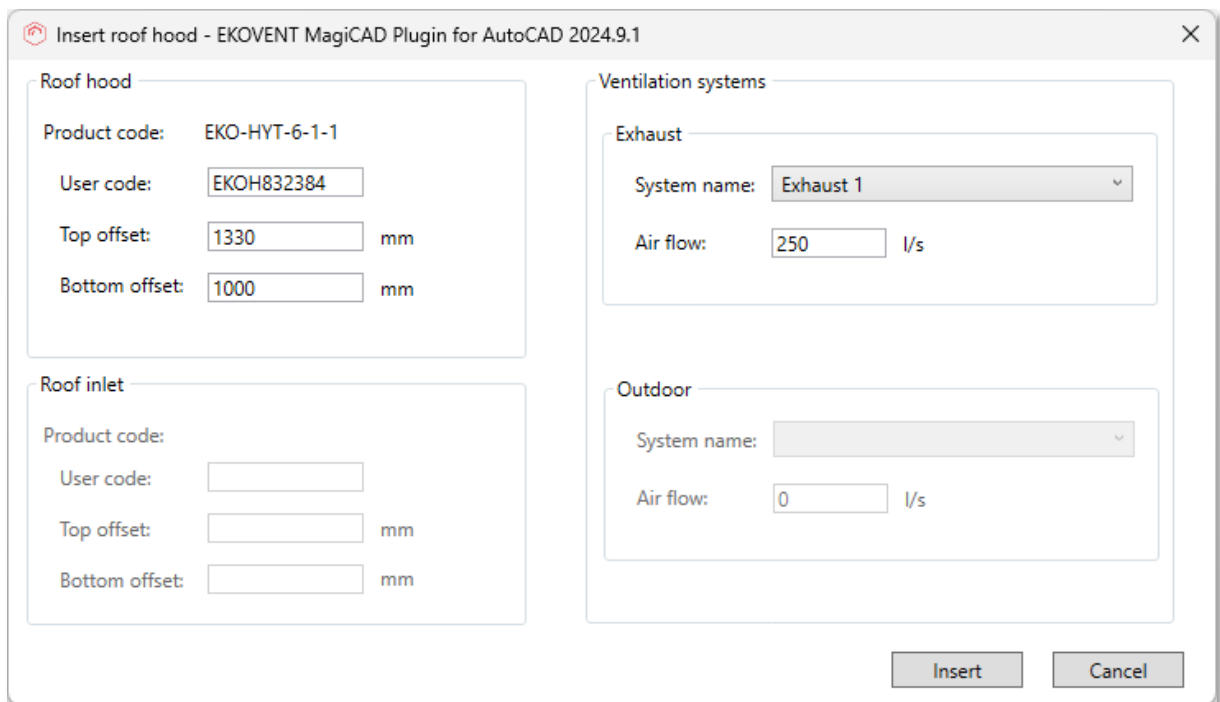

Figure 4 EKOVENT plugin dialog with exhaust product

5. Finally, user is able to drag and drop the 3D geometry object in the AutoCAD drawing and rotate the product. Product is connected to exhaust ventilation ductwork with its bottom connector.

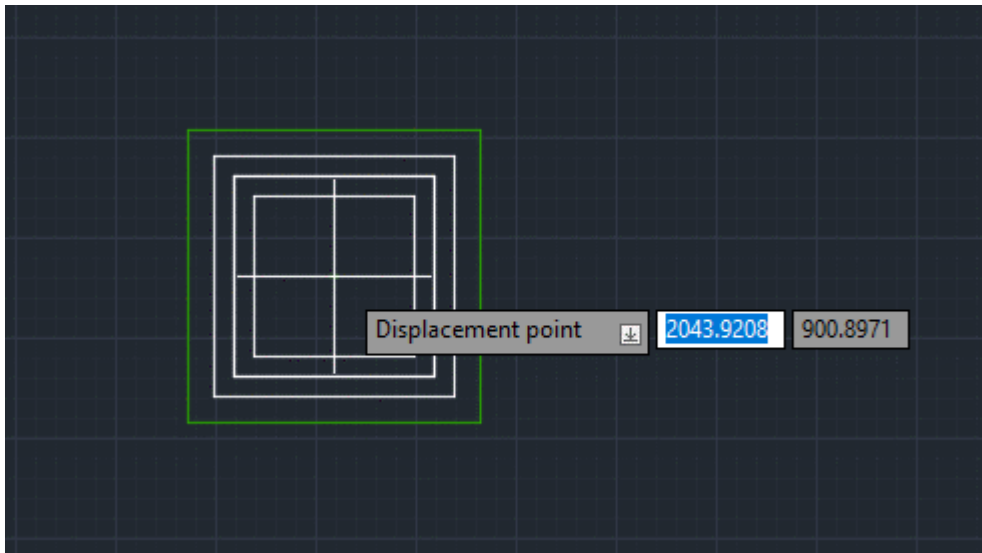

Figure 5 Exhaust roof hood product placement in AutoCAD drawing

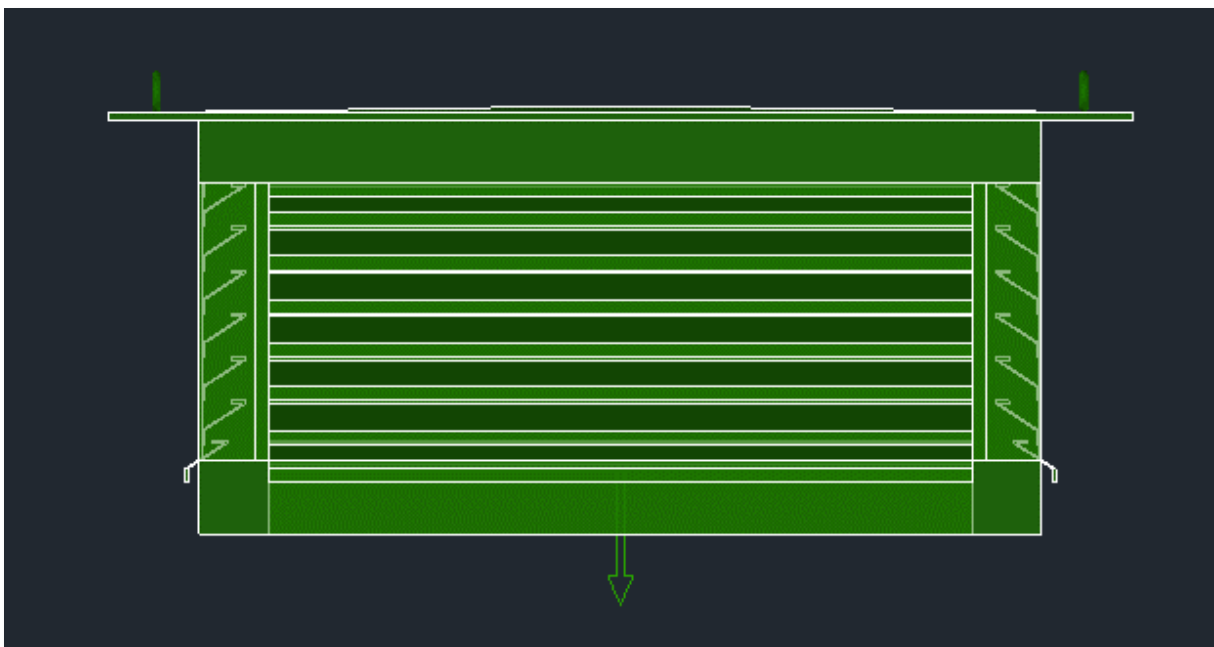

Figure 6 Exhaust roof hood product 3D geometry in AutoCAD drawing

- Product specific technical data is visible in the MagiCAD part properties dialog and also in MagiCAD ductwork balancing report after the balancing calculation is run.

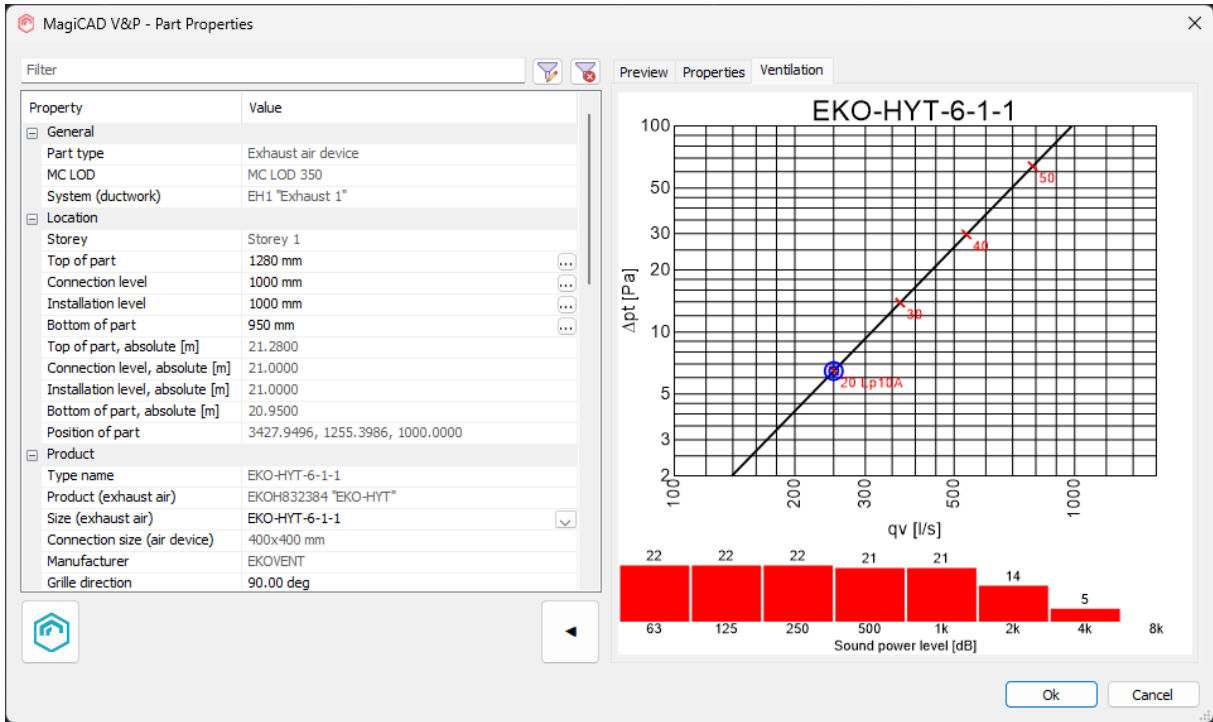

Figure 7 MagiCAD Part properties dialog

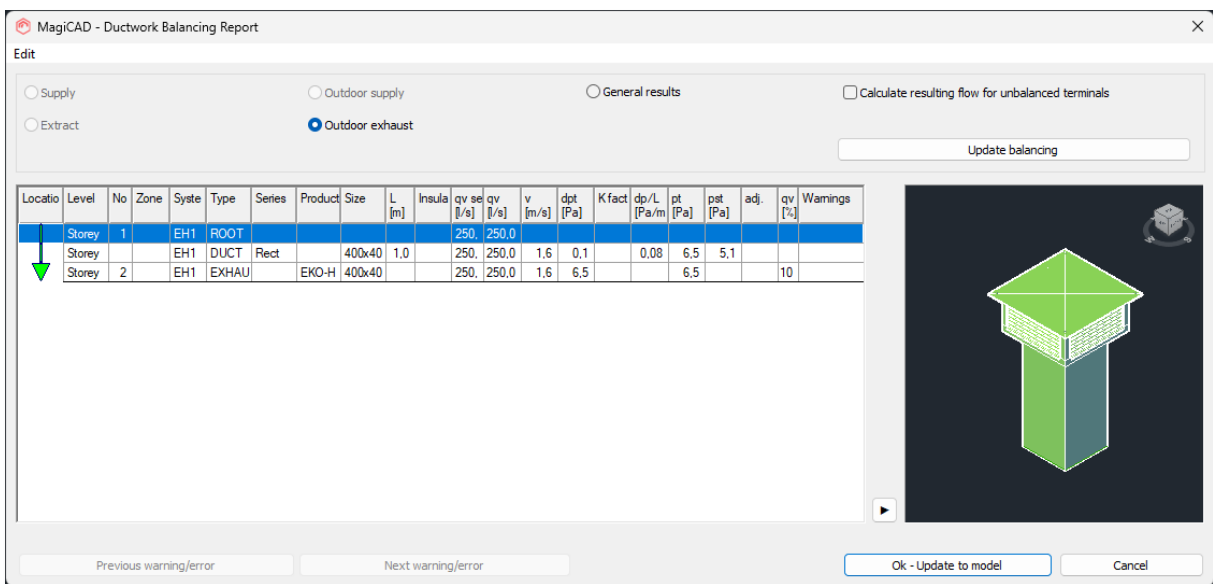

Figure 8 MagiCAD Ductwork balancing report

Detailed Insert Outdoor Supply function

Pre-requirement for inserting the outdoor supply type roof hoods and inlets is to have the MagiCAD project with at least one outdoor supply system. Without the system, user can view the products in EKOVENT selection tool with plugin but insert function is not available. If the required system is missing, plugin will inform user about this with a specific dialog.

Follow these steps to insert the roof hood and inlet products to AutoCAD drawing and MagiCAD project.

1. Start the insert operation from EKOVENT panel button or type the command **EKOVENT_INS_OUT**.
2. If MagiCAD project contains the required outdoor supply system, the EKOVENT selection tool is opened in plugin and all the outdoor supply type roof hoods and suitable inlets are available for selection. User can filter the products with technical data or select a specific product.

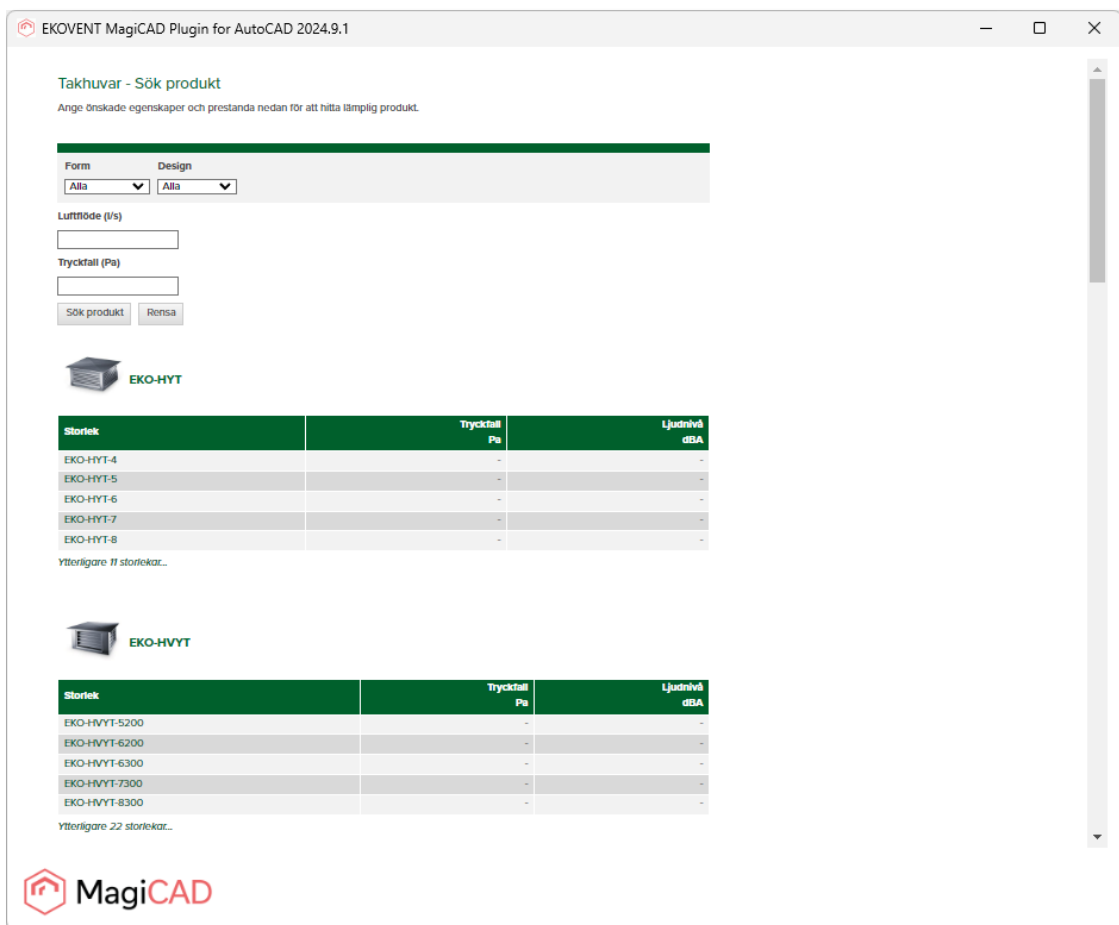
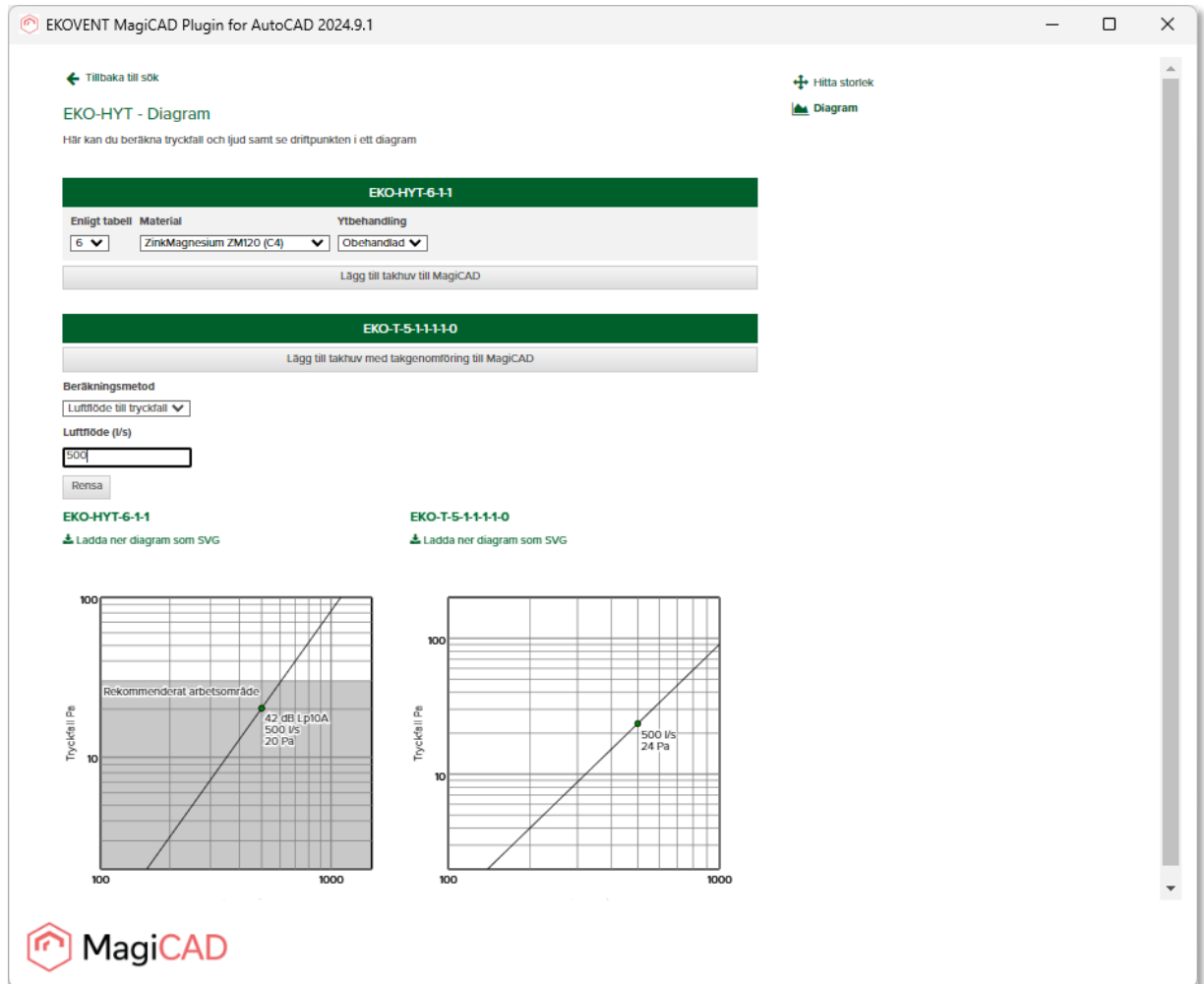

Figure 9 EKOVENT Selection tool with outdoor supply roof hoods

- After the desired product family and variant is selected, user can see the product variant specific data according to given air flow value. Finally, user starts the insert function of the roof hood or the combination of roof hood and inlet from dedicated button in selection tool.



The screenshot shows the EKOVENT MagiCAD Plugin for AutoCAD 2024.9.1 interface. The main window displays the 'EKO-HYT - Diagram' section, which allows users to calculate pressure drop and sound power level for a selected product variant. The interface includes a search bar, a 'Hitta storlek' button, and a 'Diagram' button. The selected product variant is 'EKO-HYT-6-1-1', with a material of 'ZinkMagnesium ZMI20 (C4)' and a surface treatment of 'Obehandlad'. The calculation method is set to 'Luftflöde till tryckfall'. The air flow rate is set to 500 l/s. Two performance diagrams are shown: one for 'EKO-HYT-6-1-1' and one for 'EKO-T-5-1-1-1-0'. The first diagram shows a recommended operating range (Rekommenderat arbetsområde) with a point at 42 dB Lp10A, 500 l/s, and 20 Pa. The second diagram shows a point at 500 l/s and 24 Pa. The MagiCAD logo is visible in the bottom left corner.

Figure 10 EKOVENT Selection tool with product view

4. Next plugin shows the Insert roof hood dialog where user can:
 - See the product codes of the selected products.
 - Change the plugin generated user code for roof hood.
 - Change the offset (product height level) values for roof hood.
 - Change the inlet user code, if inlet was selected.
 - Change the offset values for inlet, if inlet was selected.
 - Select the outdoor supply ventilation system and air flow.

Insert function is finalized with insert button.

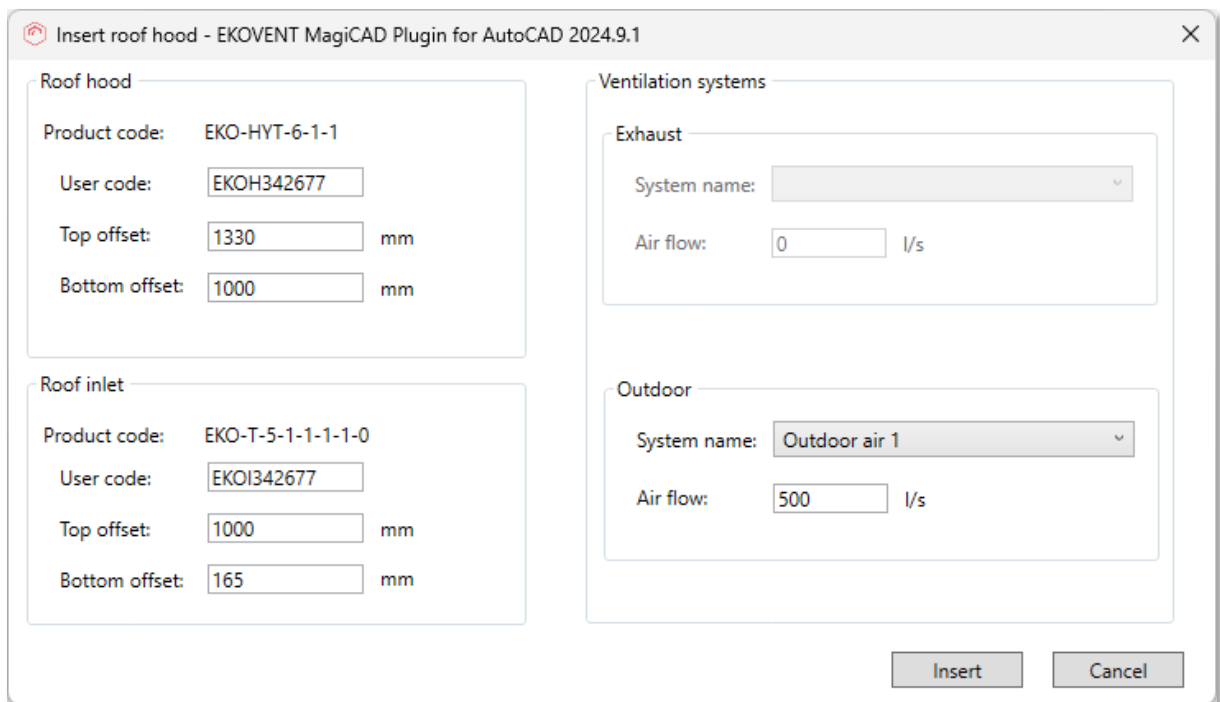

The dialog box is titled "Insert roof hood - EKOVENT MagiCAD Plugin for AutoCAD 2024.9.1". It contains the following fields:

- Roof hood:**
 - Product code: EKO-HYT-6-1-1
 - User code:
 - Top offset: mm
 - Bottom offset: mm
- Roof inlet:**
 - Product code: EKO-T-5-1-1-1-1-0
 - User code:
 - Top offset: mm
 - Bottom offset: mm
- Exhaust:**
 - System name:
 - Air flow: l/s
- Outdoor:**
 - System name:
 - Air flow: l/s

Buttons:

Figure 11 EKOVENT plugin dialog with outdoor supply and inlet products

5. Finally, user is able to drag and drop the 3D geometry object in the AutoCAD drawing and rotate the product. Product is connected to exhaust ventilation ductwork with its bottom connector.

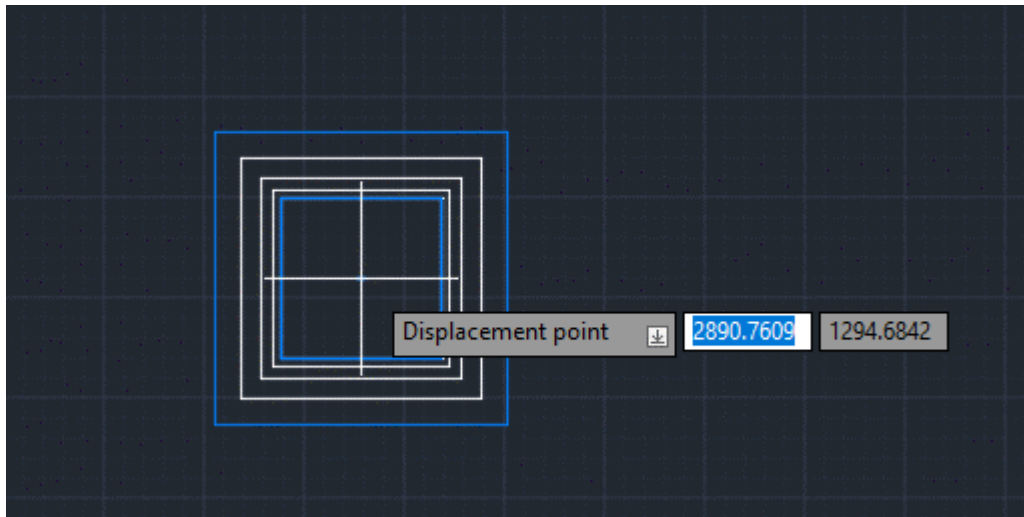

Figure 12 Outdoor supply roof hood and inlet products placement in AutoCAD drawing

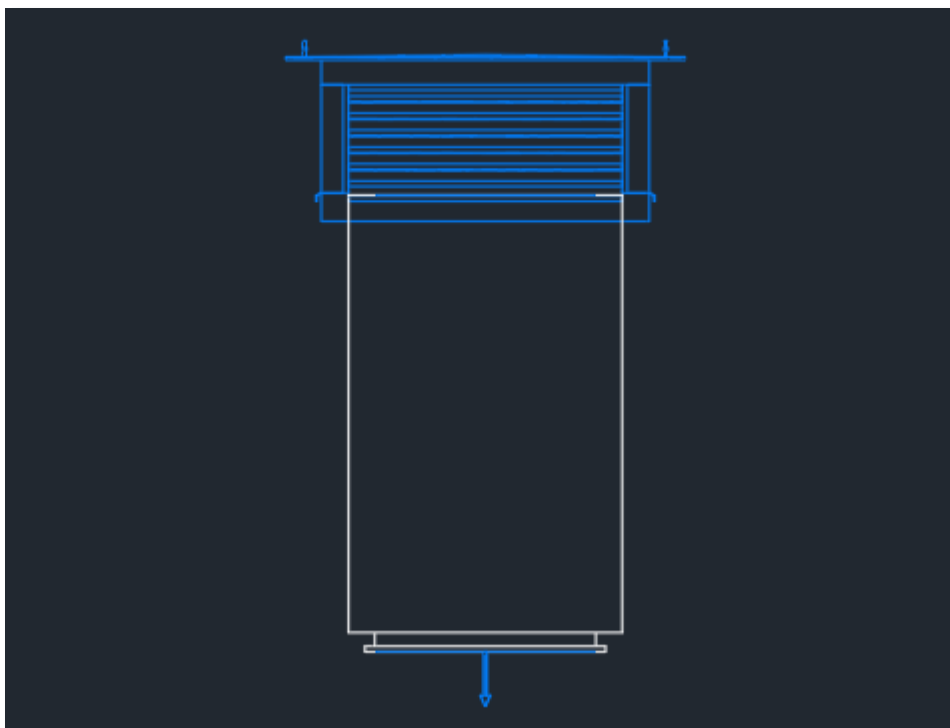

Figure 13 Outdoor supply roof hood and inlet products 3D geometry in AutoCAD drawing

- Product specific technical data is visible in the MagiCAD part properties dialog and also in MagiCAD ductwork balancing report after the balancing calculation is run.

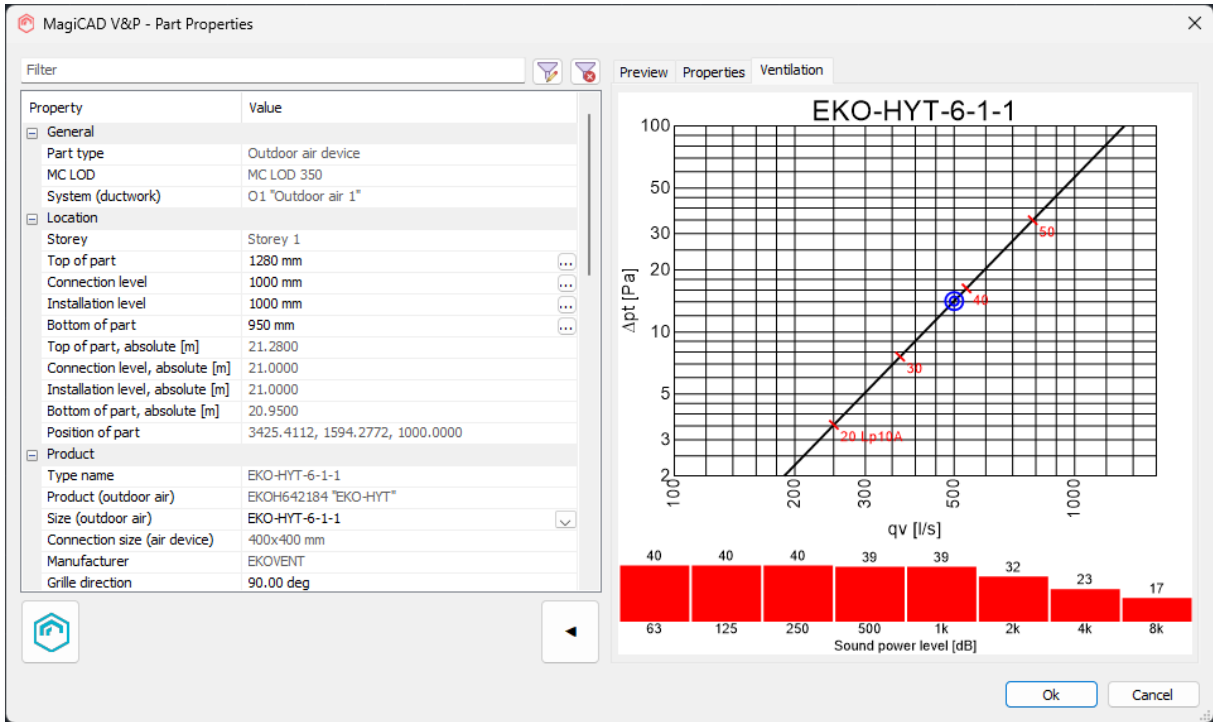

Figure 14 MagiCAD Part properties dialog

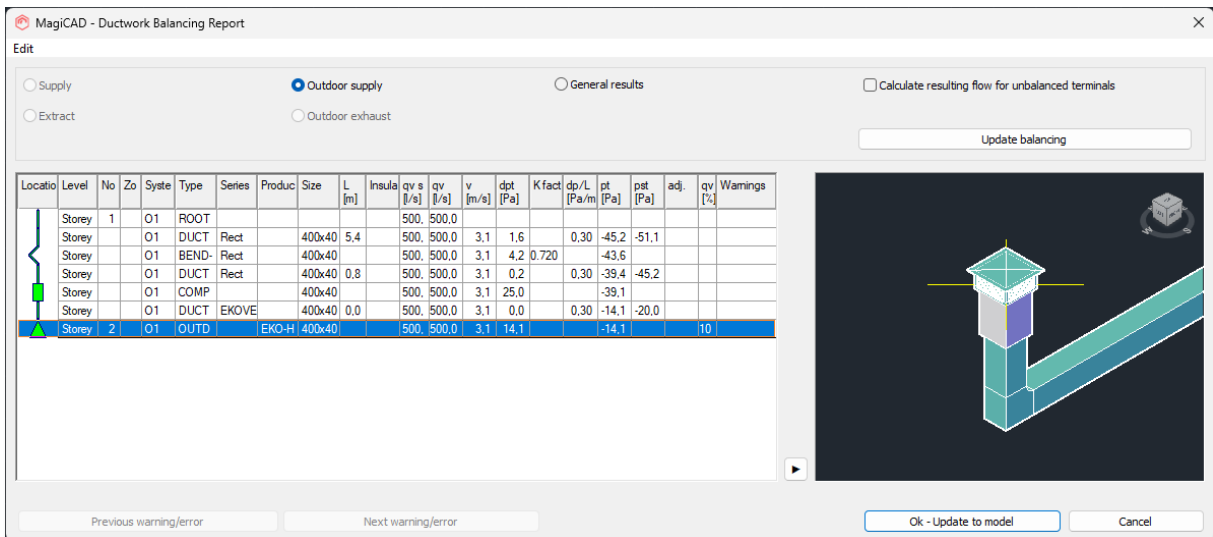

Figure 15 MagiCAD Ductwork balancing report

Detailed Insert Combination function

Pre-requirement for inserting the combination type roof hoods and inlets is to have the MagiCAD project with at least one exhaust system and outdoor supply system. Without the systems, user can view the products in EKOVENT selection tool with plugin but insert function is not available. If the required systems are missing, plugin will inform user about this with a specific dialog.

Follow these steps to insert the roof hood and inlet products to AutoCAD drawing and MagiCAD project.

1. Start the insert operation from EKOVENT panel button or type the command **EKOVENT_INS_COMBI**.
2. If MagiCAD project contains the required exhaust and outdoor supply systems, the EKOVENT selection tool is opened in plugin and all the combination type roof hoods and suitable inlets are available for selection. User can filter the products with technical data or select a specific product.

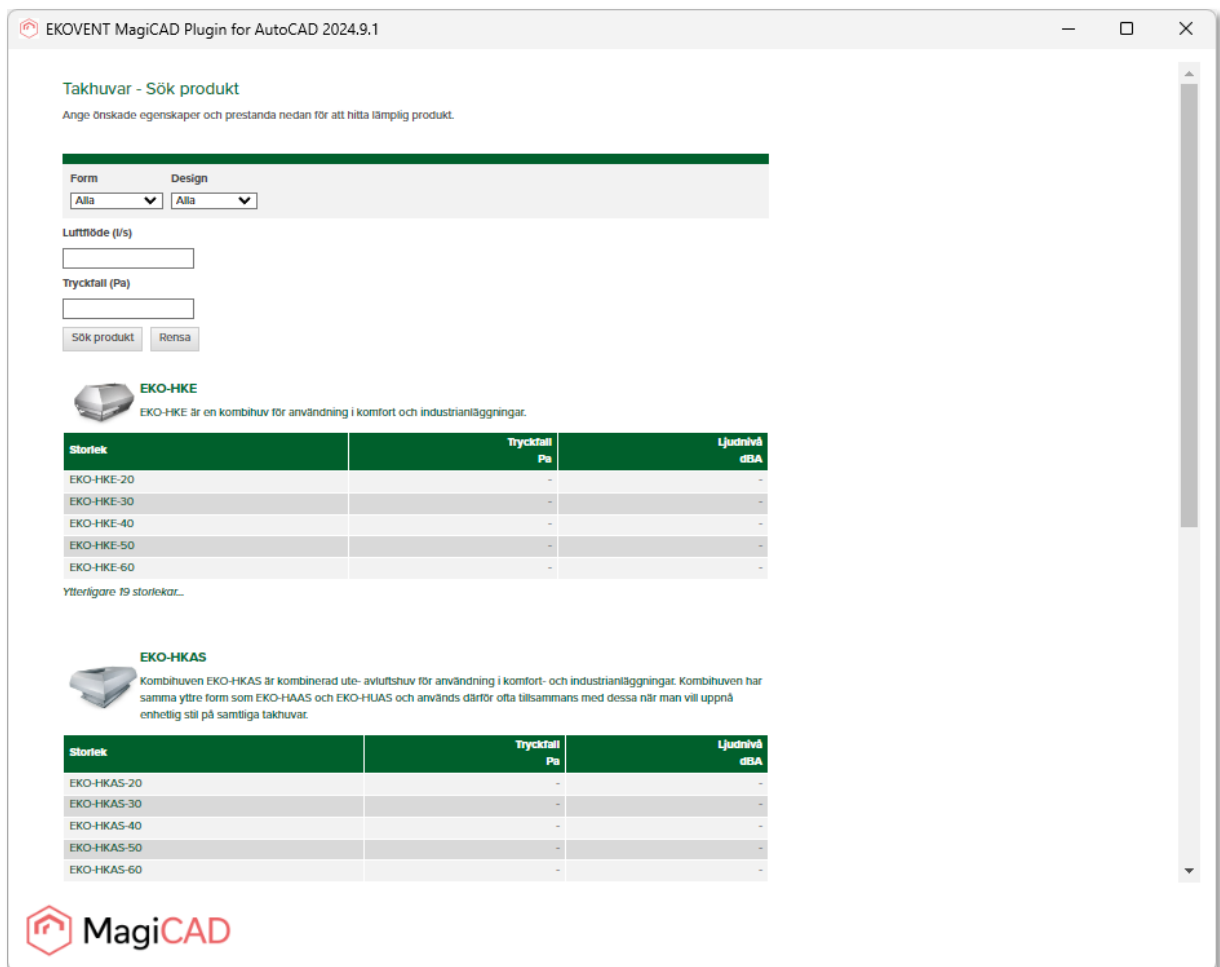
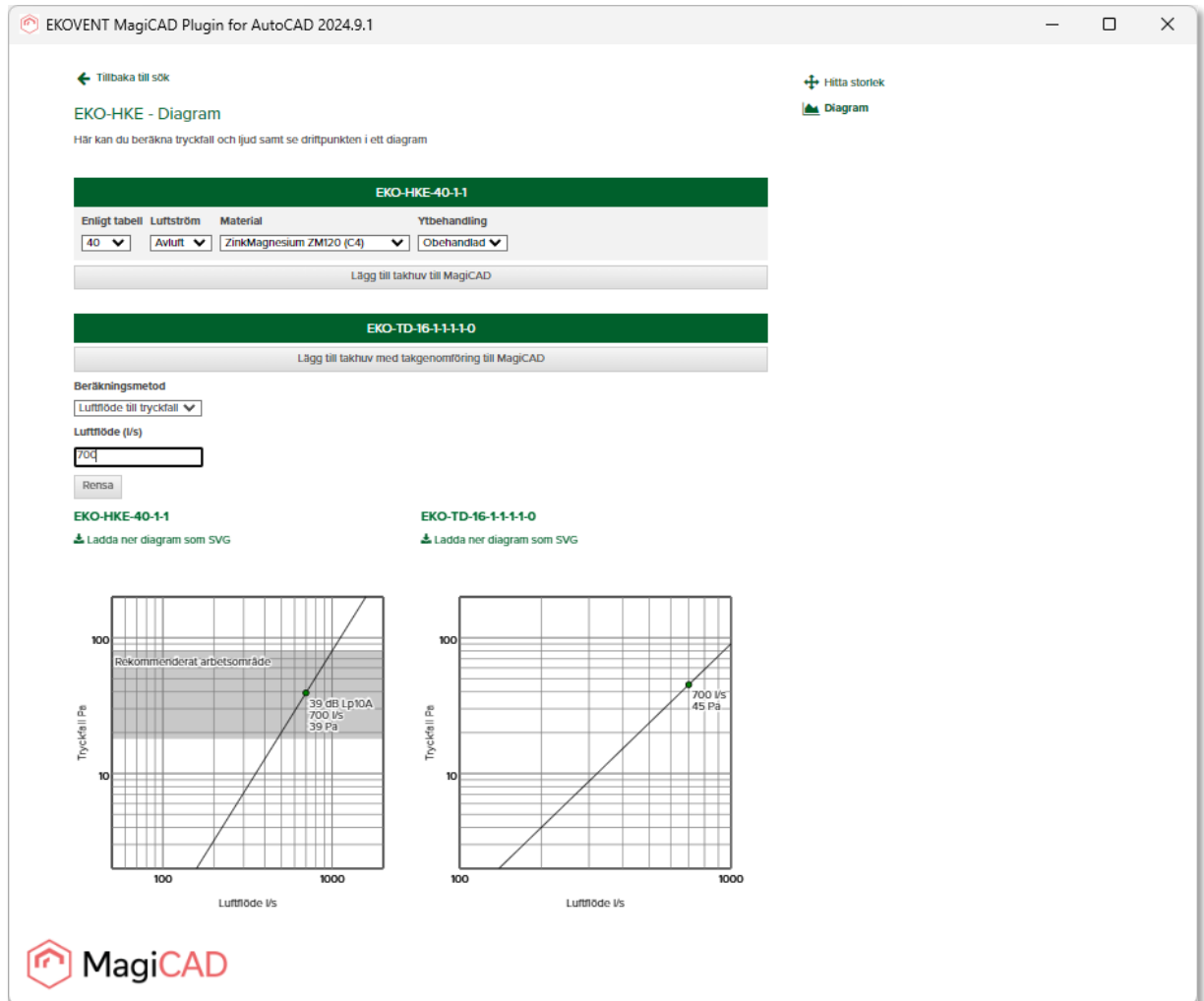

Figure 16 EKOVENT Selection tool with combination roof hoods

- After the desired product family and variant is selected, user can see the product variant specific data according to given air flow value. Finally, user starts the insert function of the roof hood or the combination of roof hood and inlet from dedicated button in selection tool.



The screenshot shows the EKOVENT MagiCAD Plugin for AutoCAD 2024.9.1 interface. It features a navigation bar with 'Tillbaka till sök' and 'Hitta storlek'. The main area is titled 'EKO-HKE - Diagram' and includes a sub-header 'Här kan du beräkna tryckfall och ljud samt se drittpunkten i ett diagram'. Below this, there are two product selection sections:

- EKO-HKE-40-1-1**: Includes a table with columns 'Enligt tabell', 'Luftström', 'Material', and 'Ytbehandling'. The values are '40', 'Avluft', 'ZinkMagnesium ZM120 (C4)', and 'Obehandlad' respectively. A button 'Lägg till takhuv till MagiCAD' is located below the table.
- EKO-TD-16-1-1-1-0**: Includes a button 'Lägg till takhuv med takgenomföring till MagiCAD'.

Below the product selection, there are input fields for 'Beräkningsmetod' (set to 'Luftflöde till tryckfall') and 'Luftflöde (l/s)' (set to '700'). A 'Rensa' button is also present. Two performance diagrams are displayed:

- EKO-HKE-40-1-1**: A log-log plot of 'Tryckfall Pa' (10 to 100) vs 'Luftflöde l/s' (100 to 1000). A shaded 'Rekommenderat arbetsområde' is shown. A data point is marked at 700 l/s and 39 Pa, with a noise level of 39 dB Lp10A.
- EKO-TD-16-1-1-1-0**: A log-log plot of 'Tryckfall Pa' (10 to 100) vs 'Luftflöde l/s' (100 to 1000). A data point is marked at 700 l/s and 45 Pa.

The MagiCAD logo is visible at the bottom left of the interface.

Figure 17 EKOVENT Selection tool with product view

4. Next plugin shows the Insert roof hood dialog where user can:
 - See the product codes of the selected products.
 - Change the plugin generated user code for roof hood.
 - Change the offset (product height level) values for roof hood.
 - Change the inlet user code, if inlet was selected.
 - Change the offset values for inlet, if inlet was selected.
 - Select the exhaust and outdoor supply ventilation system and air flow values.

Insert function is finalized with insert button.

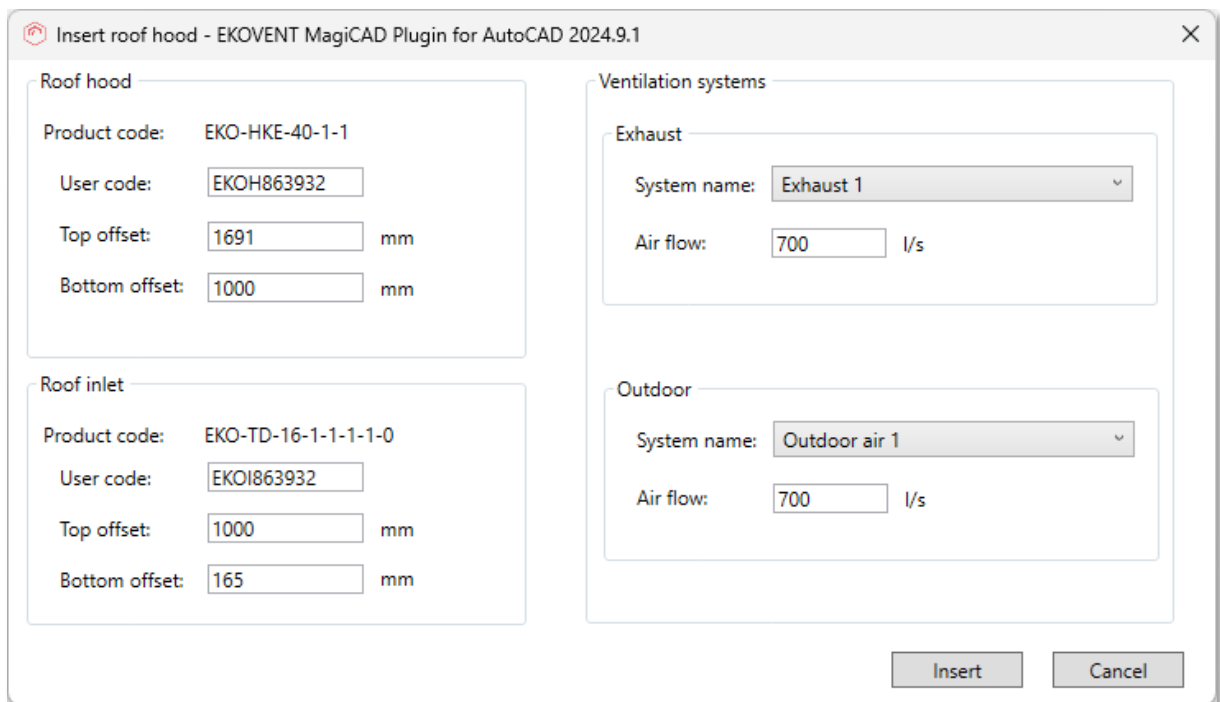

Figure 18 EKOVENT plugin dialog with combination and inlet products

5. Finally, user is able to drag and drop the 3D geometry object in the AutoCAD drawing and rotate the product. Product is connected to exhaust ventilation ductwork with its bottom connector.

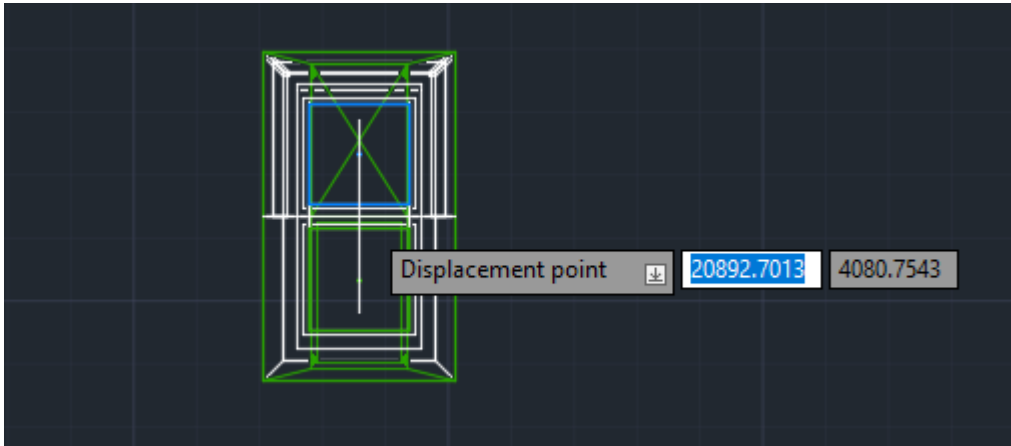

Figure 19 Combination roof hood and inlet products placement in AutoCAD drawing

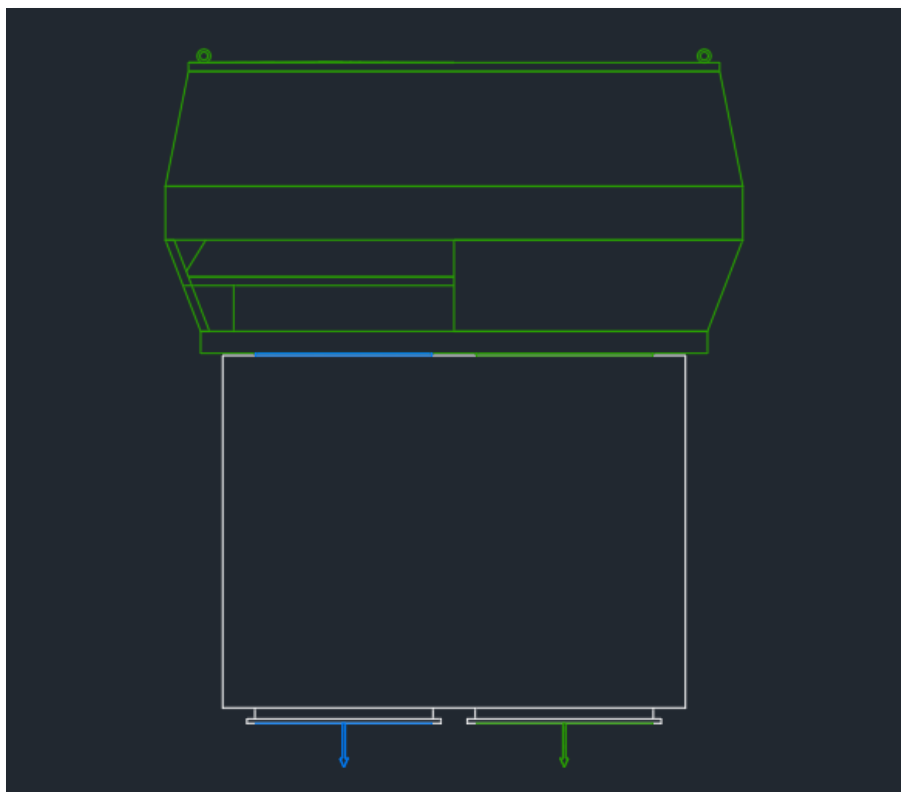

Figure 20 Combination roof hood and inlet products 3D geometry in AutoCAD drawing

- Product specific technical data is visible in the MagiCAD part properties dialog and also in MagiCAD ductwork balancing report after the balancing calculation is run.

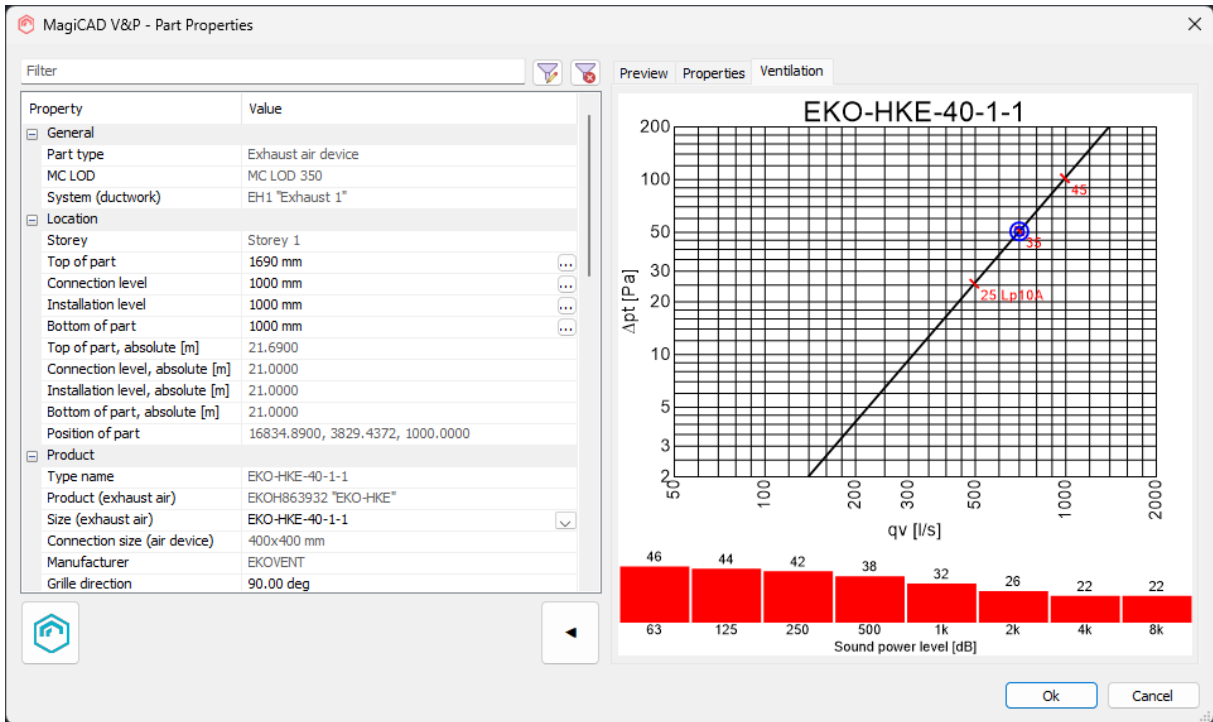

Figure 21 MagiCAD Part properties dialog

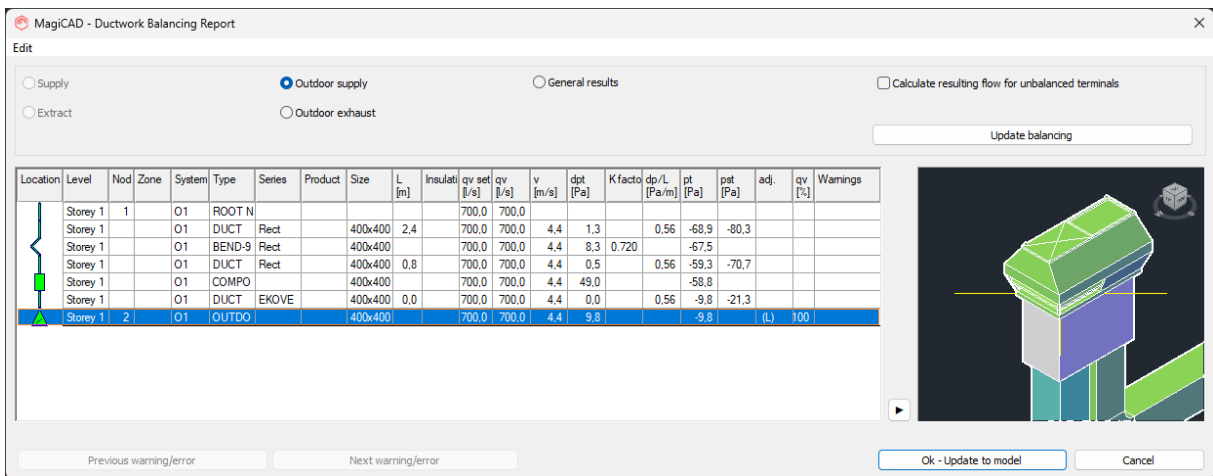

Figure 22 MagiCAD Ductwork balancing report for outdoor part

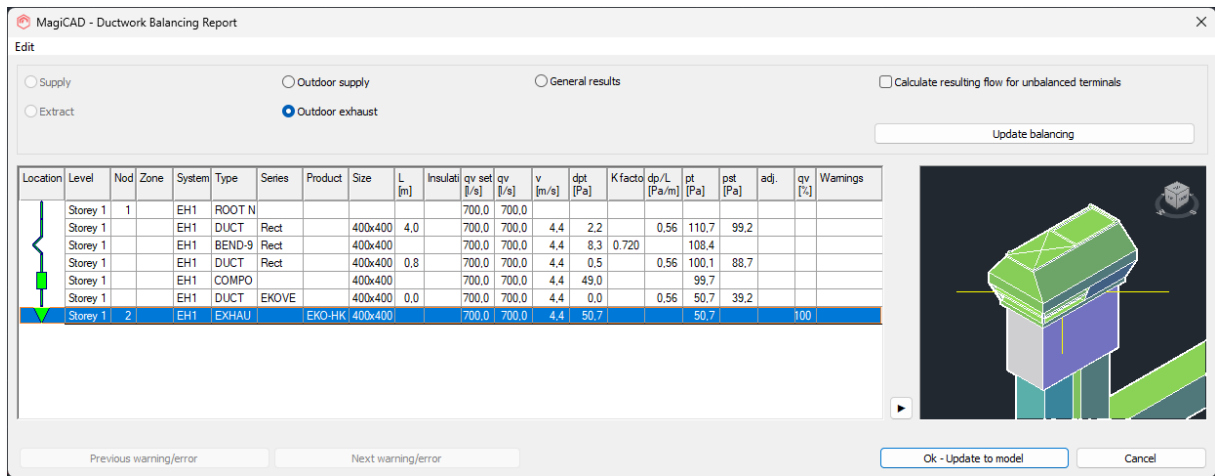

Figure 23 MagiCAD Ductwork balancing report for exhaust part