

A decorative background consisting of several nested, light blue geometric shapes that resemble stylized architectural elements or a maze. The shapes are composed of thick, solid blue lines.

Belimo MagiCAD Cloud Plugin for Revit

13/04/2026

Content

1	GENERAL	3
1.1	About This Document.....	3
1.2	Installing the Plugin	3
1.2.1	Required Software.....	3
1.2.2	Installation	3
1.3	Starting the Plugin	4
2	HOW TO USE THE PLUGIN	5
2.1	Insert / Export operation	5
2.1.1	Product selection.....	5
2.1.2	Product installation with MagiCAD	12
2.1.3	Product installation with Revit	16
2.2	Import operation	18

1 General

1.1 About This Document

This document contains instructions on how to install and use *Belimo MagiCAD plugin for Revit*.

Belimo plugin is Autodesk Revit add-in application, and it works on Revit platform with and without MagiCAD.

1.2 Installing the Plugin

1.2.1 Required Software

Belimo MagiCAD plugin for Revit works with the following MagiCAD and Revit versions.

Revit

- Revit 2024-2027

MagiCAD for Revit (optional)

- MagiCAD 2026 with Revit versions 2024-2026
- MagiCAD 2027 with Revit versions 2025-2027

1.2.2 Installation

Administrator privileges are recommended for installation.

1. Download the installation package from MagiCAD portal.

<https://portal.magicad.com/download/ProductSearch?searchStr=Belimo&categoryId=3>

2. Run the installer on your workstation.

1.3 Starting the Plugin

The plugin is automatically loaded, and it is ready to be used once Revit is started next time after the plugin installation.

Belimo plugin ribbon panel can be found from MagiCAD Connect tab in Revit. When the drop-down button is clicked, the list of available operations will be shown. Plugin contains two operations:

- Insert / Export which contains the insert or export of valve and actuator product combinations from Belimo's valve selection tool. The exported file will be used in Import operation.
- Import which contains the import of valve and actuator product combinations from a file which is exported from Belimo's selection tool.

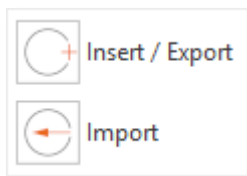

2 How to use the plugin

2.1 Insert / Export operation

2.1.1 Product selection

This command opens the Belimo's valve and actuator selection tool in plugin browser where user can select the valve and actuator and filter the products according to the needs. The product selection part is the same no matter if the platform is Revit with or without MagiCAD. Anyway, there might be some product range limitations depending on the used platform.

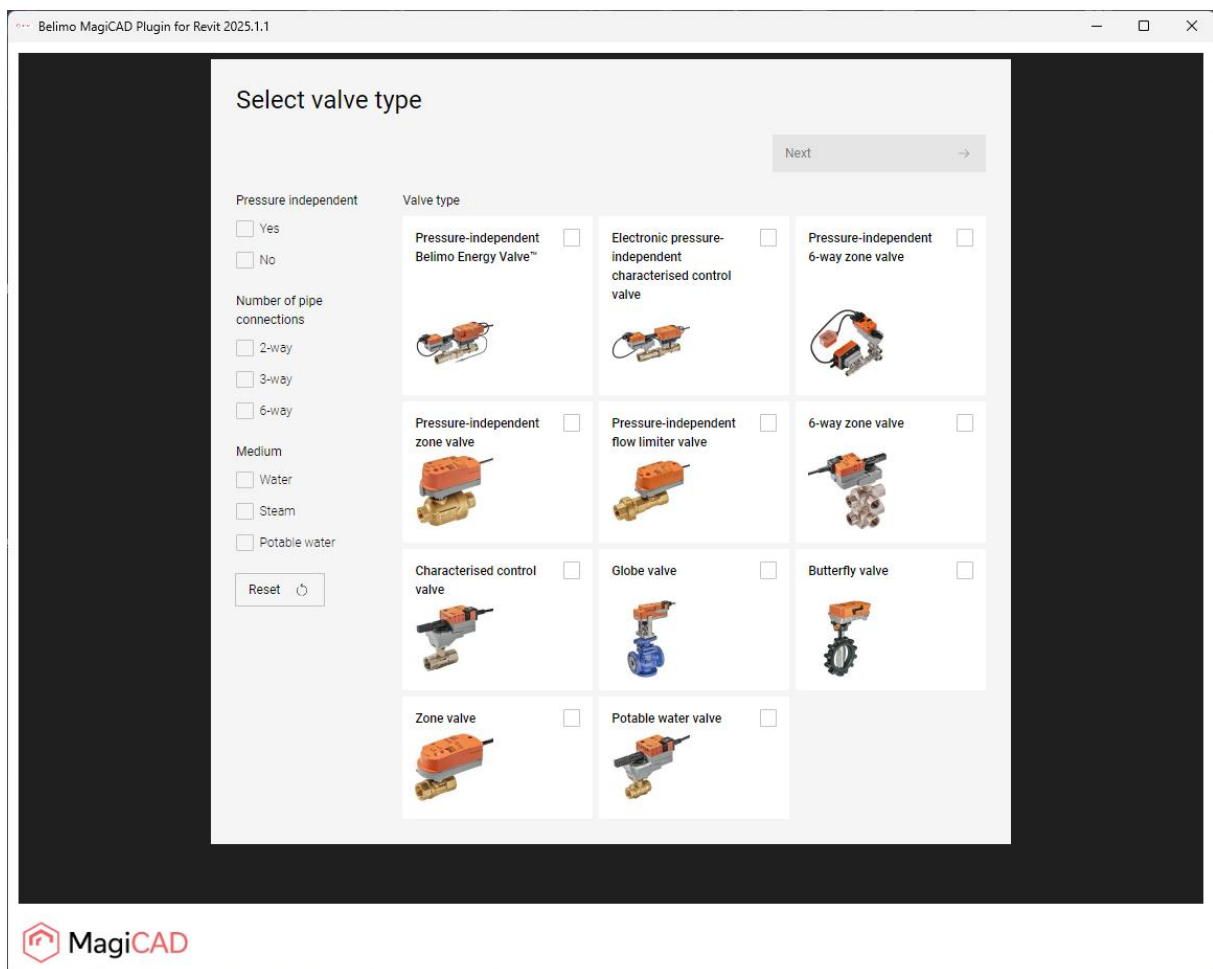

If Revit is used with MagiCAD, the selected product family will be inserted into MagiCAD dataset. After this, user can install a new family instance (from the same family) via MagiCAD's own install functions to Revit model. All product specific technical data is available for MagiCAD calculations.

If Revit is used without MagiCAD, the plugin creates the product family (RFA), and the product family instance will be inserted to Revit model.

The user selected valve and actuator accessories are visible in inserted family instance as Revit shared parameters. Pipe connector accessories also in geometry.

1. Find the MagiCAD Connect tab, Belimo panel and start the *Insert* operation from ribbon button.

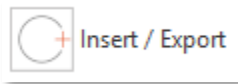

2. Select the type of valve and filter the product selection. After the selection click the *Next* button.

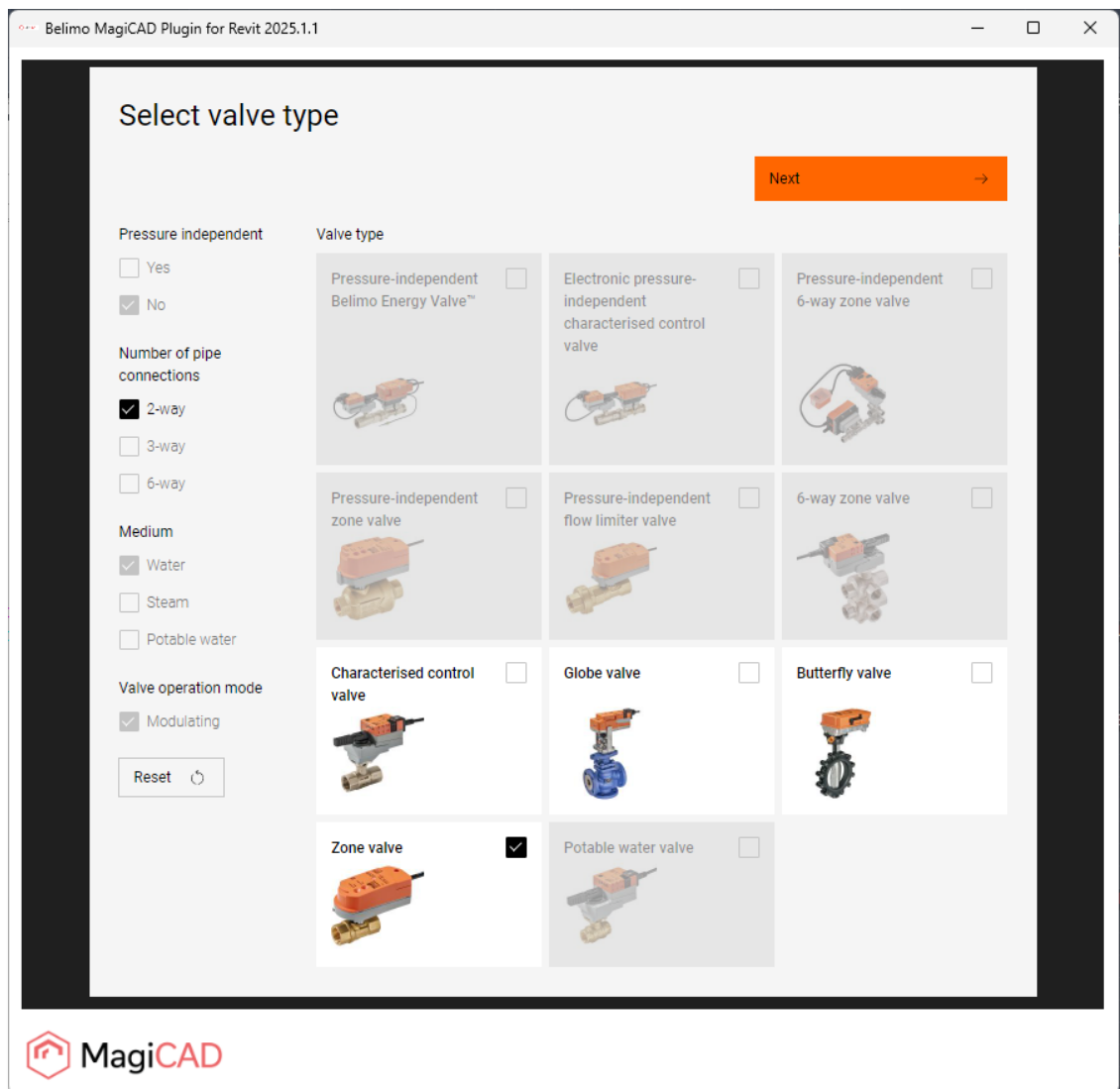

3. Give the design data to get recommended products or just click *Next* to select from all valve types.

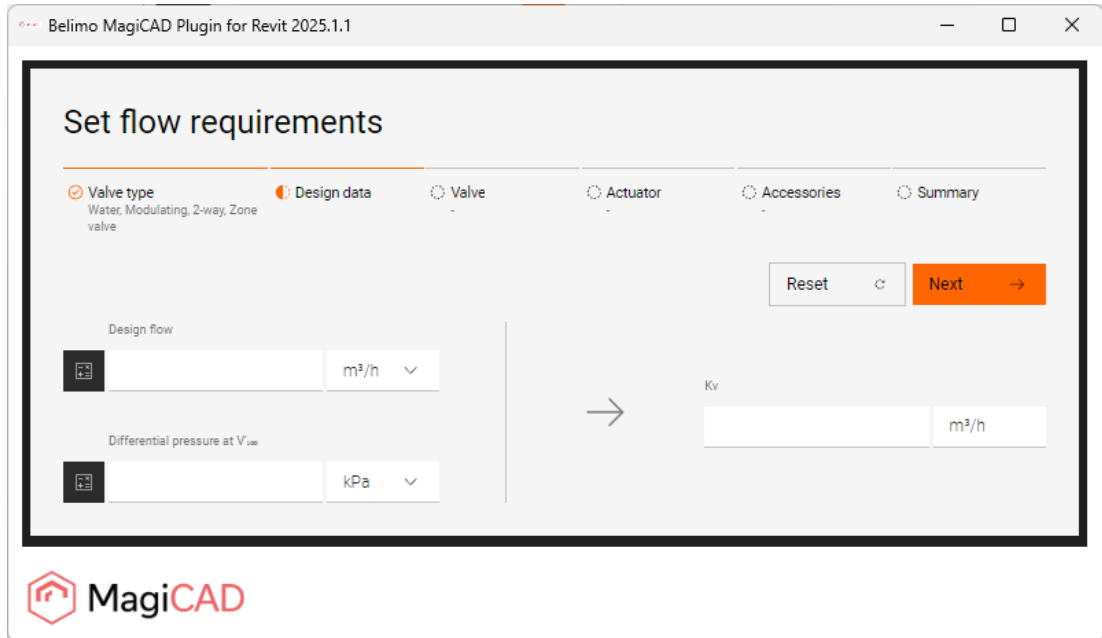

The screenshot shows the 'Set flow requirements' dialog box within the Belimo MagiCAD Plugin for Revit 2025.1.1. The dialog is titled 'Set flow requirements' and features a progress bar with six steps: 'Valve type' (selected), 'Design data', 'Valve', 'Actuator', 'Accessories', and 'Summary'. Under 'Valve type', the selected option is 'Water, Modulating, 2-way, Zone valve'. The 'Design data' step is active, showing two input fields: 'Design flow' (with a unit dropdown set to m³/h) and 'Differential pressure at V_{max}' (with a unit dropdown set to kPa). To the right of these fields is a large arrow pointing to a 'Kv' field, which also has a unit dropdown set to m³/h. At the top right of the dialog are 'Reset' and 'Next' buttons. The MagiCAD logo is visible at the bottom left of the dialog window.

- Select the valve and click *Next* button. Note that even a single valve product variant is selected in this phase, all the product variants from the same product family are available in the product installation when MagiCAD is available.

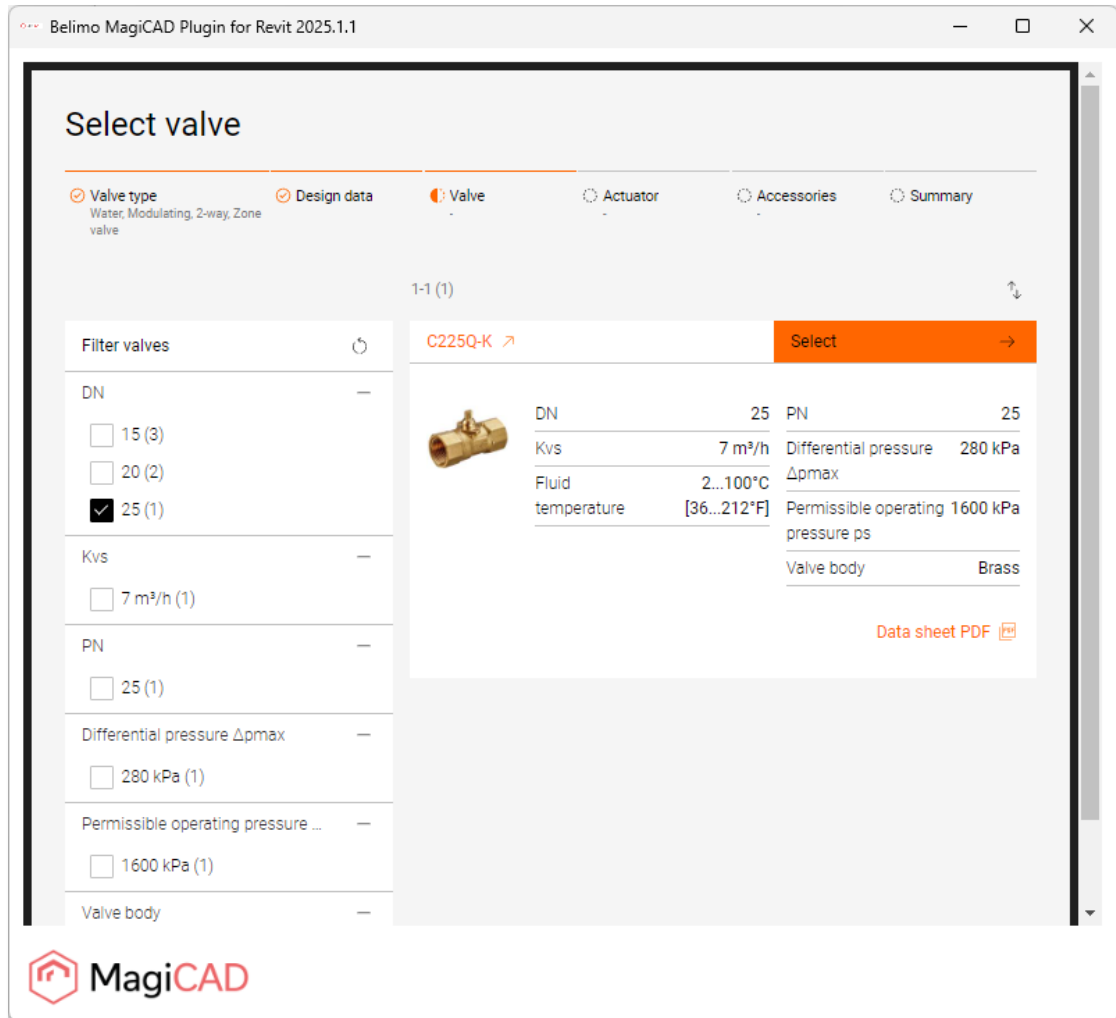

5. Select the actuator for valve and click *Next* button.

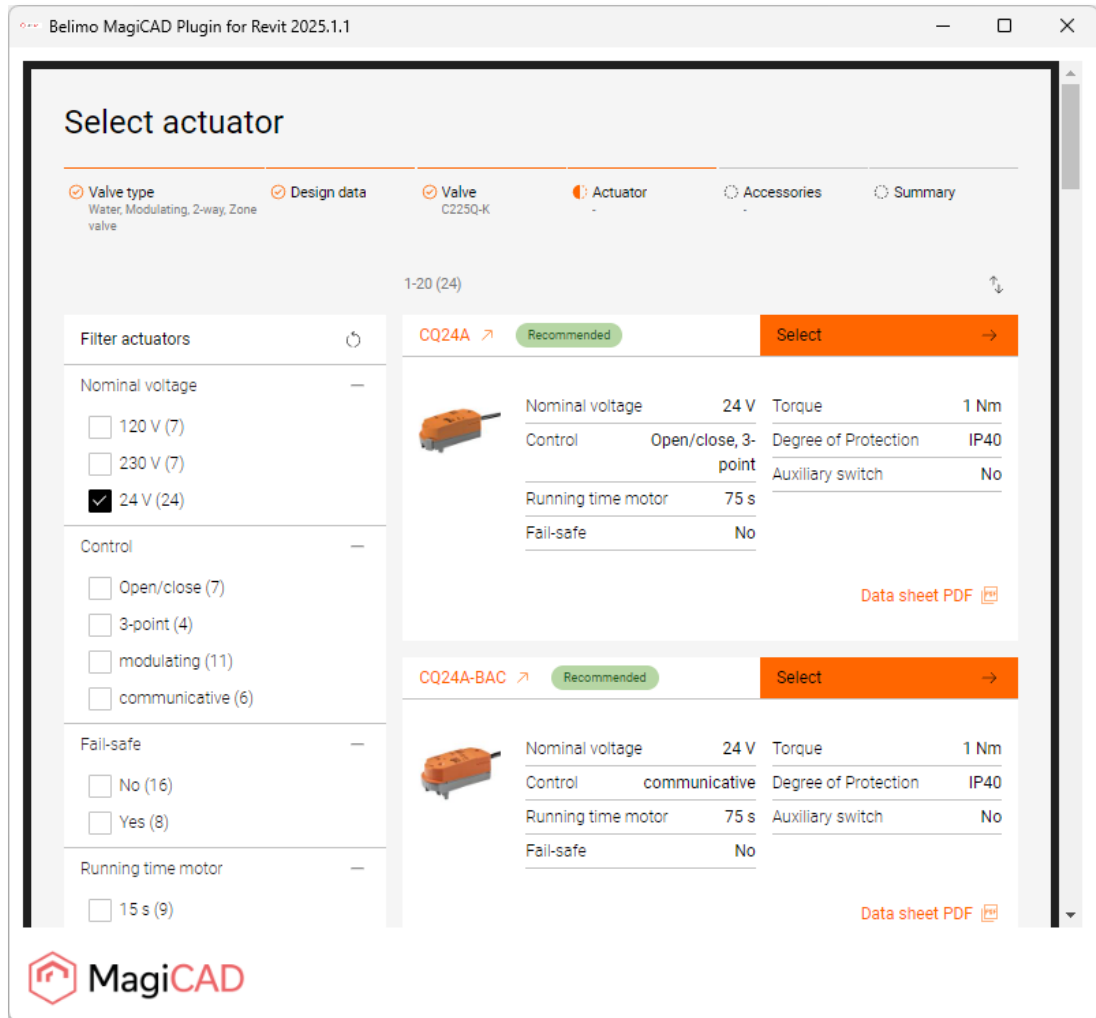

- Select the accessories for valve and actuator. Accessories are visible in the Revit family instance as shared parameters. Pipe connectors are visible also in the product geometry. Click *Next* button to proceed.

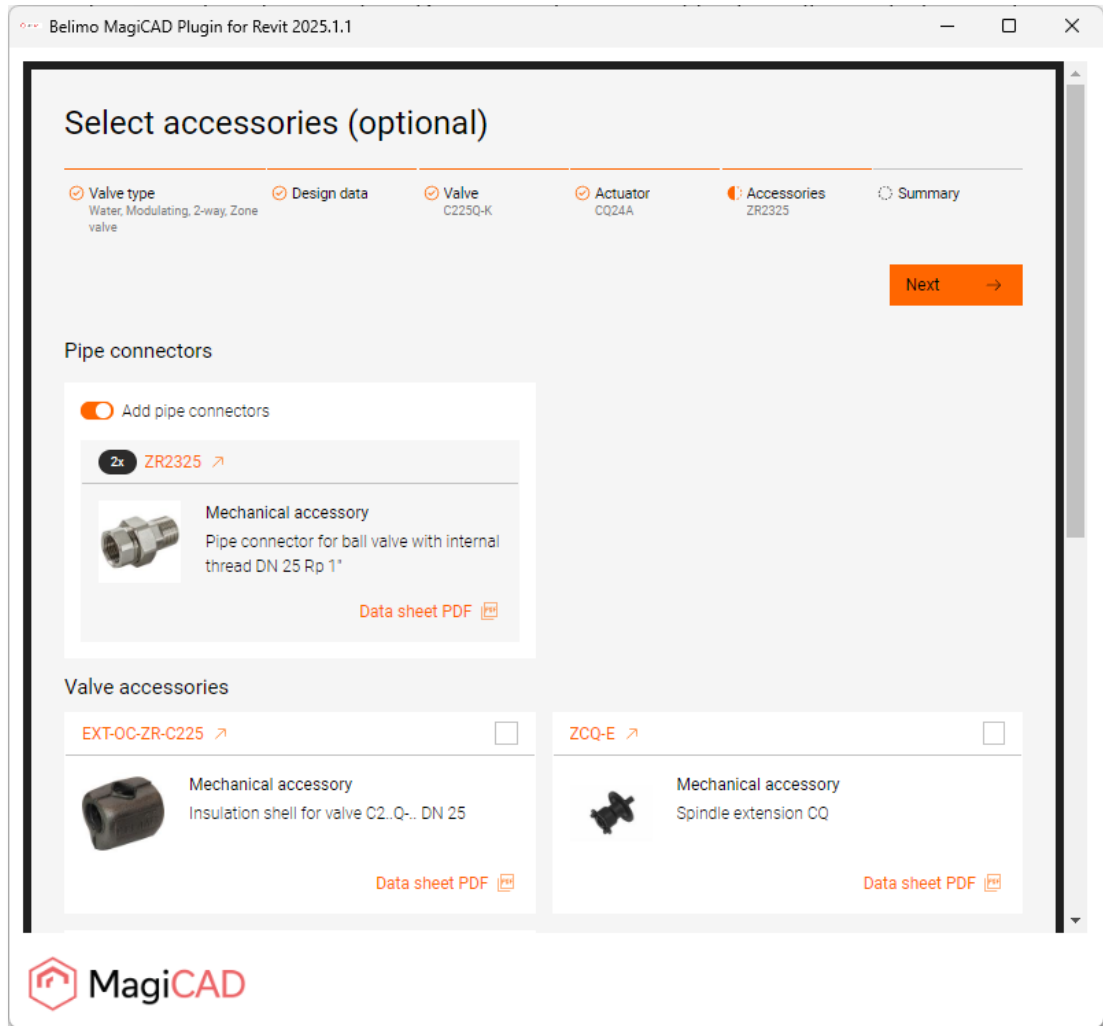

7. Finally, the summary of the selection is shown.

Click the **Insert to Revit** button to insert the selected valve, actuator and accessories to Revit. When button is clicked the selection tool is closed and operation continues on the Revit.

Click the **Export selection** button to export the selected valve, actuator and accessories to workstation as .MVEF file. When button is clicked the selection tool will save the file to a location and name selected by user. This file will be later used in **Import** operation.

For product installation Revit:

- In case of Revit with MagiCAD, see chapter 2.1.2.
- In case of Revit without MagiCAD, see chapter 2.1.3.

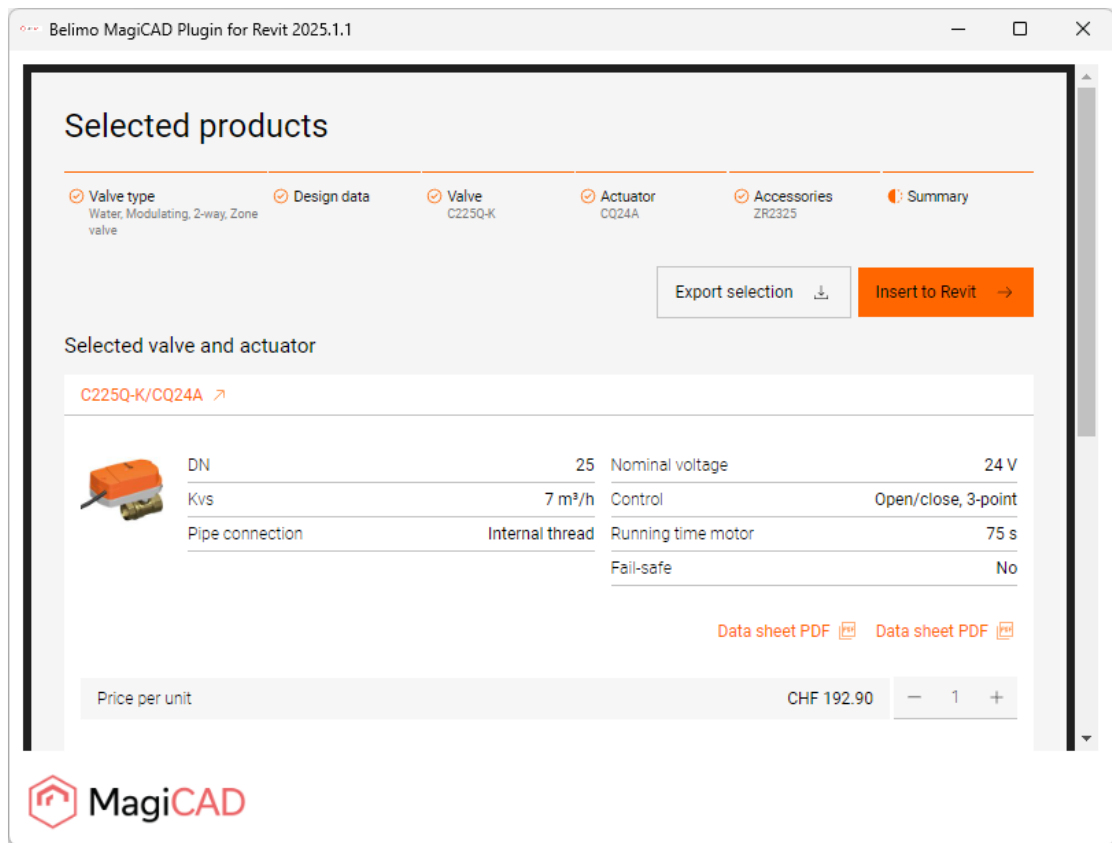

The screenshot shows the 'Selected products' window of the Belimo MagiCAD Plugin for Revit 2025.1.1. The window displays a summary of selected items: Valve type (Water, Modulating, 2-way, Zone valve), Design data, Valve (C225Q-K), Actuator (CQ24A), and Accessories (ZR2325). There are buttons for 'Export selection' and 'Insert to Revit'. Below this, the 'Selected valve and actuator' section shows the product 'C225Q-K/CQ24A' with a small image of the valve. A table lists technical specifications:

DN	25	Nominal voltage	24 V
Kvs	7 m³/h	Control	Open/close, 3-point
Pipe connection	Internal thread	Running time motor	75 s
		Fail-safe	No

At the bottom, there are links for 'Data sheet PDF' and a price per unit of CHF 192.90 with a quantity selector set to 1.

2.1.2 Product installation with MagiCAD

This chapter describes how the plugin will add the product to MagiCAD and Revit, after the product is selected and configured in Belimo's selection tool. Product is added to MagiCAD dataset and then it's installed in the Revit model. Valve and actuator family combination is added to Pipe accessories category in Revit.

1. First the product will be added to MagiCAD dataset, and the *Dataset properties* dialog is opened where the user can input the values for dataset and select the 2D symbol for the product. The product and variant specific pressure drop curve data is available from *Properties...* button.

Once all the input data is given, click *OK* button to add the product to MagiCAD dataset and proceed to product installation.

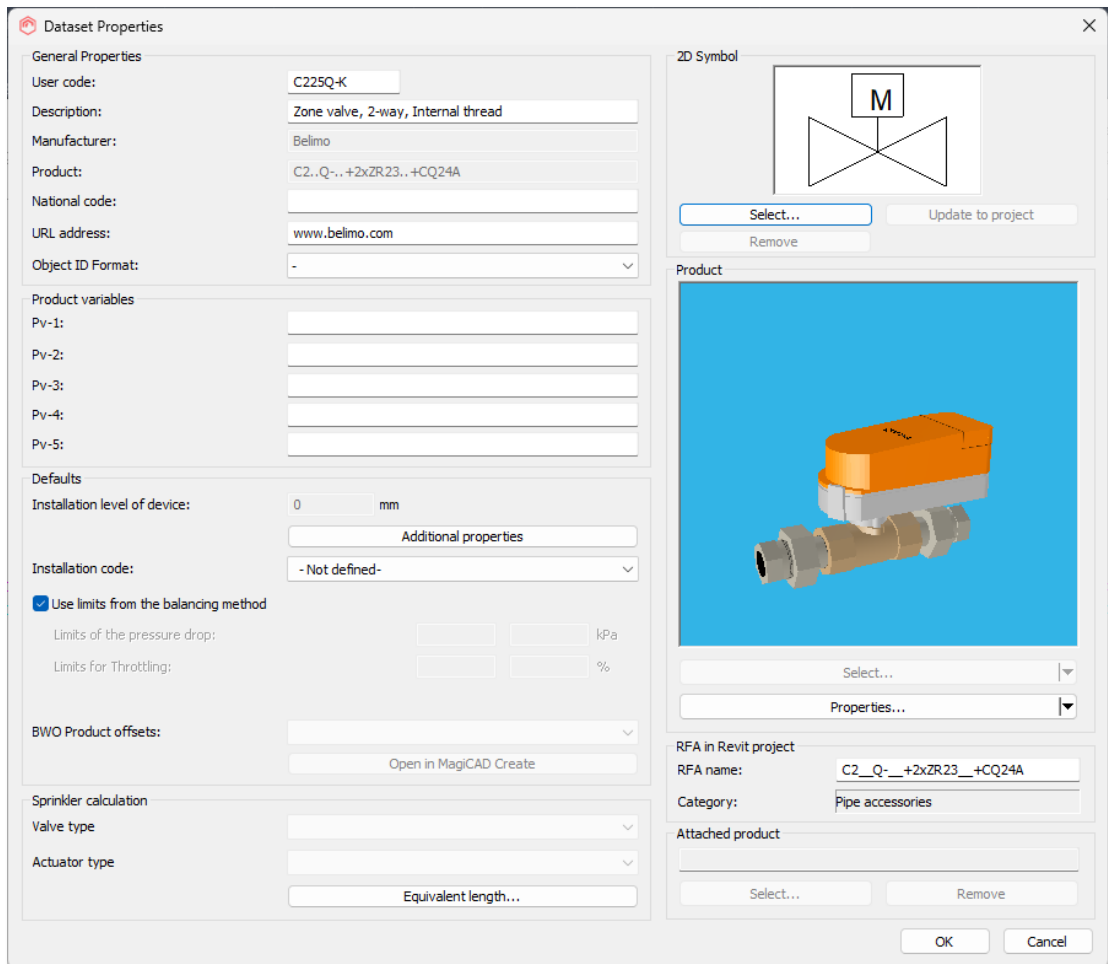

- The product installation is done from the *Product selection* dialog. The selected product is active in the dialog and it's possible to choose a different product variant at this point.

Click the Select button to proceed for product family and instance installation.

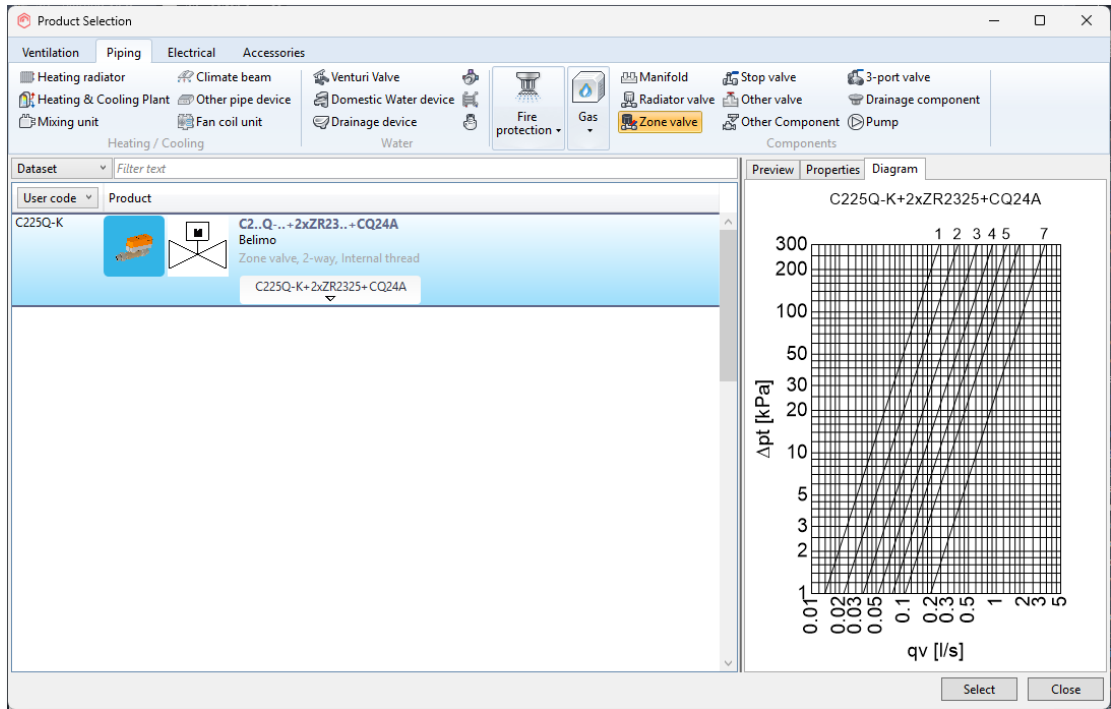

- From MagiCAD *Product Installation* dialog click the *Selected Size* button and the family and instance will be created.

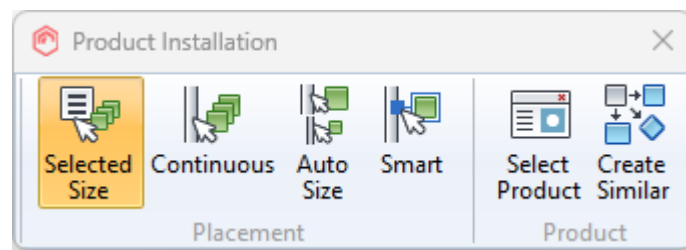

After the instance creation user can drag and drop the selected product and install product to the Revit pipe. Click the *Apply* button to apply the instance installation from *Product installation* dialog and install other instances if necessary.

End the product installation with *ESC* button.

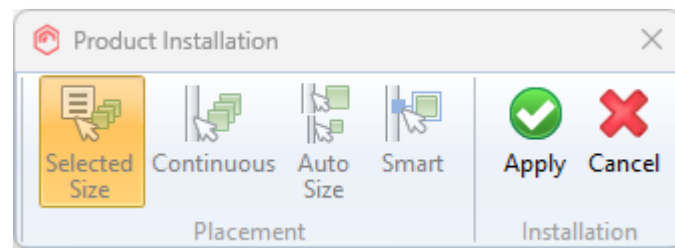
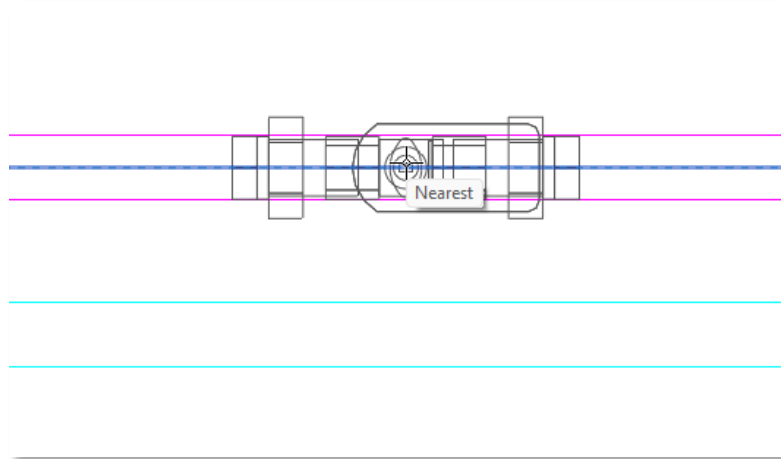

If Revit Properties dialog is open, click the installed instance to see the product properties and valve and actuator specific accessories. If dialog is not open, right click the product instance and select the properties.

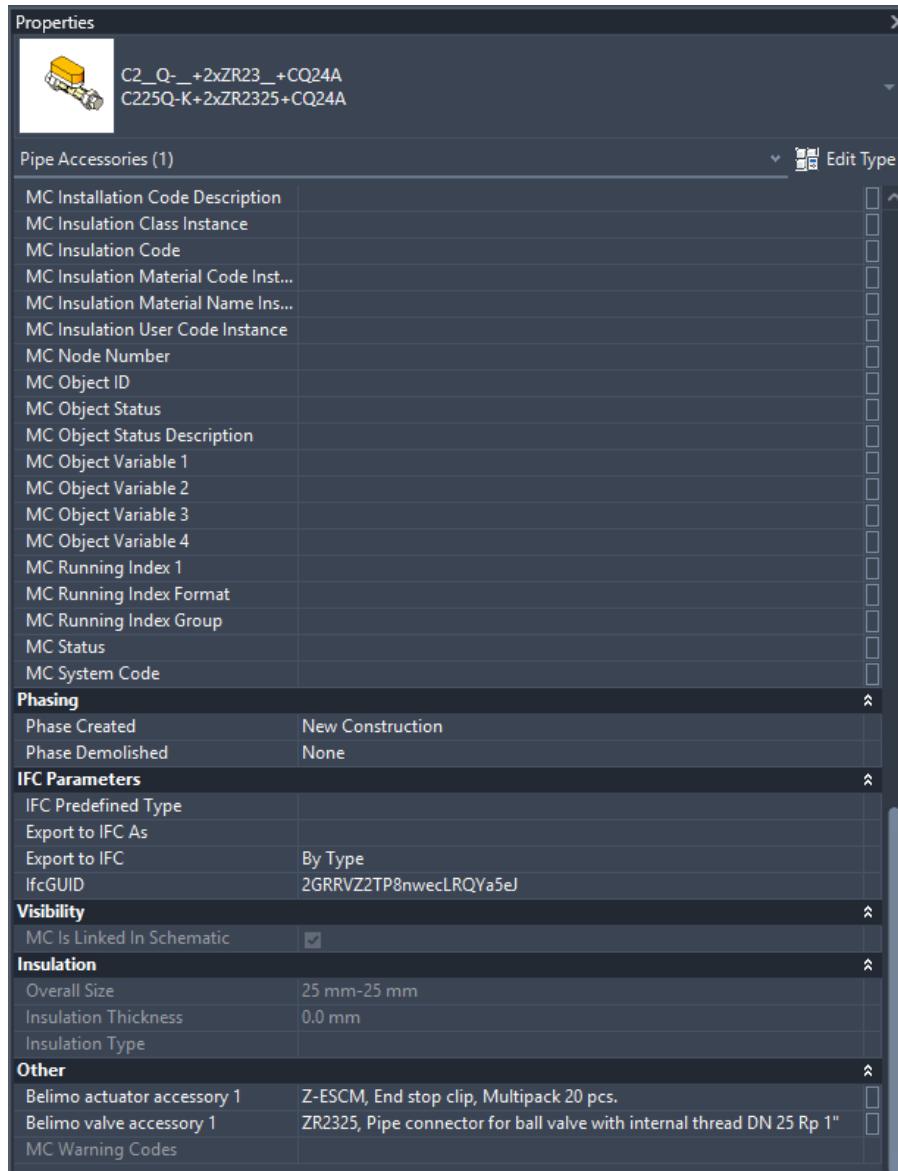

- Product installation is finished. The valve specific technical data is available for MagiCAD balancing and sizing calculation. Accessories specific data is available for bill of materials and Revit schedules.

2.1.3 Product installation with Revit

This chapter describes how the plugin will add the product to Revit, after the product is selected and configured in Belimo's selection tool. Product is installed in the Revit model.

1. Plugin opens the product *Insert* dialog where the user can select the product variant to be installed and 2D symbol for the product.

Proceed to family and instance creation with *Insert* button.

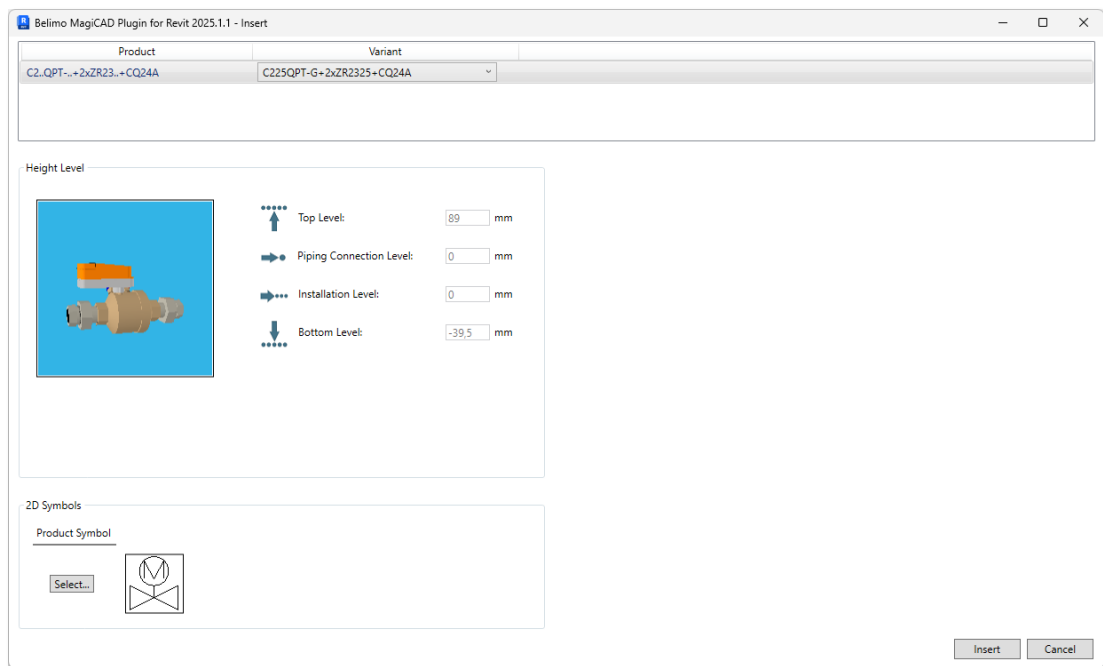

2. After the Insert click, plugin will create the Revit family from the selected product.

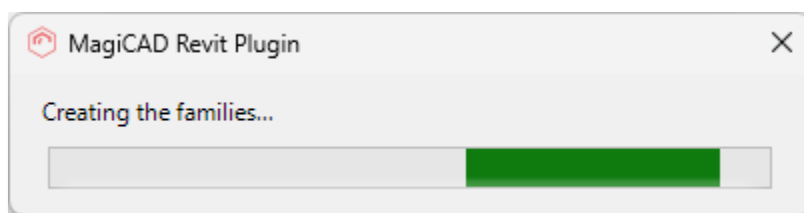

3. Once the product family has been created, the plugin creates a product family instance. User can insert the instance to a desired Revit pipe location. It is possible to insert more instances of the product after the initial insert. The user can stop insert operation by pressing ESC key.

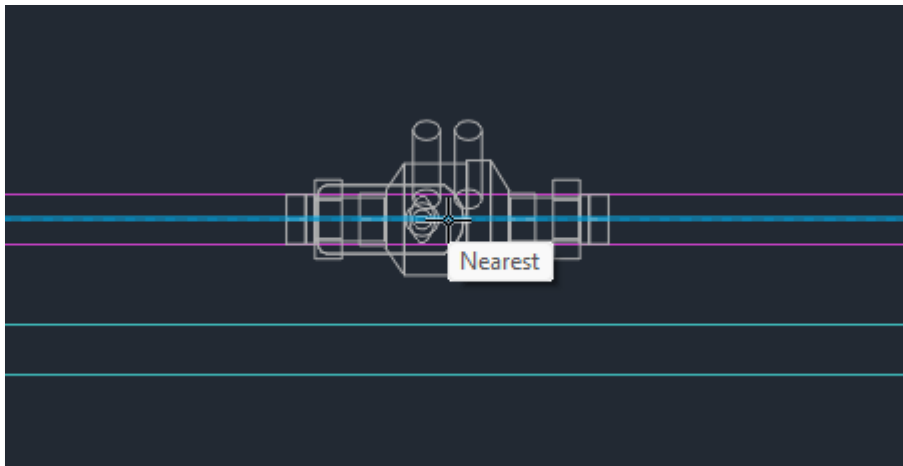

2.2 Import operation

This command opens Windows file explorer file selection dialog where user can select a .MVEF file to import. The valve and actuator file can be exported from the Selection tool with the Insert / Export operation.

If Revit without MagiCAD is used, the plugin creates RFA and the product instance that can be inserted at the desired location.

1. Start the *Import* command from ribbon button.

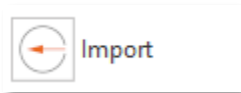

2. Select .MVEF file with the file selection dialog and click Open.

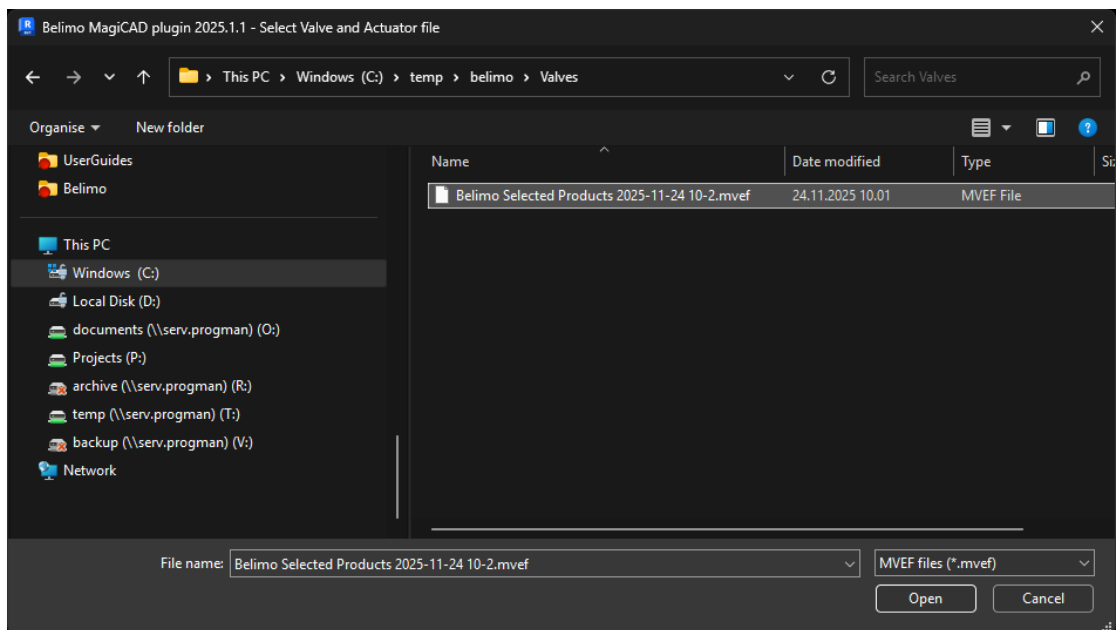

3. After the file is selected, plugin will check the file, and if file is correct the operation continues with the same workflow as described in the product installation chapters 2.1.2 and 2.1.3.