

A decorative background consisting of several nested, light blue geometric shapes that resemble stylized architectural elements or a maze, set against a white background.

# Chiller MagiCAD Cloud Plugin for Revit

13/04/2026

## Content

<b>1</b>	<b>GENERAL</b> .....	<b>3</b>
	About this document.....	3
	Installing the software.....	3
	Before the installation.....	3
	Installation.....	3
	Start and using the application.....	4
<b>2</b>	<b>FUNCTIONS</b> .....	<b>5</b>
	Chiller plugin user interface overview.....	5
	Insert Fan coil operation.....	5
	View documents operation.....	5
	Detailed insert operation.....	6
	Detailed view documents operation.....	15

## 1 General

### About this document

This document contains instructions for using the Chiller MagiCAD plugin for Autodesk Revit. Plugin application is an add-in application in Revit and does not require that MagiCAD is installed. The products installed contains HVAC data which can be utilized only with MagiCAD, so it's recommended that MagiCAD is also installed.

With plugin user can:

- Do the sizing of a product and select Chiller fan coil units in selection tool, based on the system information acquired from the Revit project.
- View the previously selected products and its details in the Chiller selection tool. Download the product specific documentation from the selection tool.

### Installing the software

Chiller MagiCAD plugin for Revit works with the following MagiCAD and Revit versions:

Revit

- Revit 2024-2027

MagiCAD for Revit (optional)

- MagiCAD 2026 with Revit 2024-2026
- MagiCAD 2027 with Revit 2025-2027

### Before the installation

Workstation administrator privileges are recommended for installation.

### Installation

1. Download the plugin installer file from MagiCAD portal to your workstation:  
<https://portal.magicad.com/Download/ProductSearch?searchStr=Chiller&categoryId=3>
2. Run the Chiller MagiCAD for Revit plugin installer on your workstation and follow the instructions in installer.

### **Start and using the application**

The plugin is automatically loaded and is ready to be used once Revit is started next time after the plugin installation.

Before you start using the Chiller plugin, create or open a Revit project. All the necessary ventilation, heating / cooling and sewer systems should be available in the project.

Locate the MagiCAD Connect tab from the Revit ribbon. Once the Chiller plugin is loaded, the Chiller ribbon panel and split button can be found from MagiCAD Connect tab. Split button contains separate buttons for different operations: "Insert Fan coil" and "View documents".

## 2 Functions

### Chiller plugin user interface overview

Chiller plugin contains two different operations.

#### Insert Fan coil operation



With this command user can make the product sizing and selection according to the selected Revit heating and/or cooling systems data in the Chiller selection tool web application.

After the selection user can insert the selected product in to Revit project as a 3D geometry object which contains all the HVAC specific data.

#### View documents operation

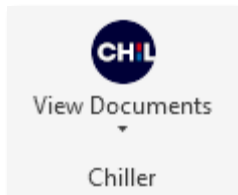

With this command user can view the previous inserted product details in the Chiller selection tool web application in the plugin browser view. User can also download all the product specific design documents from selection tool.

## Detailed insert operation

Pre-requirement for inserting the fan coil product is to have the Revit project with existing heating and/or cooling system. The system media type, supply and return temperatures are used for product selection. With some products also supply ventilation system and drainage system should exist.

Follow these steps to insert the fan coil product to Revit drawing and project. The following steps contains the cooling type fan coil product insert.

1. Start the fan coil insert operation from the button.
2. The fan coil piping systems selection is done from the opened systems selection dialog. The product type (heating / cooling / heating + cooling) will be decided according to the systems selection.

Dialog will check the systems temperatures and informs to user if the selection is not correct. In case of heating systems the supply temperature must be bigger than the return temperature. In case of cooling systems the supply temperature must be lower than the return temperature.

After systems selection, continue with OK button.

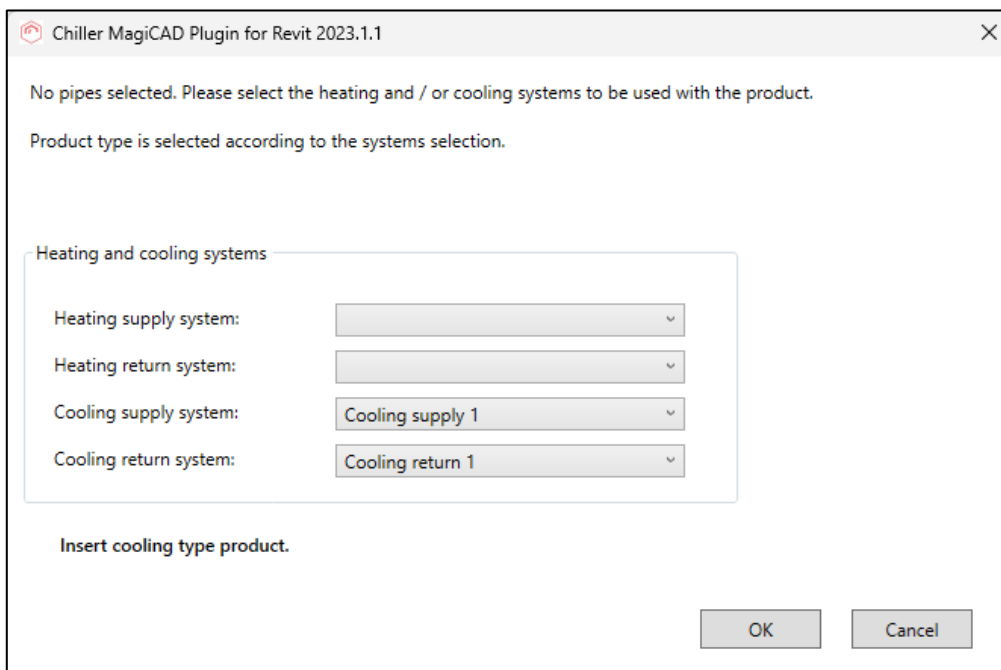

Chiller MagiCAD Plugin for Revit 2023.1.1

No pipes selected. Please select the heating and / or cooling systems to be used with the product.  
Product type is selected according to the systems selection.

Heating and cooling systems

Heating supply system:

Heating return system:

Cooling supply system:

Cooling return system:

Insert cooling type product.

OK Cancel

3. Plugin will open the Chiller selection tool application in its browser view and user can select the product family.

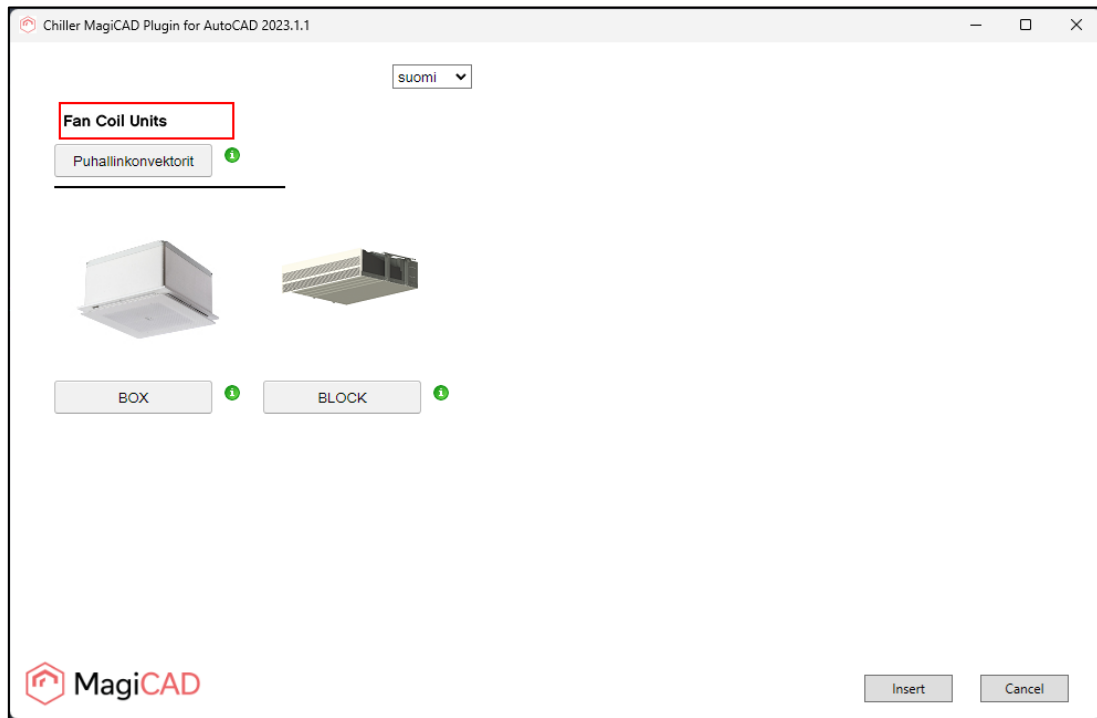

- After the family is selected, user selects the product model or variant. Finally, user selects the unit for the product variant. The liquid should be selected before the unit selection. The media field indicates the MagiCAD system specific media name. This helps the user to select the correct media for the product.

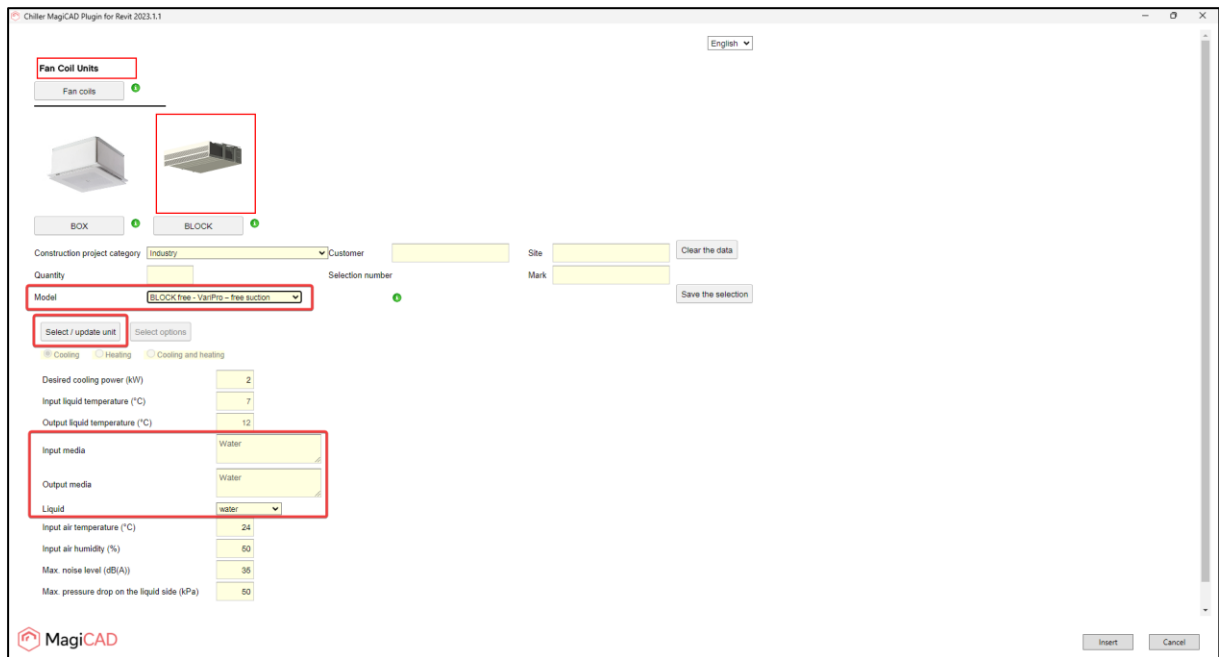

5. After all needed selection are done, user saves the selection. Selection web application informs user when the selection has been saved. User inserts the selected product to Revit with Insert button.

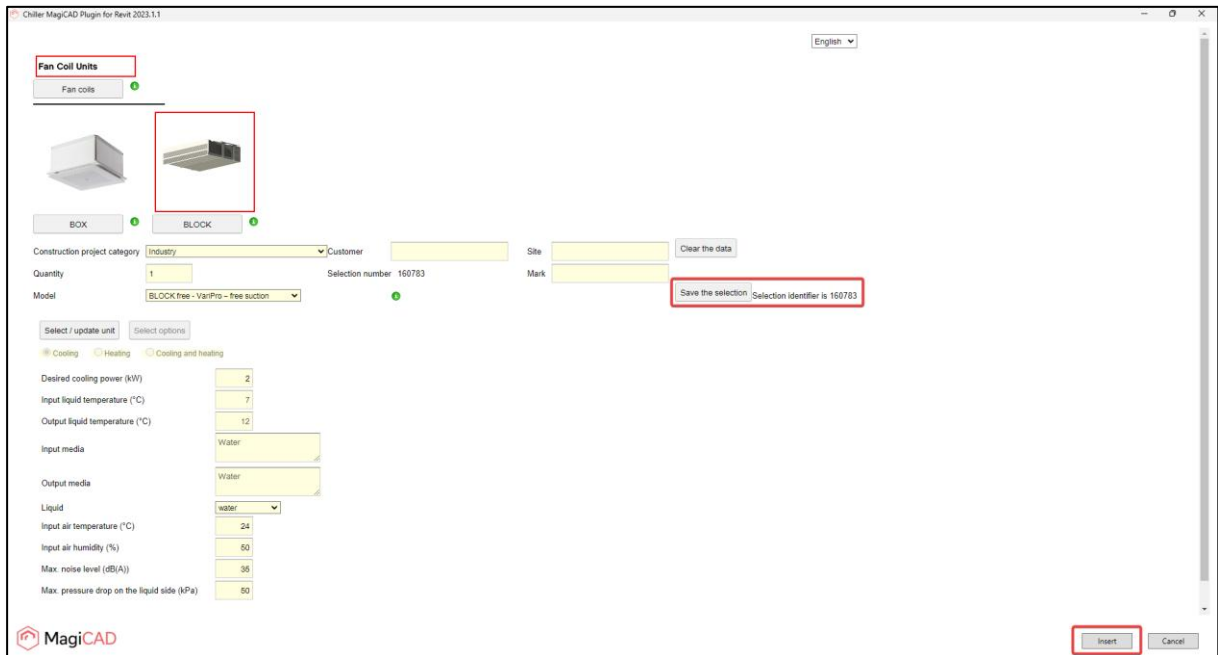

6. Plugin gets all the product related data and shows the product insert dialog for the user. In the dialog user will:
  - a. In System column, select the ventilation system for the product. In case product contains a fresh air ventilation connection it will be connected to the same system.
  - b. See the calculated cooling power.
  - c. See the Revit supply and return cooling systems.
  - d. Select the drainage system for the product (in case product needs the drainage connection).
  - e. Select the installation height level.

User inserts the product to drawing with Insert button. Plugin creates the needed Revit families after Insert button click.

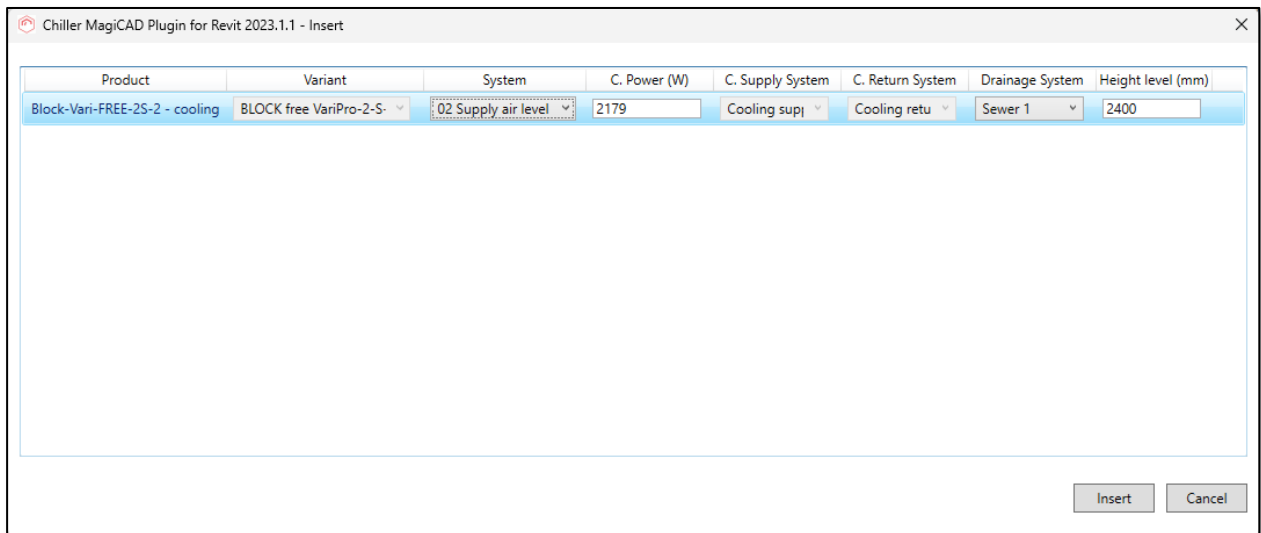

Product	Variant	System	C. Power (W)	C. Supply System	C. Return System	Drainage System	Height level (mm)
Block-Vari-FREE-2S-2 - cooling	BLOCK free VariPro-2-S	02 Supply air level	2179	Cooling sup	Cooling retu	Sewer 1	2400

7. User selects the position and the rotation for the product in the drawing. Single or multiple product instances can be added. Note that in some products the installation point can be right on top and in Revit the product level is 0 mm during the dragging. This might lead to situation where product is not visible while dragging. This can be adjusted from Revit View Template and View Range settings.

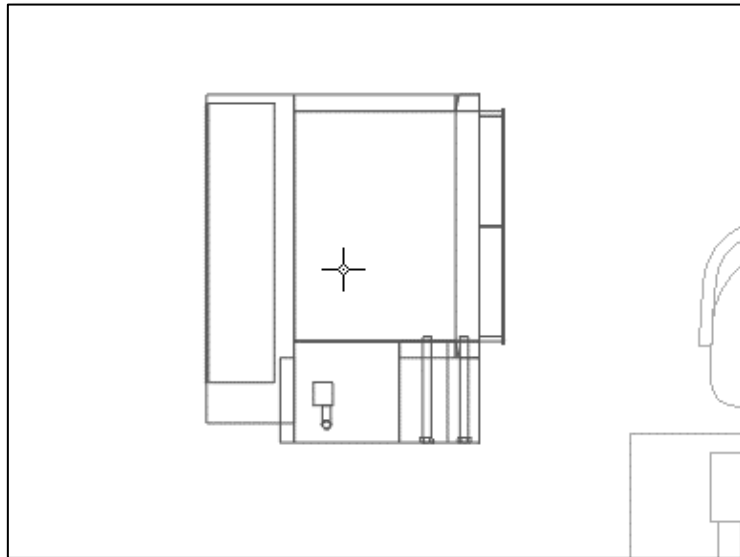

8. After the product(s) are positioned and rotated, plugin will create the final Revit specific product assembly. Note that in some cases the assembly creation is not necessary.

With Revit assembly, user can access the main product connectors (heating pipes, cooling pipes and electrical connector) when product is selected by clicking the keyboard tab key and click the product again with mouse button. Drainage connector can be accessed when product is selected by going over the drainage connector, push the tab key and click the connector.

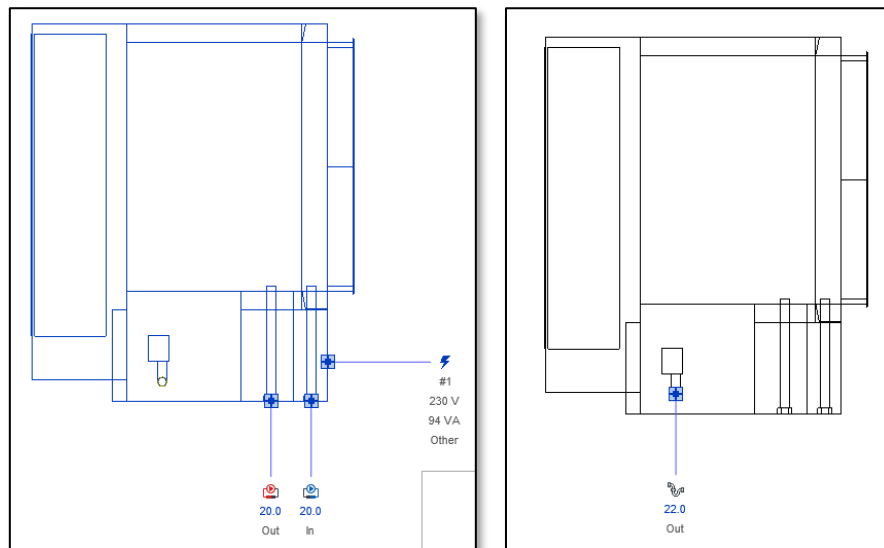

9. Connect the product to existing cooling pipework and drainage pipework. Note that some products are also connected to heating pipework and / or ventilation ductwork.

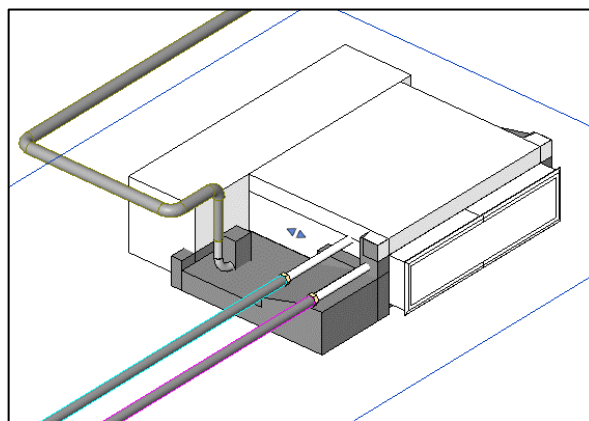
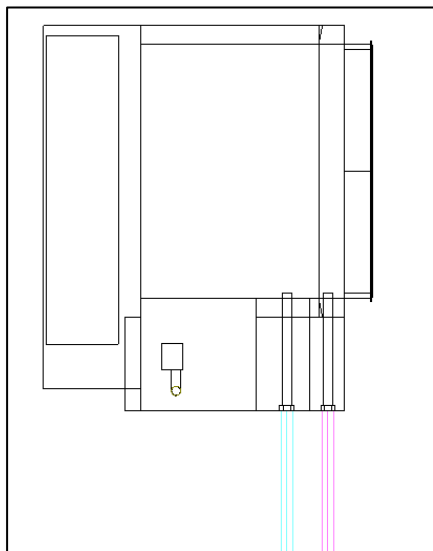

10. Run the MagiCAD balancing calculation to see from the report if the product is in balance with the rest of the pipework.

MagiCAD - Hydronic Network Balancing Report

Edit

Supply       General results

Return

Location	Level	Node	Type	Series	Product	Size	L [m]	Insulatio	P [W]	qv [l/s]	v [m/s]	T [°C]	Q [W]	dp/L [Pa/m]	dpt [kPa]	K factor	pt [kPa]	adj.	Warnings
	Level 1		PIPE	Fe-35	MAGI-FE-8	80	0.3		48579	2.384	0.45	7.0	-2.2	30.9	0.0		36.0		
	Level 1		BEND-90	Fe-35	MAGI-FE-B	80			48579	2.384	0.45				0.0	0.493	36.0		
	Level 1		PIPE	Fe-35	MAGI-FE-8	80	0.8		48579	2.384	0.45	7.0	-6.5	30.9	0.0		35.9		
	Level 1		BEND-90	Fe-35	MAGI-FE-B	80			48579	2.384	0.45				0.0	0.492	35.9		
	Level 1		PIPE	Fe-35	MAGI-FE-8	80	1.2		48579	2.384	0.45	7.0	-9.6	30.9	0.0		35.9		
	Level 1	66	BRANCH	Fe-35	MAGI-FE-T	80/20			48579	2.384	0.45				0.1	1.000	35.8		
	Level 1		PIPE	Fe-35	MAGI-FE-2	20	0.8		2179	0.107	0.27	7.0	-2.0	69.3	0.1		35.7		
	Level 1		BEND-90	Fe-35	MAGI-FE-B	20			2179	0.107	0.27				0.0	0.480	35.7		
	Level 1		PIPE	Fe-35	MAGI-FE-2	20	0.4		2179	0.107	0.27	7.0	-0.9	69.3	0.0		35.7		
	Level 1	67	ZONE VAL	Fe-35	9585 DN2	20			2179	0.107						2.0		35.6	3,3
	Level 1		PIPE	Fe-35	MAGI-FE-2	20	1.2		2179	0.107	0.27	7.0	-3.0	69.3	0.1		33.6		
	Level 1	68	FAN COIL		BLOCK fre	20			2179	0.107		7.0			27.6		33.6		

Previous warning/error      Next warning/error

## Detailed view documents operation

Pre-requirement for viewing the fan coil product documents is to have the Revit project with existing fan coil product which is inserted with the plugin functionality.

Follow these steps to view the fan coil product documents in the Chiller selection application.

1. Start the View Documents operation from the button.
2. Plugin asks for user to select the product which documents should be viewed. The command can be cancelled with keyboard Esc button.
3. After selecting the product, plugin will open the product specific page from the selection application. User makes the reports in the page with Make a report button. User can load for example the operating diagram which will be opened to users default pdf viewer. In other formats, the Windows Save As.. dialog will be shown to user and user can select where to save the file.

The viewing of the documents is ended with OK button.

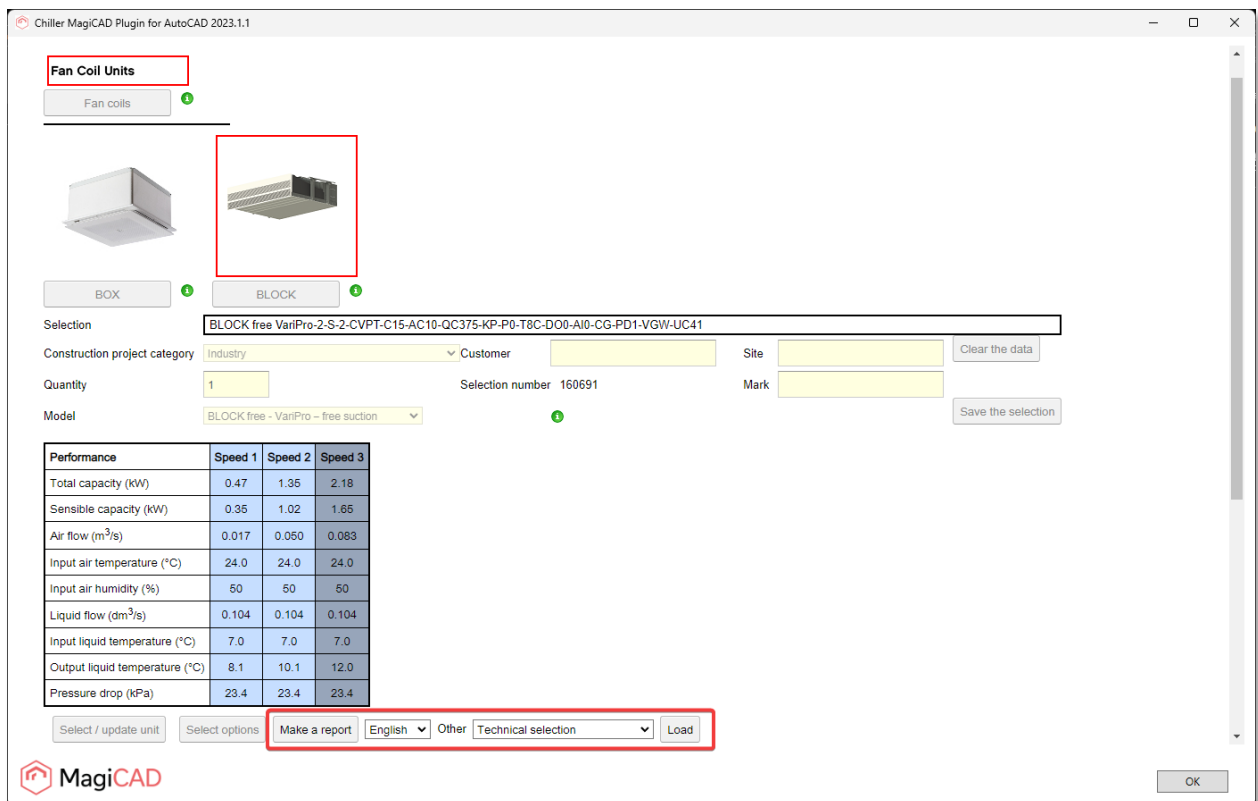

Chiller MagiCAD Plugin for AutoCAD 2023.1.1

**Fan Coil Units**

Fan coils

BOX BLOCK

Selection: BLOCK free VariPro-2-S-2-CVPT-C15-AC10-QC375-KP-P0-T8C-DO0-AI0-CG-PD1-VGW-UC41

Construction project category: Industry Customer Site Clear the data

Quantity: 1 Selection number: 160691 Mark Save the selection

Model: BLOCK free - VariPro - free suction

Performance	Speed 1	Speed 2	Speed 3
Total capacity (kW)	0.47	1.35	2.18
Sensible capacity (kW)	0.35	1.02	1.65
Air flow (m <sup>3</sup> /s)	0.017	0.050	0.083
Input air temperature (°C)	24.0	24.0	24.0
Input air humidity (%)	50	50	50
Liquid flow (dm <sup>3</sup> /s)	0.104	0.104	0.104
Input liquid temperature (°C)	7.0	7.0	7.0
Output liquid temperature (°C)	8.1	10.1	12.0
Pressure drop (kPa)	23.4	23.4	23.4

Select / update unit Select options Make a report English Other Technical selection Load

MagiCAD OK