



Repus MagiCAD Cloud Plugin for Revit

13/04/2026

Content

1	GENERAL	3
	About this document.....	3
	Installing the software.....	3
	Before installation.....	3
	Installation.....	3
	Starting the plugin application.....	4
2	FUNCTIONS	5
2.1	Repus plugin UI overview.....	5
2.1.1	Select nozzle duct.....	5
2.1.2	Select displacement diffuser.....	5
2.2	Detailed Select nozzle duct function.....	6
2.3	Detailed Select displacement diffuser function.....	10
3	PRODUCT INSTALLATION IN REVIT	11
3.1	Installation with MagiCAD.....	11
3.2	Installation without MagiCAD.....	14

1 General

About this document

This document contains the information on the installation and the using of Repus MagiCAD plugin for Revit. Repus plugin is Autodesk Revit add-in application and it works with MagiCAD for Revit and with plain Revit.

With Repus MagiCAD plugin for Revit user is able

- To do the sizing and calculations of the ventilation nozzle ducts and displacement diffusers.
- To download the product documentation after the sizing.
- To insert the calculated products as 3D models to the Revit project.

Installing the software

Repus MagiCAD plugin for Revit works with the following MagiCAD versions:

Revit

- Revit 2024-2027.

MagiCAD for Revit (optional)

- MagiCAD for Revit 2026 with Revit versions 2024-2026.
- MagiCAD for Revit 2027 with Revit versions 2025-2027.

Before installation

Workstation administrator privileges are recommended for installation.

Installation

1. Download the installer file Repus plugin for Revit and MagiCAD from MagiCAD portal to your workstation:

<https://portal.magicad.com/Download/ProductSearch?searchStr=Repus&categoryId=3>

2. Run the Repus MagiCAD plugin for Revit and MagiCAD installer on your workstation and follow the instructions from installer.

Starting the plugin application

The plugin is automatically loaded and is ready to be used once Revit is started next time after the plugin is installed.

Locate the MagiCAD Connect tab from the Revit ribbon panel. Once the Repus MagiCAD plugin is loaded its ribbon panel and buttons can be found from MagiCAD Connect tab.

When the upper part of the button is clicked the corresponding operation will be started. When the lower part of button is clicked, it opens the rest of the functions. On mouse over the button, the plugin gives some extra information about the functionality.

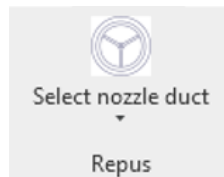

Figure 1 Repus plugin ribbon panel and split button

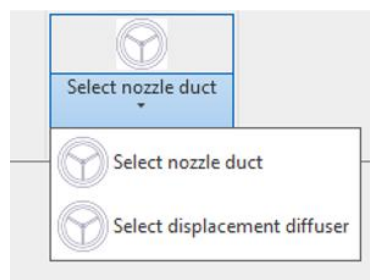
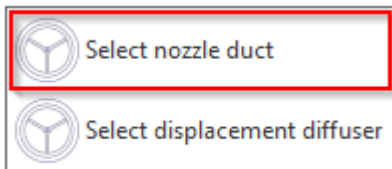

Figure 2 Repus plugin operations in split button

2 Functions

2.1 Repus plugin UI overview

2.1.1 Select nozzle duct



With this command user is able to select the Repus nozzle duct from selection tool, calculate and customize it, save a documentation of it and insert a 3D model of the product in the Revit project.

2.1.2 Select displacement diffuser

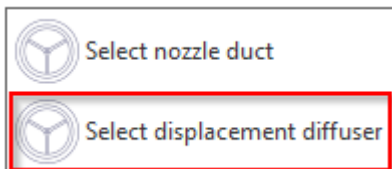

With this command user is able to select the Repus displacement diffuser from selection tool, calculate and customize it, save a documentation of it and insert a 3D model of the product in the Revit project.

2.2 Detailed Select nozzle duct function

1. Start the nozzle duct selection operation by clicking the button from Repus ribbon panel. Plugin opens the Repus selection tool with the view of all nozzle duct family types available.

Select the product family type and selection tool proceeds to the product configuration page.

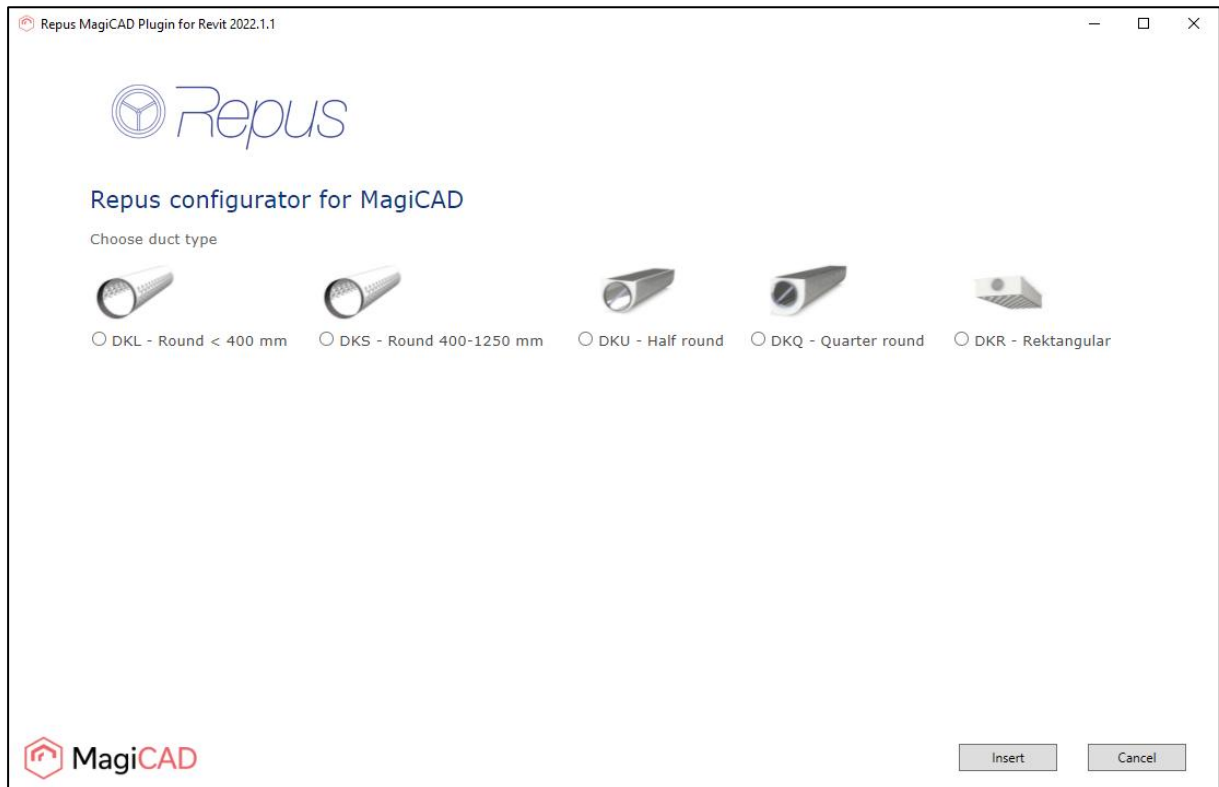

2. In the product configuration page, set all the input data for the product calculation and proceed to product calculation with the Next button.

Repus MagiCAD Plugin for Revit 2022.1.1



Configure duct

Step 1 - indata

Spreading

Semi integrated in roof
 Free 1 way
 Free 2 way

Length A (m)

Connection diameter D (mm)

End velocity jet (m/s)

Delta temp (° C)

Max noise level Units

Air flow Units

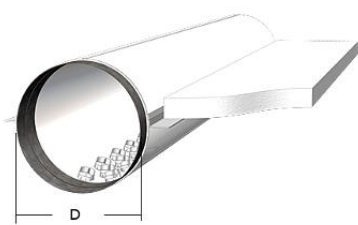



- After the product calculation is done, the calculation results are shown. Click the Finish button to proceed to the final phase where selection tool generates the files.

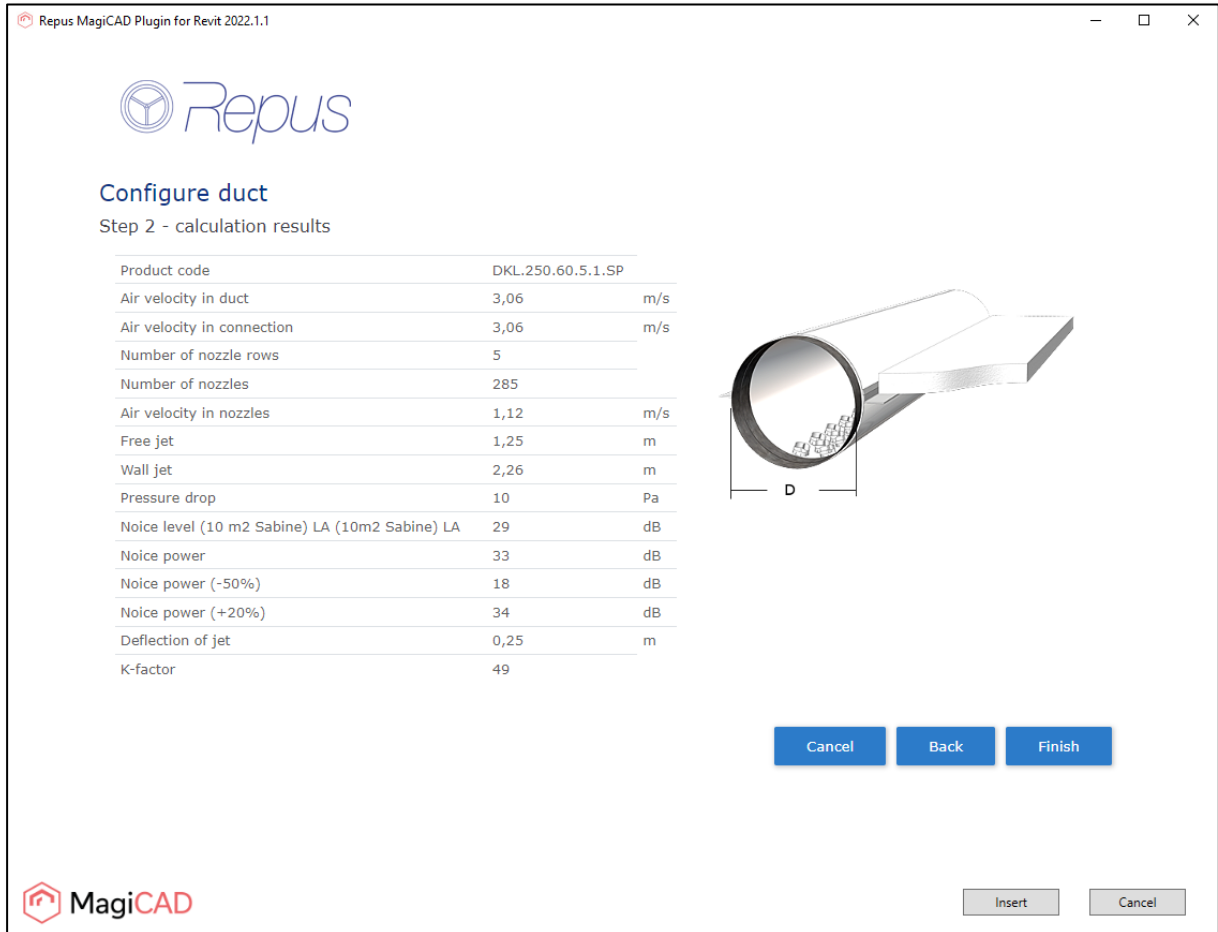

Repus MagiCAD Plugin for Revit 2022.1.1

Repus

Configure duct
Step 2 - calculation results

Product code	DKL.250.60.5.1.SP	
Air velocity in duct	3,06	m/s
Air velocity in connection	3,06	m/s
Number of nozzle rows	5	
Number of nozzles	285	
Air velocity in nozzles	1,12	m/s
Free jet	1,25	m
Wall jet	2,26	m
Pressure drop	10	Pa
Noise level (10 m2 Sabine) LA (10m2 Sabine) LA	29	dB
Noise power	33	dB
Noise power (-50%)	18	dB
Noise power (+20%)	34	dB
Deflection of jet	0,25	m
K-factor	49	

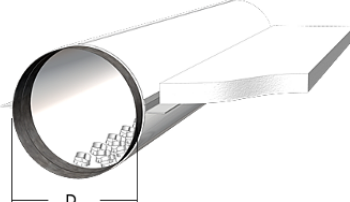

Buttons: Cancel, Back, Finish

Buttons: Insert, Cancel

MagiCAD

4. In the final page, download the product specification if it's necessary. Proceed to product insert to Revit project with the Insert button. When Insert button is selected, plugin closes the Repus selection tool and loads the configured product.

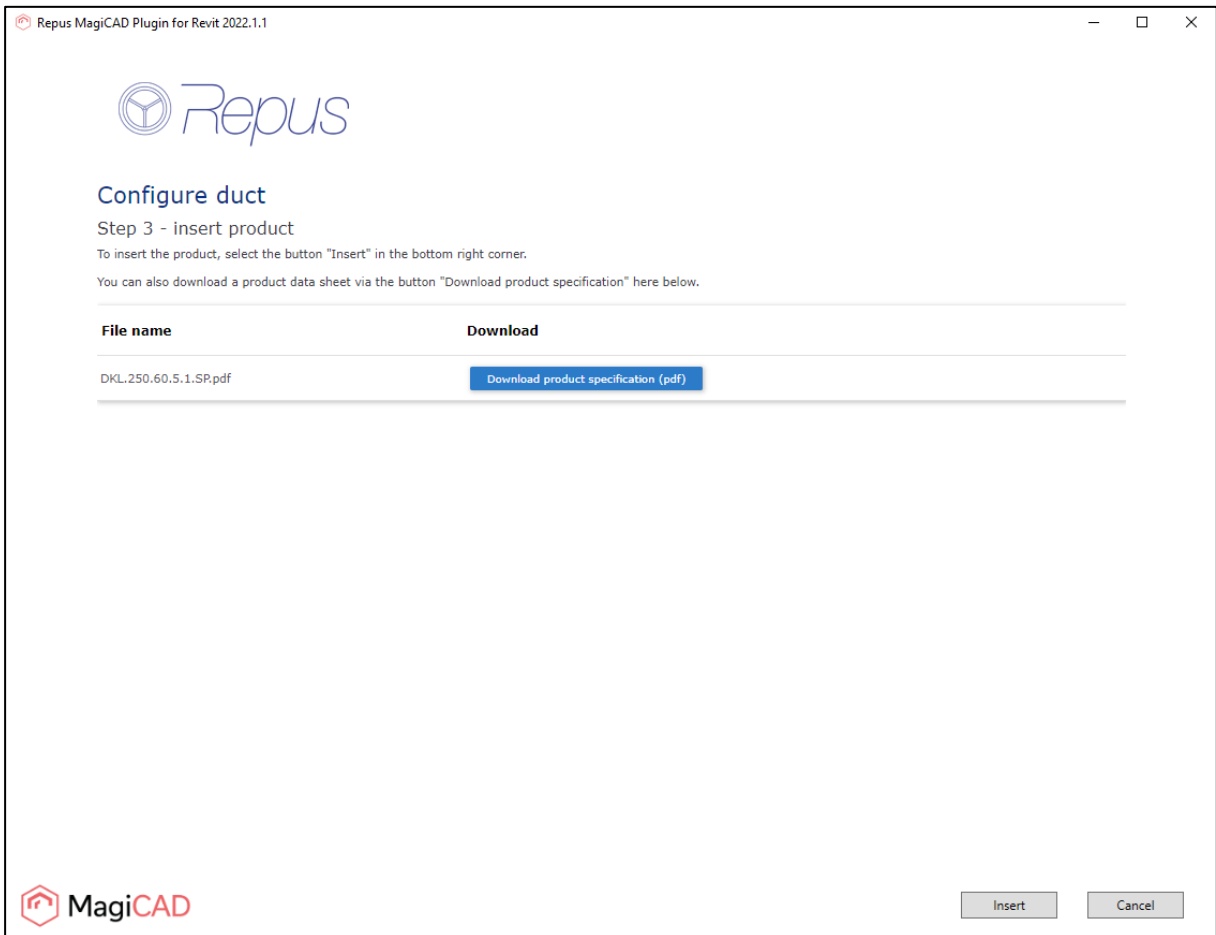

5. For product installation in Revit with MagiCAD installed, continue to chapter 3.1.
For product installation in Revit without MagiCAD installed, continue to chapter 3.2.

2.3 Detailed Select displacement diffuser function

Start the displacement diffuser selection operation by clicking the button from Repus ribbon panel. Plugin opens the Repus selection tool with the view of all diffuser family types available.

Select the product family type and selection tool proceeds to the product configuration page.

The basic workflow for the diffusers selection and installation is the same as with the nozzle ducts, follow the workflow from chapter 2.2.

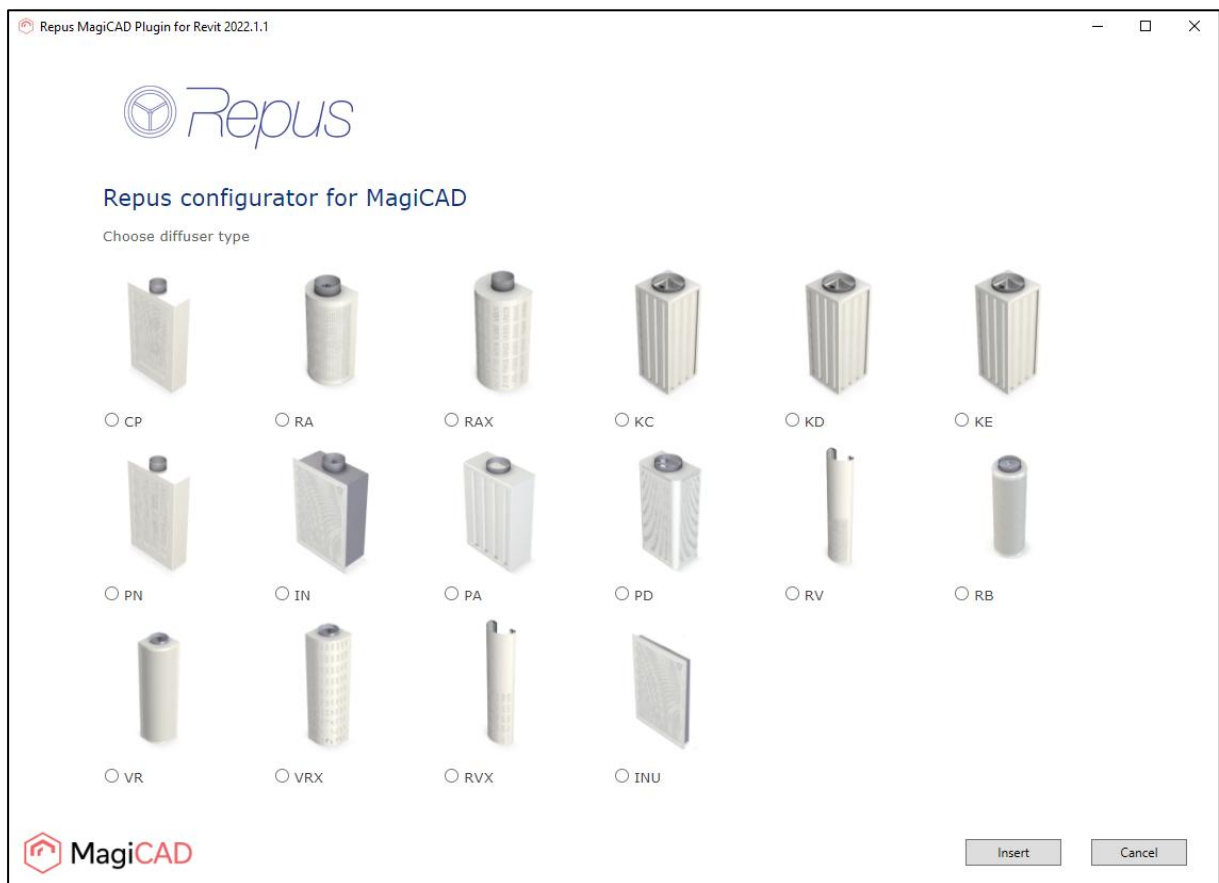

3 Product installation in Revit

3.1 Installation with MagiCAD

1. After the product is loaded and if MagiCAD is installed, plugin uses MagiCAD features for product installation. The product is added to MagiCAD dataset and Dataset Properties dialog is opened where it's possible to set all the data for the product like for example 2D symbols. Set the data and proceed to MagiCAD Product Selection dialog with OK button.

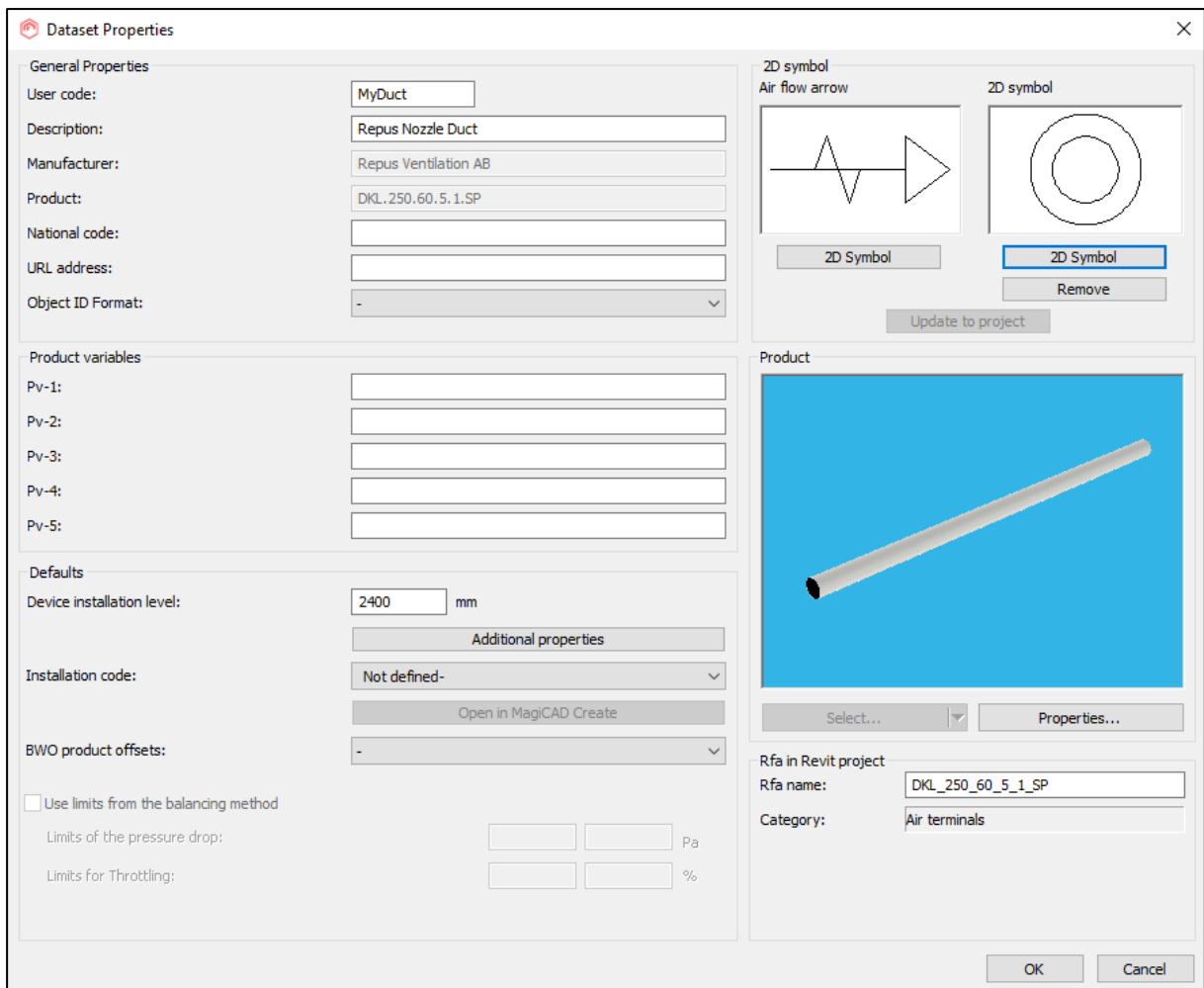

- In the MagiCAD Product Selection dialog user gives the air flow value for the product. Value can be given by writing it to the text box or by clicking the point from the pressure drop curve. Product specific sound power levels (dB) are also visible in this dialog. Proceed to product Revit family creation and installation with the Select button.

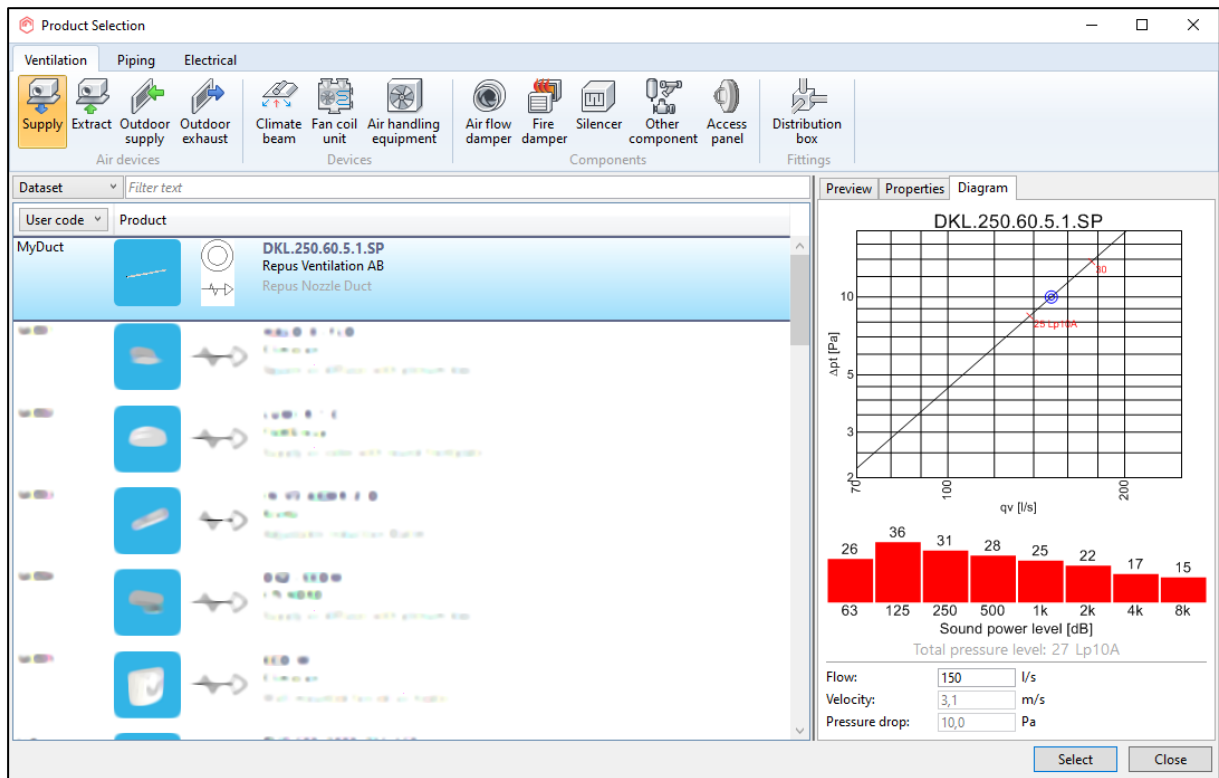

Product Selection

Ventilation Piping Electrical

Supply Extract Outdoor supply Outdoor exhaust Climate beam Fan coil unit Air handling equipment Air flow damper Fire damper Silencer Other component Access panel Distribution box

Air devices Devices Components Fittings

Dataset Filter text

User code Product

MyDuct

DKL.250.60.5.1.SP
Repus Ventilation AB
Repus Nozzle Duct

Preview Properties Diagram

DKL.250.60.5.1.SP

Δp_t [Pa]

qv [l/s]

26 36 31 28 25 22 17 15

63 125 250 500 1k 2k 4k 8k

Sound power level [dB]

Total pressure level: 27 Lp10A

Flow: 150 l/s
Velocity: 3,1 m/s
Pressure drop: 10,0 Pa

Select Close

- After the product Revit family is created, the MagiCAD Product Installation dialog is opened. Finalize the product installation to project by dragging and dropping the product in to design and using the MagiCAD dialog. After the installation, the product can be connected to the ductwork. The product related data is visible in the MagiCAD specific ventilation calculations when those are performed.

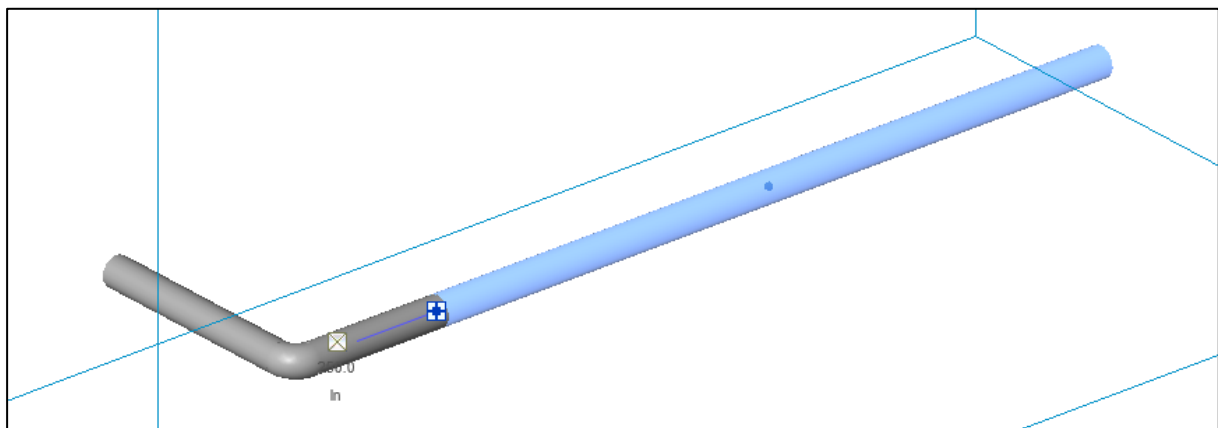
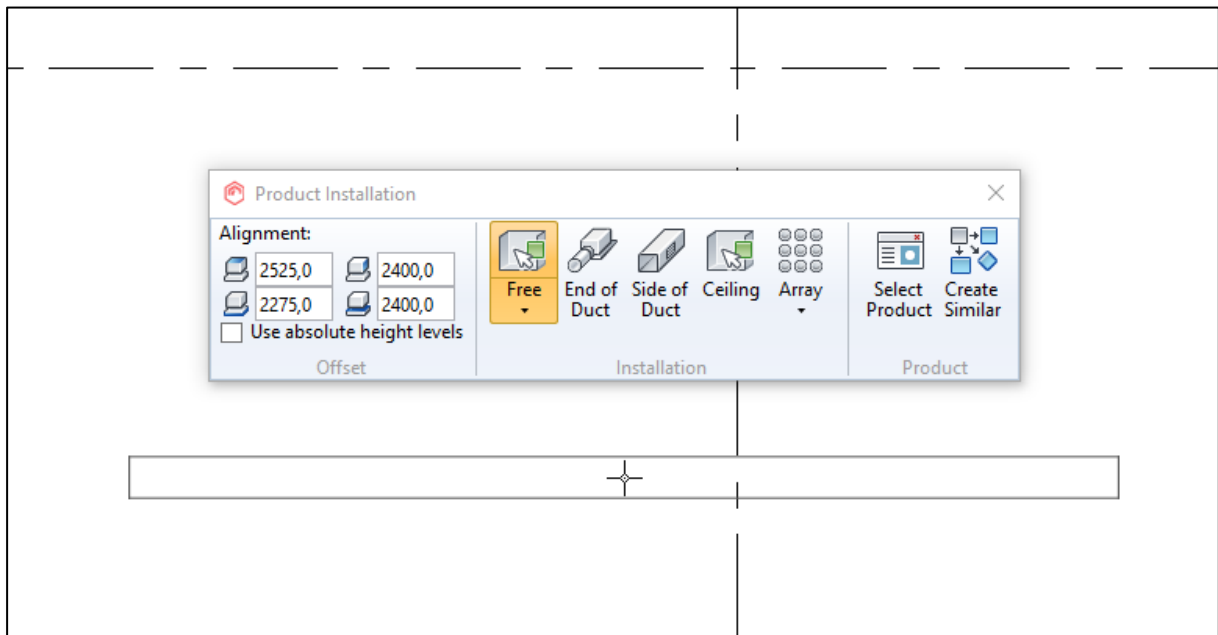

3.2 Installation without MagiCAD

1. In case where MagiCAD is not installed the plugin shows the product insert dialog. In this dialog it's possible to select the ventilation system where the product is attached, the airflow and height level for the product. The values are written to Revit family parameters of the product and it's possible to modify these after the installation.

Proceed the Revit family creation and product installation with the Insert button.

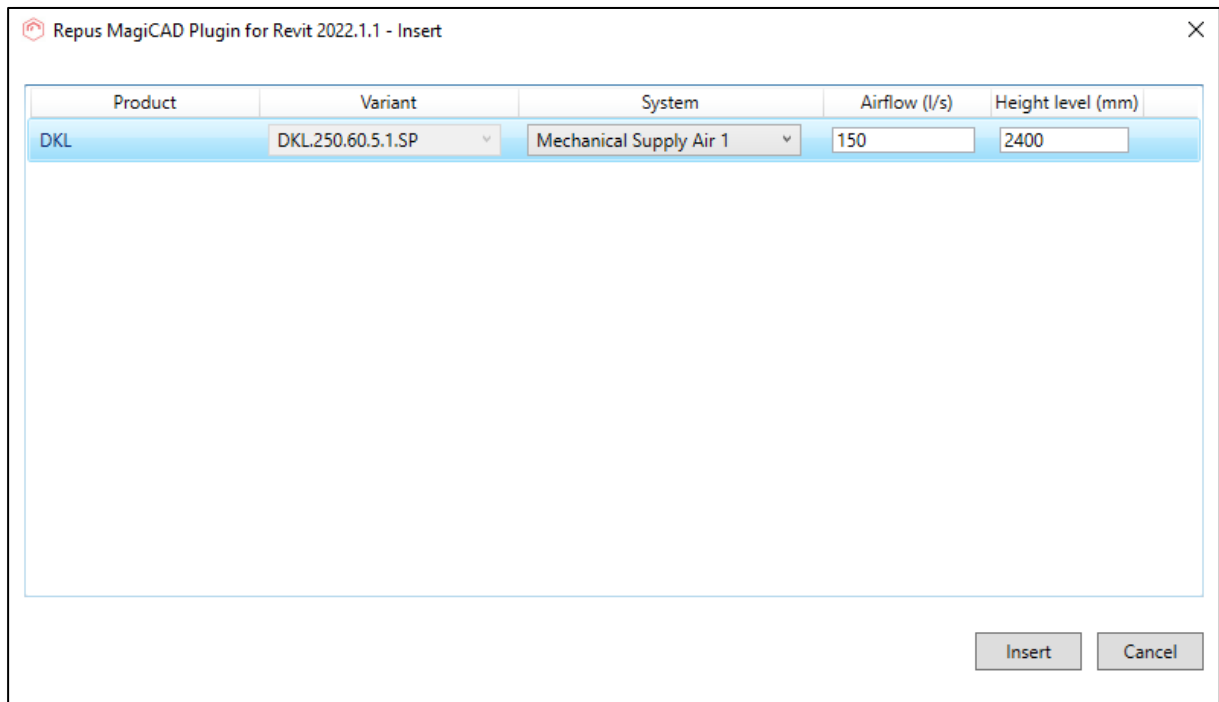

Product	Variant	System	Airflow (l/s)	Height level (mm)
DKL	DKL.250.60.5.1.SP	Mechanical Supply Air 1	150	2400

2. After the product family is created the product can be dragged and dropped to design. Finalize the product installation and after the installation, the product can be connected to the ductwork.

