



Novema Revit Plugin

User guide

14/04/2020

Content

1	CHAPTER 1. GENERAL	3
1.1	About this document.....	3
1.2	Installing the software.....	3
1.2.1	Required third-party software.....	3
1.2.2	Installation	3
1.3	Adding unit to Revit	4

1 Chapter 1. General

1.1 About this document

This document contains instructions on using Novema Revit plugin.

The purpose of the plugins to add Novema air handling units selected with Novagg dimensioning program into MagiCAD for Revit or Revit project and drawing.

1.2 Installing the software

1.2.1 Required third-party software

Revit

- Revit 2018, 2019, 2020, 2021

MagiCAD (optional)

- MagiCAD for Revit 2020 (with Revit 2018, 2019, 2020)
- MagiCAD for Revit 2021 (with Revit 2019, 2020, 2021)

1.2.2 Installation

Novema Revit plugin can be used without Novagg program. It is assumed that user has received .nvcd -file from some Novagg user.

Administrator privileges are recommended for installations.

Install Novema Revit plugin.

64-bit installation package can be downloaded from:

<https://portal.magicad.com/download/ProductSearch?searchStr=Novema&categoryId=3>

1.3 Adding unit to Revit

If you have the newest Novagg version, you may create Revit-file with the newest Novagg version.

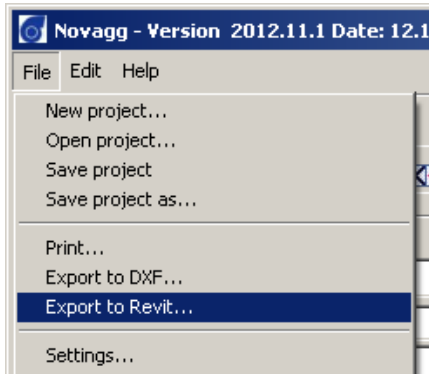

Note, that .nvcd-file will contain only one unit. In this case it would be unit number 2 because it is selected.

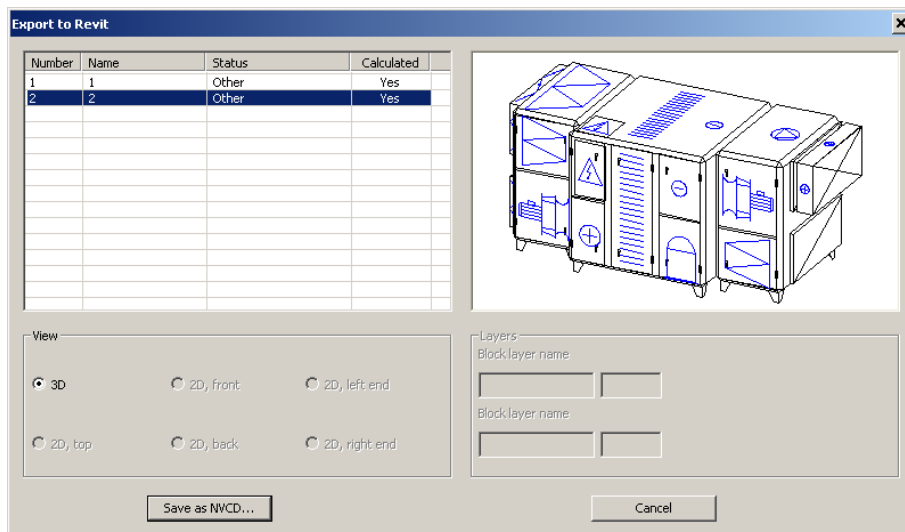

1. Select *Add-Ins* ribbon tab and *Air Handling Unit* ribbon button



2. Select .nvcf-file from the folder you have the .nvcf –file and press Open. Unit will be imported to Revit.

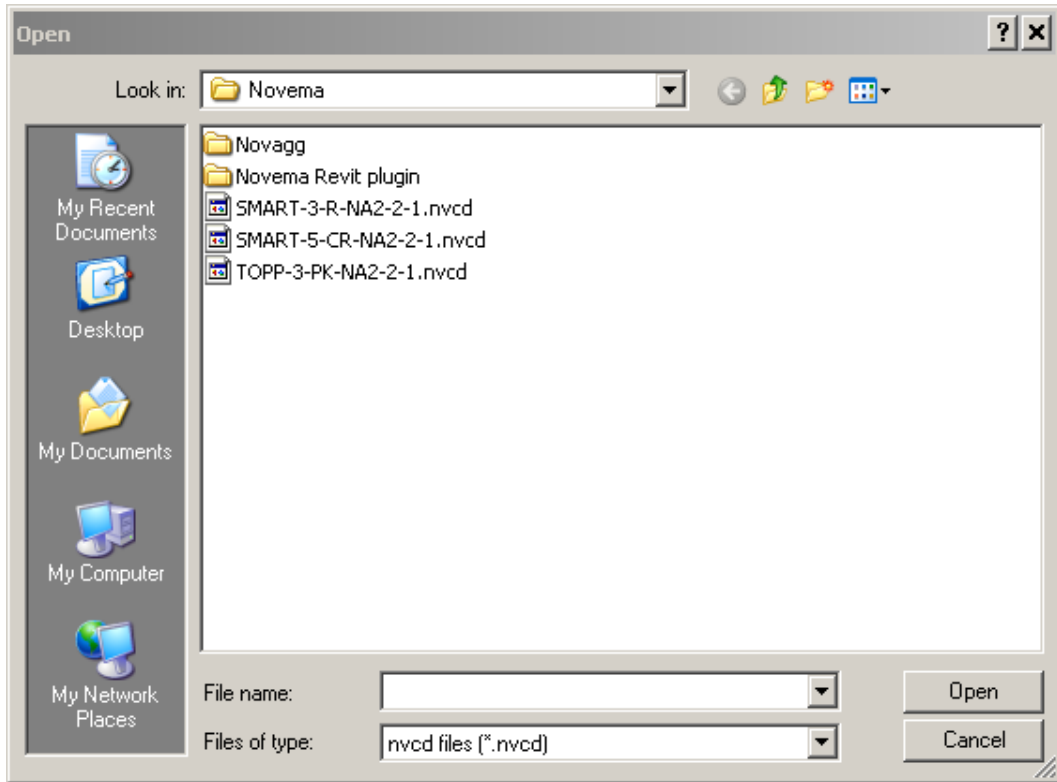

3. Unit is placed to Mechanical Equipment group in Revit. You can see unit information when you click Edit type in Properties dialog. Now you can continue working with MagiCAD for Revit / Revit.

